

2014 LIFE CYCLE ASSESSMENT OF U.S. AVERAGE CORRUGATED PRODUCT EXECUTIVE SUMMARY

ES.1 Background and Objective

The Corrugated Packaging Alliance (CPA), a joint venture of the American Forest & Paper Association (AF&PA), Fibre Box Association (FBA), AICC, The Independent Packaging Association (AICC) and TAPPI, have commissioned NCASI to conduct a life cycle assessment (LCA) study of the 2014 U.S.-average corrugated product. There were three main objectives to the study:

- 1) To educate customers and stakeholders about the environmental attributes of the industry's corrugated packaging produced in 2014;
- 2) To contrast, to the extent possible, the updated results with those of 2006 and 2010; and
- 3) To present the environmental performance of a corrugated product made of 100%-recycled fiber relative to that of the industry average recycled content.

This study was performed following the principles described in the ISO 14040/14044 standards for a publicly disclosed study.

The study being an update of the 2010 LCA published in 2014, it was reviewed by one external reviewer instead of a panel. The reviewer was Lindita Bushi from Athena Institute. The critical review in no way implies that the reviewer endorses the results of the LCA study, nor that they endorse the assessed products. It ensures that the study, among other requirements, was carried out per the provisions of the ISO standards.

ES.2 Products Studied

Four different products manufactured and used in the U.S. were studied in this assessment:

1. The 2014 U.S. industry-average corrugated product (main product studied in this LCA);
2. The 2010 U.S. industry-average corrugated product;
3. The 2006 U.S. industry-average corrugated product; and
4. The 2014 U.S. industry-average corrugated product made from 100%-recycled fiber (often referred to in this study as the 100%-recycled product).

Corrugated products (for instance corrugated boxes) are made of corrugated board (combined board). Corrugated board is the structure formed by bonding one or more sheets of fluted corrugating medium to one or more flat facings of linerboard.

The 2014 U.S.-average corrugated product studied in this LCA consists of 66.8% linerboard and 33.2% corrugated medium with an average basis weight of 131.6 lb/thousand square feet (msf, 0.643 kg/m²). The industry-average containerboard utilizes about 52%¹ recovered fiber, primarily old corrugated containers (OCC), with the balance supplied mostly by kraft and semi-chemical pulp. More information regarding the 2010 and 2006 product can be found in the LCA reports from prior assessments (<http://www.corrugated.org/ViewPage.aspx?ContentID=36> and <http://www.corrugated.org/upload/CPALCAfinalreport08-25-10.pdf>, respectively). ISO 14044 requires that whenever two products are compared, these should be functionally equivalent. For that reason, the 100%-recycled product studied in this study and compared to the industry-average was modeled using the same board mix (linerboard to medium ratio). It was also assumed that the 100%-recycled product had the same basis weight as the industry-average product.

ES.3 The Study Design and Methods Employed

The functional unit for the study was *"the domestic use of 1 kg of an average corrugated product produced in the U.S. in 2014."* The system boundary included the entire life cycle of the corrugated product, extending through manufacturing, use, recovery, and end of life, as shown in Figure 1. The product system was separated into four life cycle stages:

- 1) **Pulp and papermaking operations** includes forest operations, transportation of wood to chipping, off-site chipping, on-site production of chips, off-site production of market pulp, production of on-site produced pulp, papermaking operations (to produce containerboard), conversion into rolls, and supporting activities (on-site steam and power production, on-site chemical production, effluent treatment, on-site waste management, etc.).
- 2) **Converting** includes the activities involved in converting the linerboard and corrugating medium into corrugated packaging.
- 3) **Use** includes transportation to the use phase, but does not include energy and resources used during the use life cycle stage or the waste generated from use other than the product itself.
- 4) **End-of-life** includes end-of-life management of the packaging product (landfilling, burning with energy recovery).

Each life cycle stage is supplied by resources and necessitates residual management. Transportation between two life cycle stages is included in the downstream stage.

¹ This number is higher than that reported by AF&PA (2015). AF&PA's number (47%) include containerboard produced in the U.S. irrespective of whether it is used domestically or exported. The utilization rate of 52% reflects the fact that fewer 100%-recycled products are exported than other types of products, making the domestic utilization rate higher.

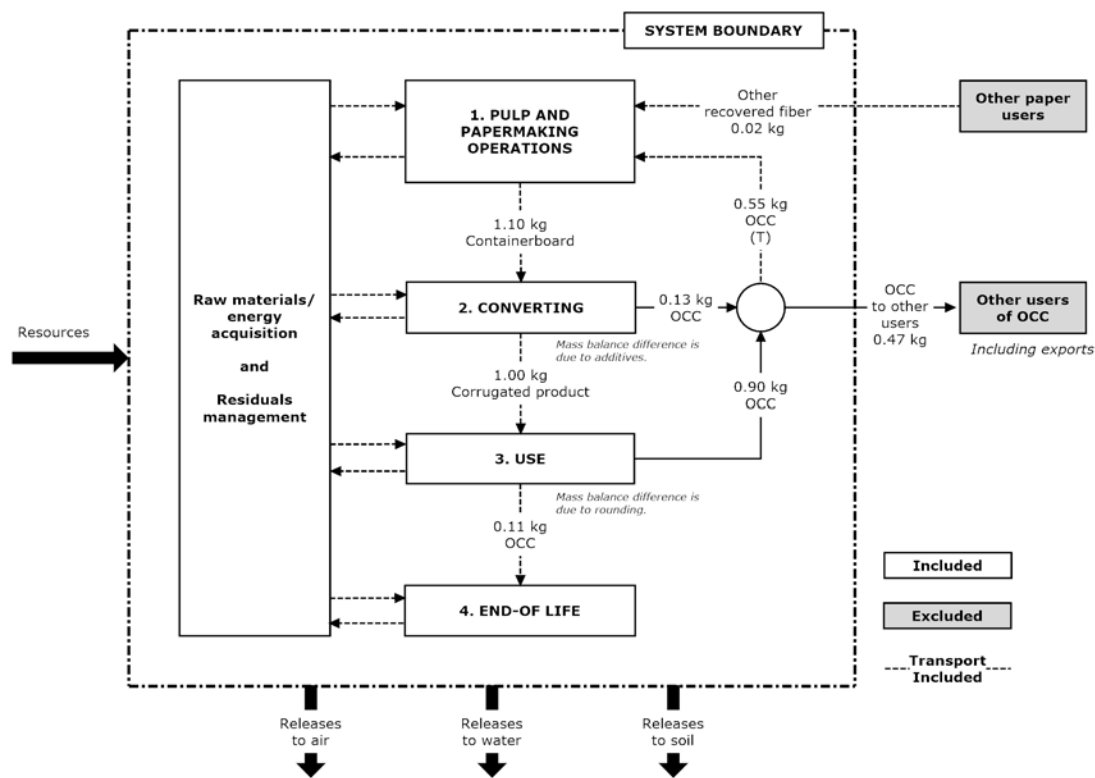

Figure 1. System Boundary

Instead of applying cut-off criteria for data completeness, attempts have been made to be as comprehensive as possible. The data for the study were obtained from the following sources.

- Data on water inputs, environmental loads, solid waste management, and energy (quantity and types of fuels) for the relevant pulp and paper mills were drawn from responses to the 2014 AF&PA Environmental, Health, and Safety Survey.
- Information on quantity of energy used, fiber input, furnish production, and chemical consumption (quantity and type) at the department level was collected in a supplemental survey.
- Data regarding the emissions of toxic substances (as defined by the U.S. Toxic Release Inventory) were modeled using U.S. LCI and NCASI information.
- Data on nutrient content of treated wastewater effluents from pulp and paper mills were derived from available information in the U.S. EPA Permit Compliance System database (www.epa.gov/enviro/html/pcs/); these data are insufficient to allow characterization of effluents from the specific mills in the database, but they do allow general characterization of effluents from U.S. pulp and paper mills.
- Data submitted by the industry in connection with the TSCA Inventory Update Rule (IUR, www.epa.gov/iur/) were used to estimate quantities of kraft pulping co-products (e.g., turpentine and tall oil) produced; the IUR data were not sufficient to characterize every mill in the database, but were sufficient to characterize kraft pulping processes in general.
- Converting facilities in the U.S. were surveyed to collect energy and material input, production, and environmental release information.

- Data and models for other aspects of the life cycle (e.g., for landfills) were obtained from a number of government sources, public life cycle databases (U.S. LCI, GaBi, *ecoinvent*), and published studies.

Where allocation was needed to address co-products, the allocation was done using what was considered to be the most suitable method available, with alternative methods being used in sensitivity analyses, as appropriate.

The investigated product system is a hybrid of a closed-loop and open-loop product system because both closed-loop and open-loop recycling occur in the product system. Recycling of converting wastes and old corrugated containers within containerboard production can be described as closed-loop recycling, while imports and exports of recovered fiber to and from the investigated product system are cases of open-loop recycling. An allocation method is required to deal with open-loop recycling. Two different recycling allocation approaches were used in this study: 1) Closed-Loop Approximation combined with the Cut-Off Method, and 2) the ISO 14049 Number of Uses (NOU) method.

The first approach (Closed-Loop Approximation w/Cut-Off Method) was used to characterize the environmental loads of the industry-average product. Using this approach, it was assumed that the entire requirement for recovered fiber in containerboard production was fulfilled from converting wastes and old corrugated containers recovered at their end-of-life (i.e., closed-loop recycling). In other words, no other recovered fiber sources (e.g., mixed papers) were considered for allocation purposes and hence no environmental load from other product systems was brought within the system boundary. In doing so, there was a net export of recovered fiber to other systems because more old corrugated containers are recovered than the containerboard production process actually needs. It was assumed that this net export of recovered fiber leaves the system boundary without an environmental load associated with it (i.e., a cut-off method was used and all the environmental load is considered within the system).

The choice of an allocation approach for recycling can be critical for comparing paper products with different recycled fiber contents (e.g., Galeano et al. 2011, National Council for Air and Stream Improvement 2012). For this reason, two different approaches were used to express the environmental load of the 100%-recycled content product relative to that of the industry-average recycled content product, each of which provides a different perspective on how the environmental load of virgin production processes is shared between all usages of the fiber (i.e., virgin and recycled). The first approach used was the Closed-Loop Approximation with Cut-Off Method described above. The second approach employed was the Number of Uses (NOU) Method described in the ISO 14044 Standard and its accompanying Technical Report (ISO 14049). This second approach was selected for several reasons. Among them is a recommendation from an international working group addressing life cycle inventory issues, as included in a 1996 report by AF&PA (Life Cycle Inventory Analysis User's Guide - Enhanced Methods and Applications for the Products Industry), that this method be used in LCA studies of paper because it is the only one that reflects the complex interactions between virgin and recycled fiber. The main difference between the two methods is that the Cut-Off Method assigns the environmental loads and benefits from virgin material production to the products made of

virgin fiber only, while the Number of Uses method shares the loads and benefits between the product made of virgin fiber and those made of recycled fiber.

The life cycle modeling was done using the GaBi™ software package. Environmental impacts were characterized using the TRACI impact assessment method developed by U.S. EPA, using the Intergovernmental Panel on Climate Change (IPCC) AR5 factors for global warming. In accordance with accepted greenhouse gas accounting practices, biomass-derived CO₂ was tracked separately from fossil fuel-derived CO₂ and other greenhouse gases in the life-cycle inventory. The effects of biomass carbon on the atmosphere were characterized by calculating the net emissions of biogenic CO₂ (emissions minus removals), which were then added to the global warming results. This approach, referred to as flow accounting, was also used in the previous LCA study. In addition, impact indicator results were developed for the following indicators: ozone depletion, photochemical oxidation (smog), acidification, eutrophication, and fossil fuel depletion. Impacts on land use and biodiversity were not quantified as there is no consensus method suitable for forest management. The CML 2001 impact assessment method developed in the Netherlands was used to test the sensitivity of the acidification, eutrophication and smog indicators. Results were also developed for the following additional inventory indicators: non-renewable primary energy demand and renewable primary energy demand based on the method available in GaBi™, as well as water use and water consumption based on life cycle inventory data. Renewable primary energy demand excluded the intrinsic feedstock energy (heat of combustion) of any raw material input that is not used as an energy source in the studied product systems.

Sensitivity analyses were performed on various aspects.

ES.4 Results

This section summarizes the results obtained from this LCA.

ES.4.1 2014 Results: LCIA Profile

The cradle-to-grave life cycle impact assessment (LCIA) results obtained by applying TRACI, the IPCC factors for global warming, and GaBi non-renewable and renewable primary energy demands are shown in Table 1.

The results show that pulp and papermaking operations (primarily containerboard production) are the main contributor to all impact categories except global warming and water consumption. More detail on the global warming indicator is provided in the next section. Pulp and papermaking and converting contribute significantly to water consumption results. Converting is also a significant contributor to most other indicators. End-of-life contributes significantly to the global warming indicator results, but only when the flow approach is used for biogenic carbon accounting. Finally, the use phase (which primarily reflects the impacts of transportation) does not contribute significantly to impact categories.

Table 1. LCIA Results per Functional Unit

Impact category	Unit/FU	Total	Life Cycle Stage Contribution			
			1. Pulp and Papermaking Operations	2. Converting	3. Use	4. EoL
Impact Assessment Indicators						
Global warming, flow accounting*	kg CO ₂ eq.	0.533	3.6%	43.0%	5.5%	47.9%
Ozone depletion	kg CFC-11 eq.	6.89E-08	90.3%	8.9%	0.7%	0.1%
Photo-chemical oxidation (smog)	kg O ₃ eq.	0.122	76.5%	17.7%	4.8%	0.9%
Acidification	kg SO ₂ eq.†	1.19E-2	78.9%	17.5%	1.5%	2.0%
Eutrophication	kg N eq.†	9.46E-4	81.4%	12.0%	1.2%	5.3%
Respiratory effects (particulates)	kg PM2.5 eq.	1.23E-3	87.2%	10.9%	0.6%	1.3%
Fossil fuel depletion	MJ surplus	1.73	68.7%	27.4%	3.1%	0.7%
Additional Inventory Indicators						
Non-renewable energy demand	MJ	18.5	72.9%	24.4%	2.1%	0.6%
Renewable energy demand‡	MJ	9.6	92.8%	7.1%	0.0%	0.0%
Water use	kg	41.9	82.3%	17.3%	0.0%	0.4%
Water consumption	kg	13.1	47.4%	51.8%	0.0%	0.7%

NOTE: Percentages not adding up to 100% is due to rounding. *The flow accounting approach was also used in the previous LCA studies. †Total of air and water. ‡Excluding feedstock energy.

ES.4.2 2014 Results: Details on Global Warming

This section presents more details on the global warming indicator. Figure 2 presents how each life cycle stage contributes to individual GHGs. From this figure, the following can be observed:

- Pulp and papermaking is the greatest contributor to all GHGs and removals.
- Removals (primarily due to biomass grown to produce containerboard) offset a large proportion of all GHGs (biogenic CO₂ and other GHGs).
- Emissions of biogenic CO₂ occur mainly at pulp and paper mills.
- Emissions of other GHGs are spread out across pulp and papermaking operations, converting and end-of-life stages.
- Overall, the main contributors to the total global warming indicator are converting and end-of-life.

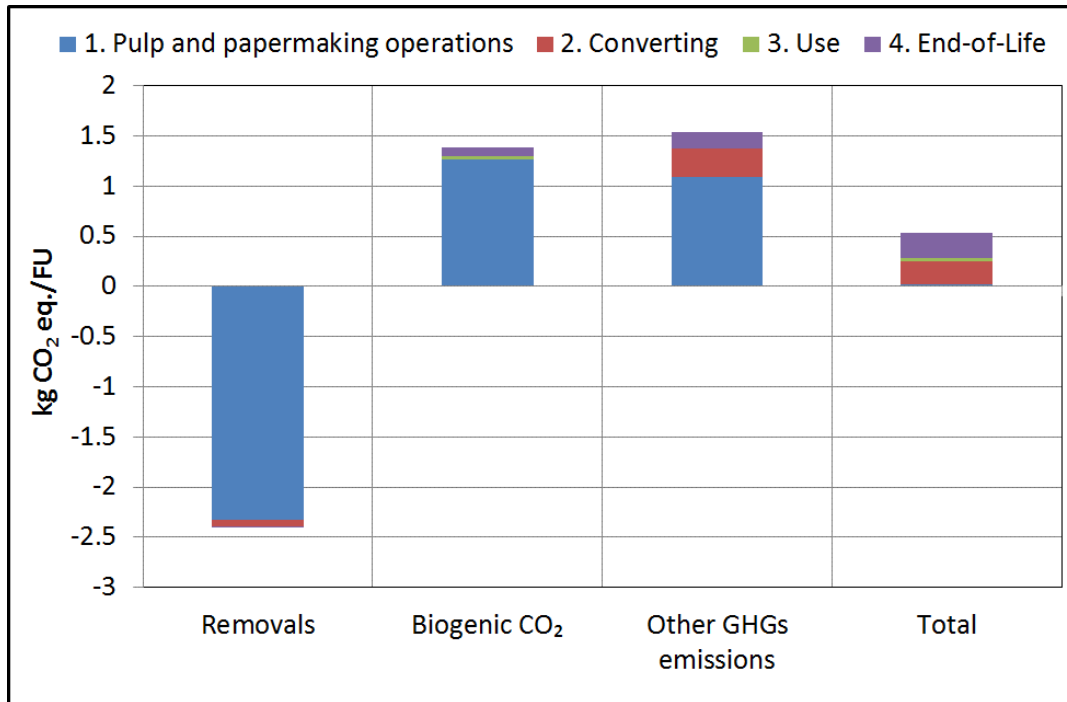

Figure 2. Contribution of the Life Cycle Stages to GHGs

Within the pulp and papermaking operations life cycle stage, forest operations are responsible for removals while energy production is the main process responsible for biogenic CO₂ and other GHG emissions. The rest, for instance chemical production and residuals management, does not contribute significantly to the global warming indicator.

On the converting side, while some removals are associated with chemical (starch) usage, there are very few emissions of biogenic CO₂ because converting facilities do not typically use biomass fuels. A fraction of the biogenic carbon associated with starch is released at the end of life. Other GHGs are distributed across energy (primarily purchased electricity and natural gas), transportation of the containerboard to converting facilities, and chemicals (primarily starch and ink).

At end-of-life, methane from landfills is the main contributor to the global warming indicator. The previous study showed that results for the global warming indicator were sensitive to assumptions regarding landfill gas recovery and burning. The sensitivity analysis was not repeated in this study but the effect is expected to be somewhat less important than in previous studies because less corrugated product was landfilled in 2014 than in 2010.

ES.4.3 2014 Results: Sensitivity Analyses

Sensitivity analyses were performed on various aspects. Some observations from these are as follows.

- As illustrated in Figure 3, the global warming indicator results are sensitive to the approach used to calculate emissions of biogenic CO₂.
- The global warming indicator results are also somewhat affected by the board mix (i.e., ratio of 100%-recycled linerboard, all other linerboard, 100%-recycled medium and all other medium), the quantity of energy used at converting facilities and the recovery rate.
- Somewhat different results are obtained when using the CML and TRACI methods for the eutrophication indicator, mainly because these two methods give priority to different substances released to the environment.

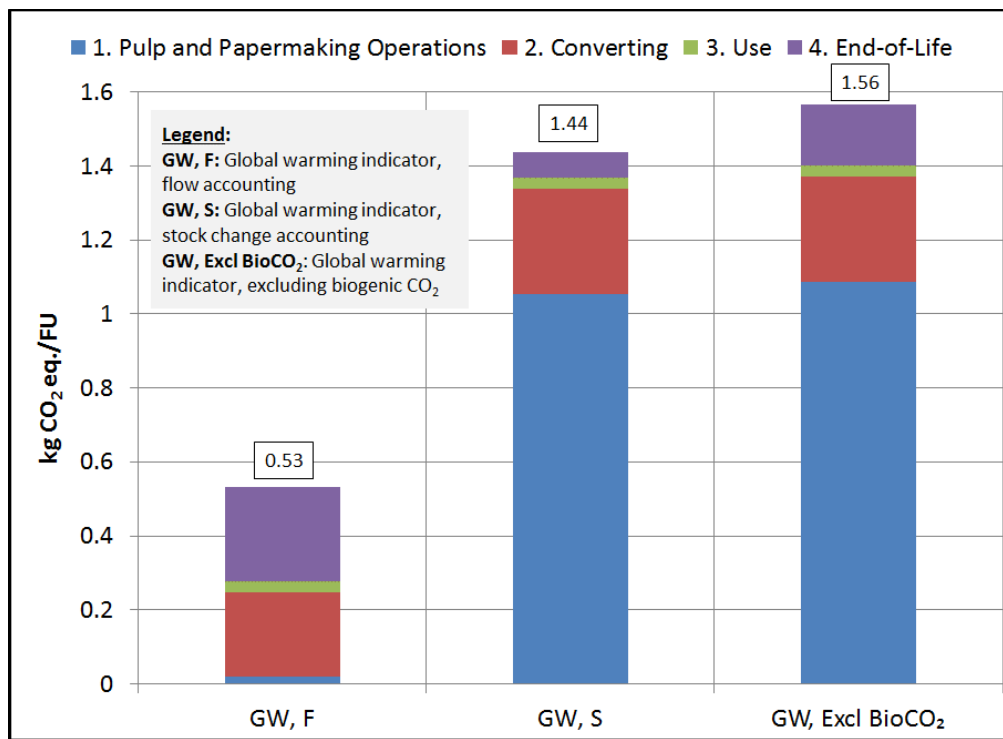

Figure 3. Effect of the Selection of the Indicator on the Observed Global Warming Results

ES.4.4 2014 vs. 2010 Results

One objective of this study was to compare the corrugated life cycle environmental performance in 2014 to that in 2010 and 2006 to document any changes. Table 2 presents an overview of the factors with an effect on the year-to-year comparison.²

² The results published in this report for 2006 and 2010 vary slightly compared to these published in the 2014 report, although the general findings remain unchanged. There are a few reasons for this. First, a calculation error affecting slightly the board mix was found in the original study for 2010 were corrected in this version. Second, some of the

Table 2. Main Drivers for Change in Environmental Performance between 2006, 2010 and 2014

Model parameter	2006	2010	2014	Expected effect on the results
Recovery rate	72%	85%	89.5%	Increasing the recovery rate decreases the quantity of product going to landfill within the system boundaries with the primary effect of reducing GHG releases.
Utilization rate of recovered fiber (kg/kg CBD)	0.42*	0.46*	0.52*	The main anticipated effects of increasing the percent board from recycled fiber, and more specifically increasing the utilization rate, are to reduce the quantity of carbon removal in the system (sequestration), to reduce total energy use at containerboard mills (and more specifically energy from renewable sources) and to reduce water use.
Board from 100%-recycled fibers	22.3%	26.6%	30.5%	
Carbon removal (kg CO ₂ eq./kg CP)	-2.8	-2.6	-2.4	Higher carbon removal reduces the total reported global warming results.
Total fossil fuels used at containerboard mills (MJ HHV/kg CP)	23.8	23.4	22.1	Less energy means lower emissions of GHGs and other air releases.
Share of natural gas in containerboard fossil fuels mix excluding purchased energy	46%	54%	73%	More natural gas in the fuel mix generally results in lower releases of several air pollutants. However, natural gas contributes more towards the fossil fuel depletion indicator (MJ surplus) than other fossil fuels because it is harder to extract.
Total energy used at converting (MJ/kg CP)	2.1	1.9	1.9	Less total energy means lower emissions of GHGs and other air releases. It also means lower total non-renewable energy demand.
Natural gas used at converting (MJ HHV/kg CP)	0.82	1.03	1.09	More natural gas in the fuel mix generally results in lower releases of several air pollutants. However, natural gas contributes more towards the fossil fuel depletion indicator (MJ surplus) than other fossil fuels because it is harder to extract.

NOTE: CBD is for containerboard and CP is for corrugated product.

*Numbers are different than reported by AF&PA. AF&PA numbers include containerboard that is exported. These numbers have been corrected to exclude the exports.

Figure 4 compares the impact scores obtained for 2014 with those obtained for 2010 and 2006. Changes by less than 10% are not considered meaningful (Franklin Associates 2004). From 2010 to 2014 the environmental performance generally remained stable, with most of the environmental improvements occurring between 2006 and 2010. More details regarding the different indicators are provided below.

data source and impact assessment methodologies were updated. Third, data collection for chemical usage at containerboard mills was streamlined. As a consequence, the 2006 and 2010 datasets were recalculated.

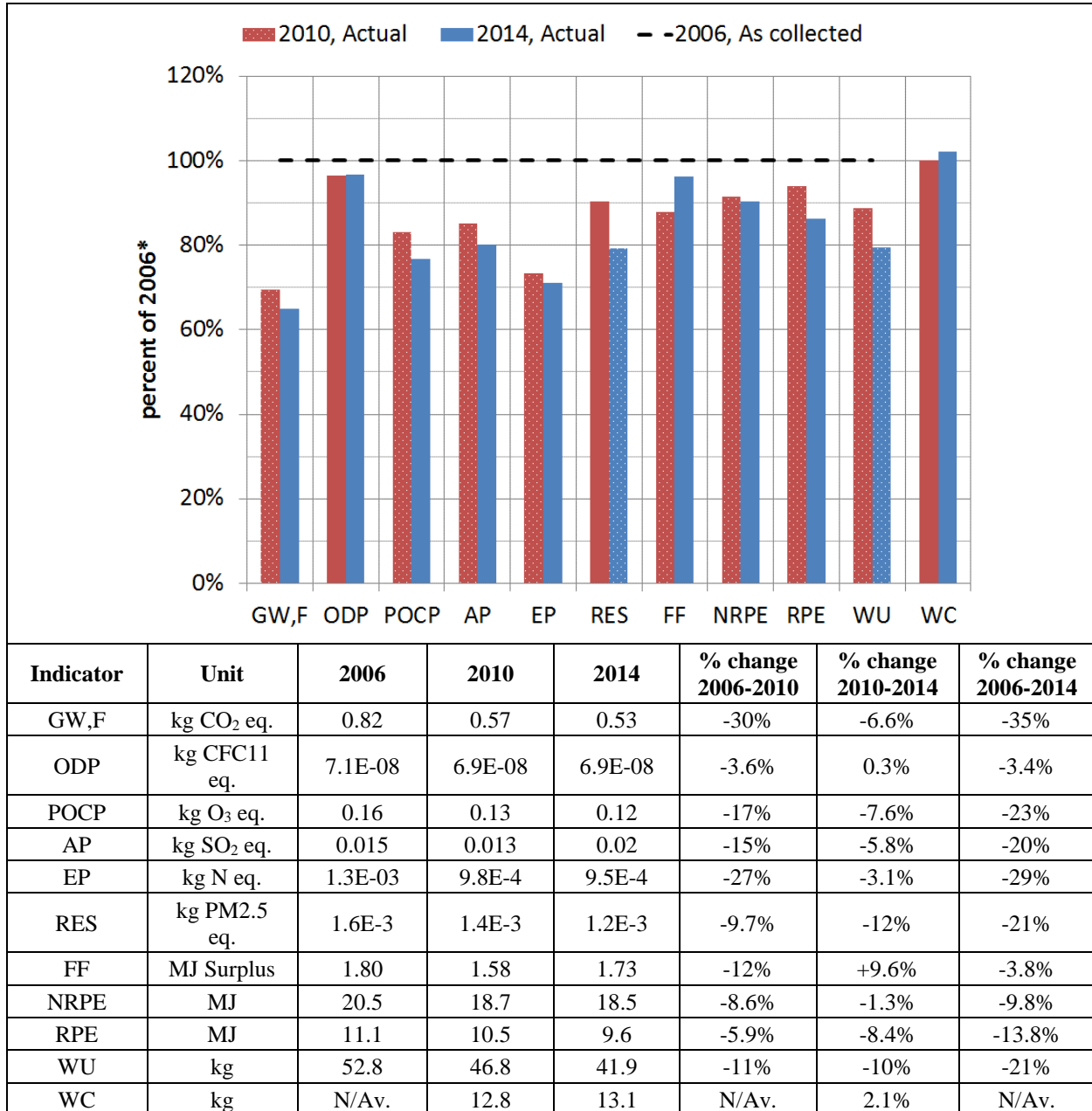

Figure 4. Comparing the Life Cycle Environmental Performance in 2014, 2010 and 2006 (In this figure, the bars with white dots indicate environmental indicators for which the score varied by 10% or more from the previous year. *Except for water consumption for which the reference year is 2010.)

The respiratory effects (particulates) indicator result was reduced by 12% between 2010 and 2014 mainly due to reduction of emissions of SO₂ and particulates from containerboard mills, primarily due to more natural gas in the fuel mix and less combustion of other fossil fuels.

There was a 10% reduction in water use between 2010 and 2014. The reduction in water use occurred mainly in the pulp and papermaking operations life cycle stage. There are two principal sources of water use reduction: water reduction in containerboard mills and, more importantly, a

greater share of 100%-recycled products in the board mix. Water consumption remained relatively stable.

Between 2010 and 2014, the global warming indicator (flow accounting; GW,F) result decreased by 6.6%, a change that is not considered meaningful³. Figure 5 provides insight into the different parameters that affected the difference between the two years.

GHGs were reduced in some respects:

- The recovery rate in 2014 was higher than in 2010, resulting in less corrugated containers sent to landfills and in turn decreased methane emissions.
- In 2014, the utilization rate was higher than in 2010, reducing total energy consumption and corresponding direct and indirect releases of GHGs. In addition, the share of fossil fuels from natural gas increased from 2010 to 2014, further reducing GHG emissions.

GHGs were increased in some other respects:

- The higher utilization rate in 2014 corresponds to reduced wood consumption, and hence less carbon removal through sequestration.
- Converting shows a modest increase in GHG releases due to an increased usage of additives (other than starch) and the fact that more containerboard passed through sheet feeder plants, representing more transportation.

Two other global warming indicators were tested in sensitivity analyses: one that uses the stock change accounting method and one that ignores biogenic CO₂. Using these two indicators, emissions of GHGs were reduced by 4% and 6%, respectively. More information concerning the different global warming indicators can be found in Section 5.2.

³ Any change of less than 10% in environmental indicator results is not considered meaningful.

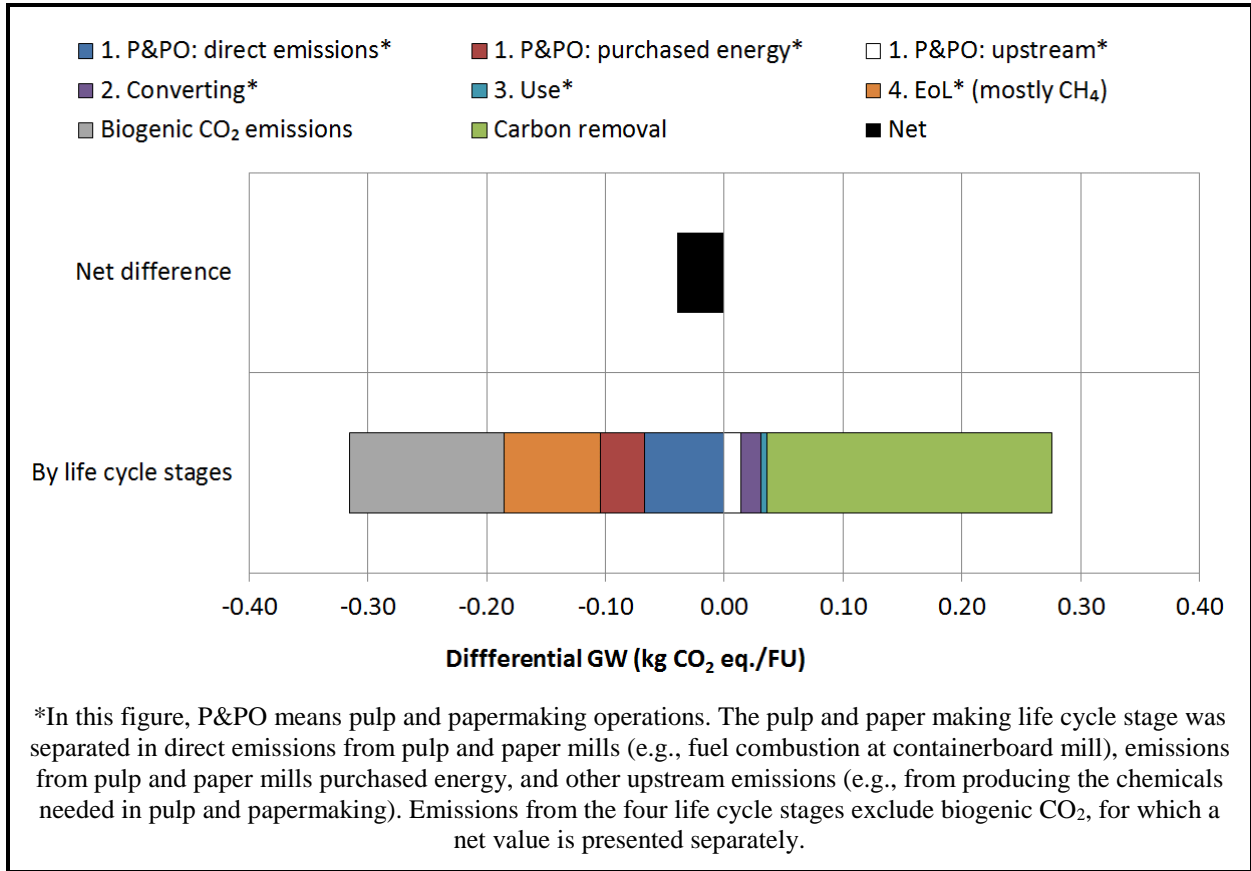

Figure 5. Factors Contributing to Difference in GHG Emissions between 2010 and 2014

Between 2010 and 2014, the impact score for fossil fuel depletion was increased by 9.6%, which is not considered to be meaningful. The main driver for this is increased consumption of natural gas in the life cycle of the product. Total non-renewable energy remained approximately stable. Total renewable energy decreased by 8%, mostly due to an increase in the share of 100%-recycled products in the board mix.

There was no meaningful change in the ozone depletion, smog, acidification and eutrophication indicators.

Sensitivity analyses showed that results of the comparison were generally robust. However, the global warming indicator results are sensitive to the relative contribution of the different board types in the industry-average board mix.

ES.4.5 100%-Recycled vs. Industry-Average

The environmental performance of the 100%-recycled content product relative to that of the industry-average recycled content product was derived using two allocation methods for recycling: the number of uses (NOU) method and the closed-loop approximation with cut-off (cut-off) method. Table 3 presents the main drivers for difference in environmental performance between the two products.

Table 3. Main Drivers for Difference in Environmental Performance between the Industry-Average and 100%-Recycled Products

Model parameter	2014 Industry-Average	2014 100%-Recycled	Expected effect on the results
Utilization rate of recovered fiber (kg/kg CBD)	0.52*	1.23	The main anticipated effects of increasing the percent board from recycled fiber, and more specifically increasing the utilization rate, are to reduce the quantity of carbon removal in the system (sequestration), to reduce total energy use at containerboard mills (more specifically, energy from renewable sources), and to reduce water use.
Carbon removal (kg CO ₂ eq./kg CP)	-2.4	-0.2	Higher carbon removal reduces the total reported global warming results.
Total fossil fuels used at containerboard mills (MJ HHV/kg CP)	22.1	9.70	Less fossil fuels means lower emissions of GHGs and other air releases. It also means lower total non-renewable energy demand.
Total biomass fuels	13.9	0.64	Biomass fuels produce greater air emissions than natural gas.
Net virgin production load transfer (applicable only to the NOU method)	26% †	≈15% ‡	Exporting/importing virgin environmental load means exporting/importing environmental impacts (e.g., related to energy production) and benefits (e.g., carbon removal) of producing virgin material.

NOTES: Unless otherwise specified, numbers presented in the table do not account for virgin production load transfer applied with the NOU method. CBD is for containerboard and CP is for corrugated product.

*Number is different than reported by AF&PA. AF&PA numbers includes exports while this number was corrected to account for only domestic use of containerboard. †Meaning that, when accounting for the net generation/use of recovered fiber, 26% of the environmental load from producing virgin fibers in the industry-average is exported to subsequent uses of the fiber. ‡Meaning that, for each kg of recovered fiber (mainly OCC) used in the 100%-recycled product, the environmental load equivalent of producing 0.15 kg of virgin fibers is imported within the system boundaries.

Number of Uses (NOU) Method

The environmental indicator results of the 100%-recycled product relative to that of the industry-average product obtained using the Number of Uses method are presented in Figure 6. The following observations can be made from this figure:

- Using the NOU method, the industry-average product results in lower environmental impact scores for the global warming, smog, acidification, respiratory effects (particulates), fossil fuel depletion, non-renewable energy demand and water consumption indicators.
- Using the NOU method, the 100%-recycled product results in lower environmental impact scores for the renewable energy demand and water use indicators.
- Using the NOU method, there is no significant difference between the industry-average and 100%-recycled products for the ozone depletion and eutrophication indicators.

Sensitivity analyses other than the allocation method for recycling were undertaken to test the robustness of the comparison results. The analyses indicated that the results are relatively robust.

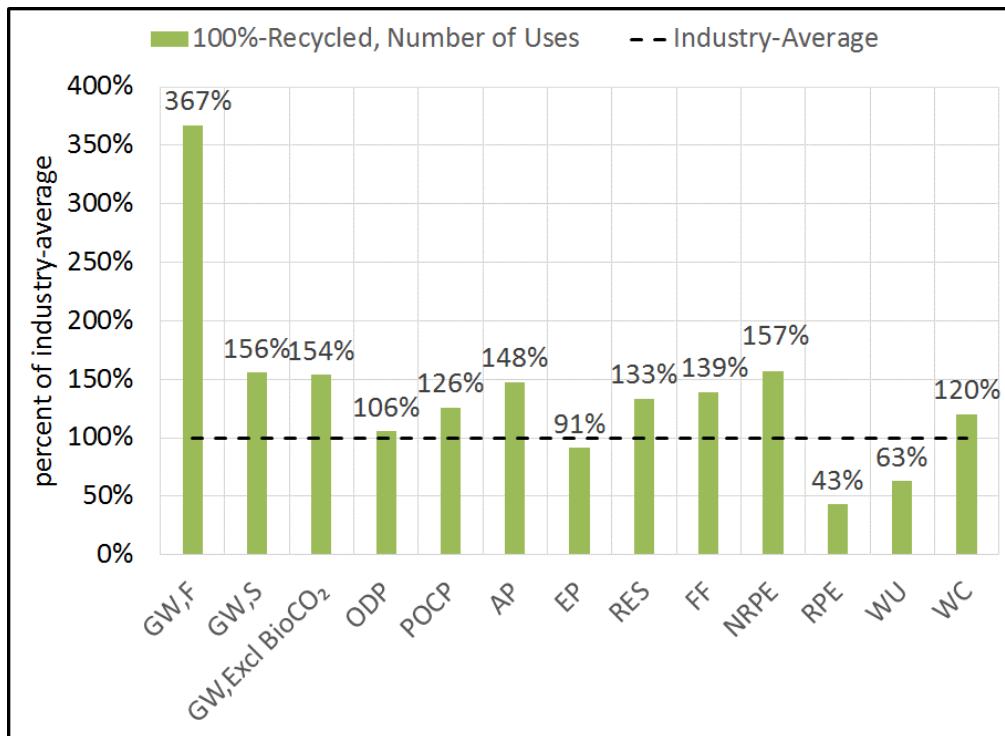

Figure 6. Impact Scores for the 100%-Recycled Product Relative to that of the Industry-Average Product (Number of Uses Method)

Closed-Loop Approximation with Cut-Off Method

The environmental indicator results of the 100%-recycled product relative to that of the industry-average product obtained using the closed-loop approximation with cut-off (cut-off) method are presented in Figure 7. The following observations can be made from this figure:

- Using the cut-off method, the industry-average product results in lower environmental impact scores for the global warming (flow accounting approach) indicator.
- Using the cut-off method, the 100%-recycled product results in lower environmental impact scores for the ozone depletion, smog, eutrophication, respiratory inorganic, renewable energy demand and water use indicators.
- Using the cut-off method, there is no significant difference between the industry-average and 100%-recycled products for the acidification, fossil fuel depletion, non-renewable energy demand and water consumption indicator.

Sensitivity analyses other than the allocation method for recycling were undertaken to test the robustness of the comparison results. The analyses indicated that the results are relatively robust. One exception is worth mentioning. The results for the global warming indicator are very sensitive to the selection of the accounting approach for biogenic CO₂. On one hand, the industry-average product performs significantly better than the 100%-recycled product when using the flow accounting approach. On the other hand, the difference is not significant when applying the stock change accounting method or when ignoring the emissions of biogenic CO₂.

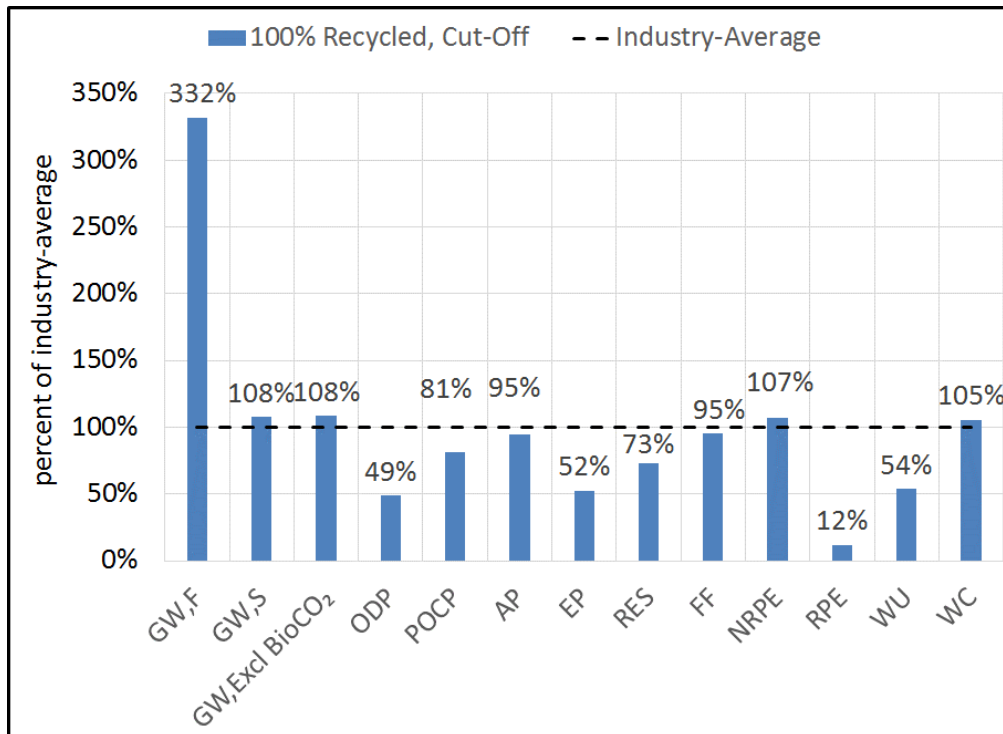

Figure 7. Impact Scores for the 100%-Recycled Product Relative to that of the Industry-Average Product (Closed-Loop Approximation w/ Cut-Off Method)

ES.5 Conclusions

This study represents a comprehensive LCA of the 2014 U.S. industry-average corrugated product. The main conclusions that can be drawn from the study include the following.

Pulp and papermaking production (containerboard) is the main driver of the life cycle environmental performance. For all impact categories, material and energy flows from paper mills dominate the results (positively or negatively). Environmental impacts are dominated by energy demands at the mill. Bio-based energy (e.g., hog-fuel, liquor, etc.) substantially reduces the global warming contribution from mills. Converting facilities also contribute relatively significantly to most impact categories.

End-of-Life is only significant with respect to the global warming indicator results. Other life-cycle impact indicators show little or no response from the end-of-life stage. The global warming potential observed at end-of-life is mainly due to methane released from landfill operations. Sensitivity analyses clearly showed that increasing the recovery rate has the potential to improve overall environmental performance.

The global warming indicator results are highly dependent on the accounting method for biogenic CO₂. Two different accounting approaches can be used to compute the results for the global warming indicator: flow accounting, which was the main method employed in this study, and stock accounting, which was examined in a sensitivity analysis. Flow accounting is the accounting method the most used in LCA studies. Stock change accounting is mostly used in national inventories. Another approach sometimes used in LCA is simply ignoring biogenic CO₂ when calculating the global warming indicator results to get an understanding of how non-biogenic CO₂ GHG contribute to the global warming indicator. Note that this approach ignores any removal/storage of biogenic carbon. The pulp and papermaking operations life cycle went from being an insignificant contributor to global warming when applying the flow accounting approach to a very significant contributor when applying the stock change method or ignoring biogenic CO₂. When applying the stock change accounting approach or ignoring biogenic CO₂, the contribution of end-of-life to the overall global warming results was reduced compared to when applying the flow accounting method.

Overall, the life cycle environmental performance was essentially stable between 2010 and 2014. However, significant improvements were observed for the respiratory effects (particulates) and water use indicators. The main drivers for the reduction in particulate release is the increase share of natural gas in the containerboard mills energy mix. The reduction in water use is mainly due to an increase in recycled content.

The results of comparisons of the industry average product to 100%-recycled product varied by indicator with some results being strongly dependent on the allocation method chosen for recycling. In summary, the industry-average indicator results were lower for the global warming, acidification and non-renewable energy indicators regardless of the allocation method used, although for the non-renewable indicator the results obtained with the cut-off allocation method showed that the difference between the two products was not significant. Results also suggest that the 100%-recycled product generates lower emissions of eutrophying substances and uses less water and renewable energy than the industry-average, although for the eutrophication

indicator the results obtained with the Number of Uses allocation method showed that the difference between the two products was not significant. The results for the other environmental indicators (i.e., ozone depletion, smog, eutrophication, respiratory effects, fossil fuel depletion) depend on the allocation method.



NATIONAL COUNCIL FOR AIR AND STREAM IMPROVEMENT

**2014 LIFE CYCLE ASSESSMENT OF
U.S. AVERAGE CORRUGATED PRODUCT**

Final Report

Prepared for

Corrugated Packaging Alliance (CPA)

A joint venture of

American Forest & Paper Association (AF&PA)

Fibre Box Association (FBA)

AICC, The Independent Packaging Association (AICC)

TAPPI

May 23, 2017

By

**NCASI
Cary, NC**

For information contact:

Caroline Gaudreault
NCASI
P.O. Box 1036, Station B
Montreal, QC, H3B 3K5
(514) 286-1182
cgaudreault@ncasi.org

Brad Upton
NCASI
227 NW Third Street,
Corvallis, OR 97333
(541) 368-7707
bupton@ncasi.org

National Council for Air and Stream Improvement, Inc. (NCASI). 2017. 2014 Life Cycle Assessment of U.S. Average Corrugated Product – **Final Report**. Report prepared for the Corrugated Product Alliance (CPA). Cary, N.C.: National Council for Air and Stream Improvement., Inc.

PROJECT INFORMATION

Project Title	2014 Life Cycle Assessment of U.S. Average Corrugated Product
Project Commissioner	Corrugated Packaging Alliance (CPA), a joint venture of the American Forest & Paper Association (AF&PA), Fibre Box Association (FBA), AICC, The Independent Packaging Association (AICC) and TAPPI 500 Park Blvd, Suite 985 Itasca, IL 60143
Client Contact	Brian O'Banion Fibre Box Association 500 Park Blvd, Suite 985 Itasca, IL 60143 bobanion@fibrebox.org
Disclaimer	The information contained in this report has been obtained or derived from sources believed to be reliable. However, the authors or their companies are not responsible and do not bear the costs arising from the use of this information. The use of this information is at the sole responsibility of CPA.
Report Version	Final Report, May 23, 2017
Project Team	Caroline Gaudreault, PhD (Program Manager, NCASI) Brad Upton, PhD (Principal Research Engineer, NCASI) Kirsten Vice (Vice President- Sustainable Manufacturing & Canadian Operations, NCASI)
Peer Reviewer	Lindita Bushi, Athena Institute

TABLE OF CONTENTS

LIST OF FIGURES	3
LIST OF TABLES	6
ACRONYMS AND ABBREVIATIONS.....	9
EXECUTIVE SUMMARY	13
1. INTRODUCTION	30
2. GOAL OF THE STUDY	32
3. SCOPE OF THE STUDY.....	33
3.1 Product under Study.....	33
3.2 Representativeness	36
3.3 Function, Functional Unit and Reference Flows	37
3.4 System Boundary	37
3.5 Allocation Procedures	41
3.6 Data Quality Requirements.....	47
3.7 Comparison between Systems	50
4. LIFE CYCLE INVENTORY.....	51
4.1 Data Collection Procedures, Main Data Sources and Validation	51
4.2 Detailed Description of the Product System and Related Unit Processes	58
4.3 Calculation Procedures	76
4.4 Data Quality Assessment	76
5. LIFE CYCLE IMPACT ASSESSMENT METHODS.....	79
5.1 General LCIA Methods.....	79
5.2 Accounting Practices for Biogenic Greenhouse Gases and Land Use Change	81
6. RESULTS AND INTERPRETATION: 2014 LCA	86
6.1 LCIA and Additional Indicator Results	86
6.2 Identification of Significant Issues	87
6.3 Sensitivity Analyses.....	98
7. RESULTS AND INTERPRETATION: YEAR-TO-YEAR COMPARISON.....	100

7.1 Comparison Results	100
7.2 Sensitivity Analyses.....	105
8. RESULTS AND INTERPRETATION: 100%-RECYCLED VS. INDUSTRY-AVERAGE	108
8.1 Number-of-Uses Method	108
8.2 Closed-Loop Approximation with Cut-Off Method.....	120
8.3 Summary.....	130
9. EVALUATION	132
9.1 Sensitivity Check	132
9.2 Completeness and Consistency Checks.....	132
9.3 Uncertainty Analysis.....	132
9.4 Data Quality Analysis.....	133
10. CONCLUSIONS	134
10.1 2014 Industry-Average	134
10.2 2014 vs. 2010.....	134
10.3 100%-Recycled vs. Industry-Average	135
11. CRITICAL REVIEW.....	136
APPENDICES.....	139
A. Discussion of ISO 14044 Options for Allocation.....	140
B. Carbon Content and Mass Balances	143
C. Comparing 2006, 2010 and 2014 Environmental Performances	152
D. Detailed Data Sources.....	153
E. Detailed Inventory Data - Average Containerboard.....	158
F. Modified Mass Allocation	161
G. Number of Uses Method.....	169
H. Impact Indicators	173
I. 2014 Industry-Average LCA Results by GHG Protocol Scopes	180
J. Toxicity Indicator Results.....	182
K. Detailed Peer Review Comments and Answers.....	183
L. List of References	193

LIST OF FIGURES

Figure 1.	System Boundary	15
Figure 2.	Contribution of the Life Cycle Stages to GHGs	19
Figure 3.	Effect of the Selection of the Indicator on the Observed Global Warming Results	20
Figure 4.	Comparing the Life Cycle Environmental Performance in 2014, 2010 and 2006	22
Figure 5.	Factors Contributing to Difference in GHG Emissions between 2010 and 2014.	24
Figure 6.	Impact Scores for the 100%-Recycled Product Relative to that of the Industry- Average Product (Number of Uses Method)	26
Figure 7.	Impact Scores for the 100%-Recycled Product Relative to that of the Industry- Average Product (Closed-Loop Approximation w/ Cut-Off Method)	27
Figure 8.	Various Structure of Corrugated Board	34
Figure 9.	System Boundary for the Corrugated Product System	38
Figure 10.	Schematic Illustration of Open-Loop Recycling Allocation Method Used in this Study a) Actual Product System, b) Product System Modeled for Open-Loop Recycling	45
Figure 11.	Data Collection Strategy for Background Processes	52
Figure 12.	Schematic of Pulp and Papermaking Operations Life Cycle Stage, 2014 Industry- Average	64
Figure 13.	Papermaking Process	69
Figure 14.	Overview of Converting Operations	71
Figure 15.	Illustration of Various Biogenic Carbon Accounting Methods	83
Figure 16.	Contribution Analyses for LCIA Indicators, TRACI and IPCC (Industry-Average)	87
Figure 17.	Contribution Analyses for LCI Indicators, GaBi and Inventory (Industry-Average)	88
Figure 18.	Contribution Analyses for LCIA Indicators, CML Method (Industry-Average) .	88
Figure 19.	Global Warming Results.....	89

Figure 20.	Detailed Contribution Analyses for the Global Warming Indicator a) Type of Gases b) Pulp and Papermaking Operations, c) Energy used at Pulp and Papermaking Operations, and d) Converting (Industry-Average)	92
Figure 21.	2014 LCA Sensitivity Analysis Results.....	98
Figure 22.	Comparison of 2014, 2010 and 2006 Impact Scores	100
Figure 23.	Explanation of the Difference in GHG Emissions between 2010 and 2014.....	102
Figure 24.	Yearly Comparison of Global Warming Results, Details of the Flow Accounting Method	103
Figure 25.	Effect of Biomass CO ₂ Accounting on Yearly Comparison.....	104
Figure 26.	Effect of Board Mix on Comparison with 2010	106
Figure 27.	Effect of Functional Unit Definition on Observed Environmental Performance	107
Figure 28.	Contribution Analyses for LCIA Indicators, TRACI and IPCC (100%-Recycled, NOU Method)	110
Figure 29.	Contribution Analyses for LCI Indicators (100%-Recycled, NOU Method)	110
Figure 30.	Contribution Analyses for LCIA Indicators, CML Method (100%-Recycled, NOU Method).....	111
Figure 31.	Impact Scores for the 100%-Recycled Product Relative to that of the Industry-Average Product (NOU Method).....	112
Figure 32.	Difference in GHG Emissions between the Industry-Average and 100%-Recycled Products (NOU Method).....	113
Figure 33.	Results for the 100%-Recycled Product Relative to that of the Industry-Average Product: TRACI vs. CML (NOU)	116
Figure 34.	Effect of Board Mix on the Comparison of 100%-Recycled and Industry-Average Products (NOU Method).....	118
Figure 35.	Effect of Electricity Mix on the Comparison of 100%-Recycled and Industry-Average Products (NOU Method)	119
Figure 36.	Sensitivity Analysis on the Potential Effect of Having 100%-Recycled Medium Under-Represented in the Collected Data (NOU Method).....	120
Figure 37.	Contribution Analyses for LCIA Indicators, TRACI and IPCC (100%-Recycled, Cut-Off Method)	122
Figure 38.	Contribution Analyses for LCI Indicators (100%-Recycled, Cut-Off Method) .	123

Figure 39.	Contribution Analyses for LCIA Indicators, CML Method (100%-Recycled, Cut-Off Method)	123
Figure 40.	Impact Scores for the 100%-Recycled Product Relative to that of the Industry-Average Product (Cut-Off Method).....	124
Figure 41.	Difference in GHG Emissions between the Industry-Average and 100%-Recycled Corrugated Products (Cut-Off Method).....	125
Figure 42.	Results for the 100%-Recycled Product Relative to that of the Industry-Average Product: TRACI vs. CML (Cut-Off)	127
Figure 43.	Effect of Board Mix on the Comparison of 100%-Recycled and Industry-Average Products (Cut-Off Method).....	128
Figure 44.	Effect of Electricity Mix on the Comparison of 100%-Recycled and Industry-Average Products (Cut-Off Method)	129
Figure 45.	Sensitivity Analysis on the Potential Effect of Having 100%-Recycled Medium Under-Represented in the Collected Data (Cut-Off Method).....	130
Figure 46.	Carbon Balance on Converting Operations (2014 Industry-Average)	144
Figure 47.	Cradle-to-Grave Carbon Balance: Industry-Average Product	150
Figure 48.	Cradle-to-Grave Biogenic Carbon Balance: 100%-Recycled Product	151
Figure 49.	Stepwise Procedure for Applying the Number-of-Uses Allocation Procedure to Pulp and Paper Products	169
Figure 50.	Uses of Recovered OCC: Open-Loop Recycling	170
Figure 51.	Greenhouse Effect.....	173
Figure 52.	Ozone Depletion Impact Pathways	174
Figure 53.	Acidification Impact Pathways	175
Figure 54.	Eutrophication Impact Pathways	175
Figure 55.	Photo-Chemical Oxidant Formation Impact Pathways.....	176
Figure 56.	Connection of the Forest Products Industry to the Water Cycle	178
Figure 57.	GHG Emissions by Scopes of the GHG Protocol.....	181

LIST OF TABLES

Table 1.	LCIA Results per Functional Unit	18
Table 2.	Main Drivers for Change in Environmental Performance between 2006, 2010 and 2014.....	21
Table 3.	Main Drivers for Difference in Environmental Performance between the Industry-Average and 100%-Recycled Products.....	25
Table 4.	Mix of Boards in 2014 U.S.-Average Containerboard	33
Table 5.	Mix of Boards in U.S.-Average Containerboard (2006, 2010 and 2014).....	35
Table 6.	Mix of Boards in U.S.-Average Containerboard	36
Table 7.	Estimated Technology Representativeness of Containerboard Mills and Converting Plants (2014)	36
Table 8.	Summary of Boundary Conditions	40
Table 9.	Proposed Allocation Hierarchy for Fuels	43
Table 10.	Comparison of the Cut-Off and Number of Uses Methods	46
Table 11.	Data Quality Requirements.....	48
Table 12.	Primary Data Sources	53
Table 13.	Heating Values of Fuels for the 2014 Dataset	54
Table 14.	Carbon Contents of Various Materials	55
Table 15.	Woody Material Inputs per Functional Unit.....	59
Table 16.	Types of Recovered Paper Used in Containerboard Production (2014).....	61
Table 17.	Electricity Mix for Industry-Average and 100%-Recycled Containerboard	62
Table 18.	U.S. Average Electricity Grid Fuel Consumption Mix.....	63
Table 19.	Inputs/Outputs to Containerboard Production Unit Process per Functional Unit.	65
Table 20.	Inputs/Outputs to Converting Unit Processes per Functional Unit (1.0 kg Corrugated Product).....	71
Table 21.	Parameters for Calculating Carbon Emissions from Landfilling of OCC	74

Table 22.	Details of Transportation Modeling Assumptions	75
Table 23.	Data Quality Assessment	77
Table 24.	Selected Methods for LCA Impact Categories	80
Table 25.	Evaluation of International Acceptance of the Category Indicators Used.....	81
Table 26.	LCIA Indicator Results per Functional Unit (Industry-Average).....	86
Table 27.	LCI Indicator Results per Functional Unit (Industry-Average).....	86
Table 28.	Contribution of the Various Life Cycle Stages/Groups of Unit Processes to the Global Warming Results by Type of Gases (Industry-Average).....	91
Table 29.	Contribution of the Various Life Cycle Stages/Groups of Unit Processes to the Ozone Depletion Results by Substances (Industry-Average).....	93
Table 30.	Contribution of the Various Life Cycle Stages/Groups of Unit Processes to the Smog Results by Substances, TRACI Method (Industry-Average)	94
Table 31.	Contribution of the Various Life Cycle Stages/Groups of Unit Processes to the Acidification Results by Substances, TRACI Method (Industry-Average).....	94
Table 32.	Contribution of the Various Life Cycle Stages/Groups of Unit Processes to the Eutrophication Results by Substances, TRACI Method (Industry-Average).....	95
Table 33.	Contribution of the Various Life Cycle Stages/Groups of Unit Processes to the Respiratory Effects Results by Substances, TRACI Method (Industry-Average) 96	
Table 34.	Contribution of the Various Life Cycle Stages/Groups of Unit Processes to the Fossil Fuel Depletion Results by Fuels, TRACI Method (Industry-Average)	97
Table 35.	Contribution of the Various Life Cycle Stages/Groups of Unit Processes to the Non-Renewable Primary Energy Results by Fuels, GaBi Method (Industry-Average).....	97
Table 36.	Sensitivity Analysis on Board Mix	99
Table 37.	Basis Weight Sensitivity Analysis Settings	107
Table 38.	LCIA Indicator Results per Functional Unit (100%-Recycled, NOU Method) .	109
Table 39.	LCI Indicator Results per Functional Unit (100%-Recycled, NOU Method)	109
Table 40.	Mix of Boards in Corrugated Products	117
Table 41.	LCIA Indicator Results per Functional Unit (100%-Recycled, Cut-Off Method)	121

Table 42.	LCI Indicator Results per Functional Unit (100%-Recycled, Cut-Off Method)	121
Table 43.	Environmental Indicator Results for the 100%-Recycled Product Relative to that of the Industry-Average Product Given Two Allocation Methods for Recycling	131
Table 44.	Fiber Balance for the 2014 Industry-Average Containerboard Production	145
Table 45.	Carbon Balance for the 2014 Industry-Average Containerboard Production.....	146
Table 46.	Fiber Balance for the 100%-Recycled Containerboard Production.....	147
Table 47.	Carbon Balance for the 2014 100%-Recycled Containerboard Production	148
Table 48.	Mix of Boards in U.S.-Average Containerboard (2006, 2010 and 2014).....	152
Table 49.	List of Datasets Used in the Study	153
Table 50.	Detailed Containerboard LCI Data (per 1 odst of Containerboard)	158
Table 51.	Example Mill Producing Multiple Products from Multiple Furnishes	162
Table 52.	Example Mill Simple Mass Allocation of BOD ₅	162
Table 53.	Example Mill Products and Furnishes	163
Table 54.	NCASI Production Categories	163
Table 55.	Example Mill BOD ₅ Allocations Incorporating Process Knowledge.....	166
Table 56.	Example Mill Mass Allocation of BOD ₅ with and without Incorporation of Process Knowledge.....	167
Table 57.	Data for Calculating the Number of Uses of OCC	171
Table 58.	Contributors to the Human Health Non-Cancer Impact Category (HHNC).....	182
Table 59.	Contributors to the Human Health Cancer Impact Category (HHC).....	182
Table 60.	Contributors to the Ecotoxicity (ECO) Impact Category	182

ACRONYMS AND ABBREVIATIONS

Organizations:

AF&PA:	American Forest & Paper Association
AICC:	AICC, The Independent Packaging Association
CORRIM:	Consortium for Research on Renewable Industrial Materials
CML:	Centre of Environmental Science at Leiden
CPA:	Corrugated Packaging Alliance
FBA:	Fibre Box Association
ISO:	International Organization for Standardization
NCASI:	National Council for Air and Stream Improvement
NREL:	National Renewable Energy Laboratory
PE:	PE Americas
U.S. EPA:	United States. Environmental Protection Agency
WBCSD:	World Business Council for Sustainable Development
WRI:	World Resources Institute

General:

AOX:	Adsorbable organic halides
BCTMP:	Bleached chemi-thermomechanical pulp
BK:	Bleached kraft
BKD:	Bleached kraft dissolving
BKI:	Bleached kraft, integrated
BKMP:	Bleached kraft market pulp
BKO:	Bleached kraft, other
BOD:	Biochemical oxygen demand
CFCs:	Chlorofluorocarbons
CFS:	Commodity Flow Survey
CHP:	Combined heat and power
CP:	Corrugated product
COD:	Chemical oxygen demand
DTF:	Deinked tissue/fine papers

EH&S:	Environment, Health and Safety
EI:	ecoinvent
EoL:	End-of-life
eq.:	Equivalent
FU:	Functional unit
GHG:	Greenhouse gas
GWP:	Global warming potential
HFCs:	Hydrofluorocarbons
HGD:	High-grade deinking
HHV:	Higher heating value
HWD:	Hardwood
IUR:	Inventory Update Reporting (U.S. EPA)
LCA:	Life cycle assessment
LCI:	Life cycle inventory
LCIA:	Life cycle impact assessment
LHV:	Lower heating value
MECH:	Mechanical
NIF:	Non-integrated fine or lightweight papers
NOU:	Number of Uses
OCC:	Old corrugated containers
odst:	Oven-dried short ton
P&P:	Pulp and paper
P&PO:	Pulp and papermaking operations
PM:	Particulate matter
PWM:	Production-weighted mean
PS:	Pulp substitutes
RBOX:	Recycled boxboard
RCTR:	Recycled containerboard
RNDI:	Recycled non-deinked
RTF:	Recycled tissue/Fine paper
SC:	Semi-chemical

SCTG:	Standard Classification of Transported Goods
SULD:	Sulfite dissolving pulp
SULF:	Sulfite paper grade
SWD:	Softwood
ton:	Short ton
TRACI:	Tool for the Reduction and Assessment of Chemical and Other Environmental Impacts
TRI:	Toxic Release Inventory (U.S. EPA)
TRS:	Total reduced sulfur
TSS:	Total suspended solids
UBKMP:	Unbleached kraft market pulp
UK:	Unbleached kraft
VOC:	Volatile organic compound
WWTP:	Wastewater treatment plant

Country/Region Codes used in Datasets:

BE:	Belgium
CH:	Switzerland
DE:	Germany
EU-27:	European Union, not including Croatia
FR:	France
GLO:	Global
NC:	U.S. Northcentral
NE:	U.S. Northeast
NL:	Netherlands
PNW:	U.S. Pacific Northwest
RNA:	North America
SE:	U.S. Southeast
US:	United States

Impact Categories and Other Indicators:

AP:	Acidification
ECO:	Ecotoxicity

EP:	Eutrophication
FF:	Abiotic resource depletion, fossil fuel
GW:	Global warming, F: flow accounting, S: stock accounting, Excl. BioCO ₂ : excluding biogenic CO ₂
HHC:	Human health cancer
HHNC:	Human health non-cancer
NRPE:	Non-renewable primary energy demand
ODP:	Ozone depletion
POCP:	Photo-chemical oxidation/Photo-chemical ozone creation
RES:	Respiratory effects
RPE:	Renewable primary energy demand
WC:	Water consumption
WU:	Water use (Water withdrawal in ISO 14046 (2014))

EXECUTIVE SUMMARY

ES.1 Background and Objective

The Corrugated Packaging Alliance (CPA), a joint venture of the American Forest & Paper Association (AF&PA), Fibre Box Association (FBA), AICC, The Independent Packaging Association (AICC) and TAPPI, have commissioned NCASI to conduct a life cycle assessment (LCA) study of the 2014 U.S.-average corrugated product. There were three main objectives to the study:

- 1) To educate customers and stakeholders about the environmental attributes of the industry's corrugated packaging produced in 2014;
- 2) To contrast, to the extent possible, the updated results with those of 2006 and 2010; and
- 3) To present the environmental performance of a corrugated product made of 100%-recycled fiber relative to that of the industry average recycled content.

This study was performed following the principles described in the ISO 14040/14044 standards for a publicly disclosed study.

The study being an update of the 2010 LCA published in 2014, it was reviewed by one external reviewer instead of a panel. The reviewer was Lindita Bushi from Athena Institute. The critical review in no way implies that the reviewer endorses the results of the LCA study, nor that they endorse the assessed products. It ensures that the study, among other requirements, was carried out per the provisions of the ISO standards.

ES.2 Products Studied

Four different products manufactured and used in the U.S. were studied in this assessment:

1. The 2014 U.S. industry-average corrugated product (main product studied in this LCA);
2. The 2010 U.S. industry-average corrugated product;
3. The 2006 U.S. industry-average corrugated product; and
4. The 2014 U.S. industry-average corrugated product made from 100%-recycled fiber (often referred to in this study as the 100%-recycled product).

Corrugated products (for instance corrugated boxes) are made of corrugated board (combined board). Corrugated board is the structure formed by bonding one or more sheets of fluted corrugating medium to one or more flat facings of linerboard.

The 2014 U.S.-average corrugated product studied in this LCA consists of 66.8% linerboard and 33.2% corrugated medium with an average basis weight of 131.6 lb/thousand square feet (msf, 0.643 kg/m²). The industry-average containerboard utilizes about 52%¹ recovered fiber, primarily old corrugated containers (OCC), with the balance supplied mostly by kraft and semi-chemical pulp. More information regarding the 2010 and 2006 product can be found in the LCA reports from prior assessments (<http://www.corrugated.org/ViewPage.aspx?ContentID=36> and (<http://www.corrugated.org/upload/CPALCAfinalreport08-25-10.pdf>, respectively). ISO 14044 requires that whenever two products are compared, these should be functionally equivalent. For that reason, the 100%-recycled product studied in this study and compared to the industry-average was modeled using the same board mix (linerboard to medium ratio). It was also assumed that the 100%-recycled product had the same basis weight as the industry-average product.

ES.3 The Study Design and Methods Employed

The functional unit for the study was *"the domestic use of 1 kg of an average corrugated product produced in the U.S. in 2014."* The system boundary included the entire life cycle of the corrugated product, extending through manufacturing, use, recovery, and end of life, as shown in Figure 1. The product system was separated into four life cycle stages:

- 1) **Pulp and papermaking operations** includes forest operations, transportation of wood to chipping, off-site chipping, on-site production of chips, off-site production of market pulp, production of on-site produced pulp, papermaking operations (to produce containerboard), conversion into rolls, and supporting activities (on-site steam and power production, on-site chemical production, effluent treatment, on-site waste management, etc.).
- 2) **Converting** includes the activities involved in converting the linerboard and corrugating medium into corrugated packaging.
- 3) **Use** includes transportation to the use phase, but does not include energy and resources used during the use life cycle stage or the waste generated from use other than the product itself.
- 4) **End-of-life** includes end-of-life management of the packaging product (landfilling, burning with energy recovery).

Each life cycle stage is supplied by resources and necessitates residual management. Transportation between two life cycle stages is included in the downstream stage.

¹ This number is higher than that reported by AF&PA (2015). AF&PA's number (47%) include containerboard produced in the U.S. irrespective of whether it is used domestically or exported. The utilization rate of 52% reflects the fact that fewer 100%-recycled products are exported than other types of products, making the domestic utilization rate higher.

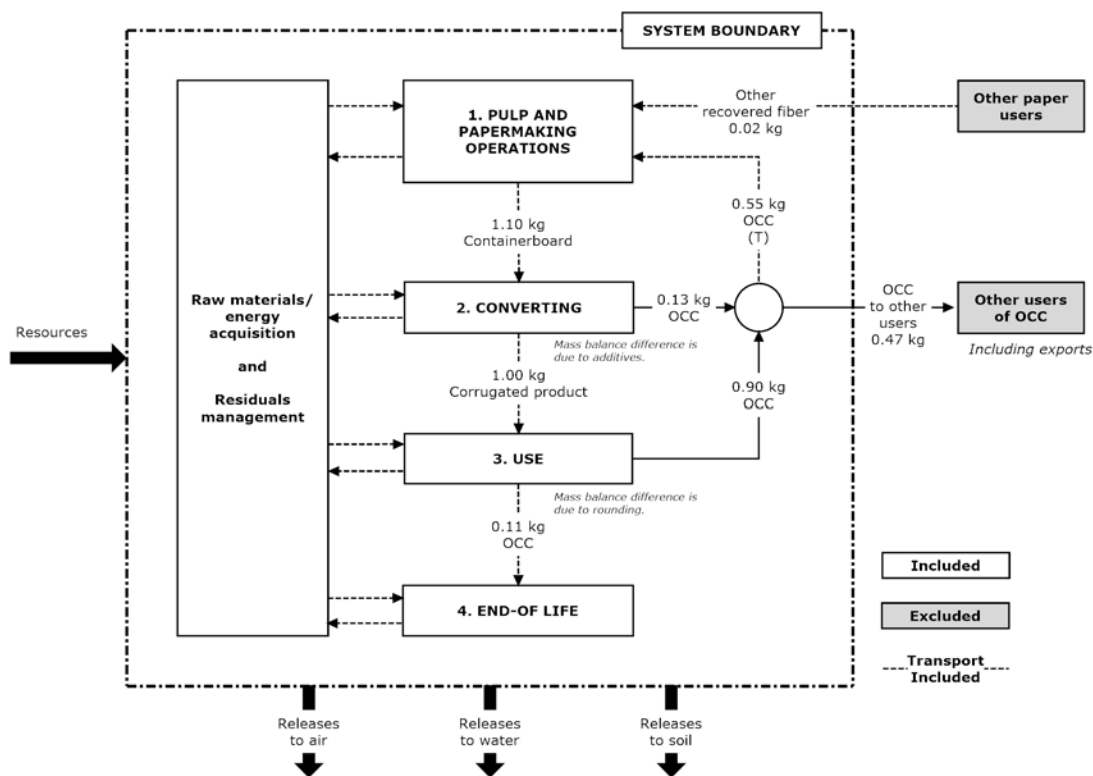

Figure 1. System Boundary

Instead of applying cut-off criteria for data completeness, attempts have been made to be as comprehensive as possible. The data for the study were obtained from the following sources.

- Data on water inputs, environmental loads, solid waste management, and energy (quantity and types of fuels) for the relevant pulp and paper mills were drawn from responses to the 2014 AF&PA Environmental, Health, and Safety Survey.
- Information on quantity of energy used, fiber input, furnish production, and chemical consumption (quantity and type) at the department level was collected in a supplemental survey.
- Data regarding the emissions of toxic substances (as defined by the U.S. Toxic Release Inventory) were modeled using U.S. LCI and NCASI information.
- Data on nutrient content of treated wastewater effluents from pulp and paper mills were derived from available information in the U.S. EPA Permit Compliance System database (www.epa.gov/enviro/html/pcs/); these data are insufficient to allow characterization of effluents from the specific mills in the database, but they do allow general characterization of effluents from U.S. pulp and paper mills.
- Data submitted by the industry in connection with the TSCA Inventory Update Rule (IUR, www.epa.gov/iur/) were used to estimate quantities of kraft pulping co-products (e.g., turpentine and tall oil) produced; the IUR data were not sufficient to characterize every mill in the database, but were sufficient to characterize kraft pulping processes in general.
- Converting facilities in the U.S. were surveyed to collect energy and material input, production, and environmental release information.

- Data and models for other aspects of the life cycle (e.g., for landfills) were obtained from a number of government sources, public life cycle databases (U.S. LCI, GaBi, *ecoinvent*), and published studies.

Where allocation was needed to address co-products, the allocation was done using what was considered to be the most suitable method available, with alternative methods being used in sensitivity analyses, as appropriate.

The investigated product system is a hybrid of a closed-loop and open-loop product system because both closed-loop and open-loop recycling occur in the product system. Recycling of converting wastes and old corrugated containers within containerboard production can be described as closed-loop recycling, while imports and exports of recovered fiber to and from the investigated product system are cases of open-loop recycling. An allocation method is required to deal with open-loop recycling. Two different recycling allocation approaches were used in this study: 1) Closed-Loop Approximation combined with the Cut-Off Method, and 2) the ISO 14049 Number of Uses (NOU) method.

The first approach (Closed-Loop Approximation w/Cut-Off Method) was used to characterize the environmental loads of the industry-average product. Using this approach, it was assumed that the entire requirement for recovered fiber in containerboard production was fulfilled from converting wastes and old corrugated containers recovered at their end-of-life (i.e., closed-loop recycling). In other words, no other recovered fiber sources (e.g., mixed papers) were considered for allocation purposes and hence no environmental load from other product systems was brought within the system boundary. In doing so, there was a net export of recovered fiber to other systems because more old corrugated containers are recovered than the containerboard production process actually needs. It was assumed that this net export of recovered fiber leaves the system boundary without an environmental load associated with it (i.e., a cut-off method was used and all the environmental load is considered within the system).

The choice of an allocation approach for recycling can be critical for comparing paper products with different recycled fiber contents (e.g., Galeano et al. 2011, National Council for Air and Stream Improvement 2012). For this reason, two different approaches were used to express the environmental load of the 100%-recycled content product relative to that of the industry-average recycled content product, each of which provides a different perspective on how the environmental load of virgin production processes is shared between all usages of the fiber (i.e., virgin and recycled). The first approach used was the Closed-Loop Approximation with Cut-Off Method described above. The second approach employed was the Number of Uses (NOU) Method described in the ISO 14044 Standard and its accompanying Technical Report (ISO 14049). This second approach was selected for several reasons. Among them is a recommendation from an international working group addressing life cycle inventory issues, as included in a 1996 report by AF&PA (Life Cycle Inventory Analysis User's Guide - Enhanced Methods and Applications for the Products Industry), that this method be used in LCA studies of paper because it is the only one that reflects the complex interactions between virgin and recycled fiber. The main difference between the two methods is that the Cut-Off Method assigns the environmental loads and benefits from virgin material production to the products made of

virgin fiber only, while the Number of Uses method shares the loads and benefits between the product made of virgin fiber and those made of recycled fiber.

The life cycle modeling was done using the GaBi™ software package. Environmental impacts were characterized using the TRACI impact assessment method developed by U.S. EPA, using the Intergovernmental Panel on Climate Change (IPCC) AR5 factors for global warming. In accordance with accepted greenhouse gas accounting practices, biomass-derived CO₂ was tracked separately from fossil fuel-derived CO₂ and other greenhouse gases in the life-cycle inventory. The effects of biomass carbon on the atmosphere were characterized by calculating the net emissions of biogenic CO₂ (emissions minus removals), which were then added to the global warming results. This approach, referred to as flow accounting, was also used in the previous LCA study. In addition, impact indicator results were developed for the following indicators: ozone depletion, photochemical oxidation (smog), acidification, eutrophication, and fossil fuel depletion. Impacts on land use and biodiversity were not quantified as there is no consensus method suitable for forest management. The CML 2001 impact assessment method developed in the Netherlands was used to test the sensitivity of the acidification, eutrophication and smog indicators. Results were also developed for the following additional inventory indicators: non-renewable primary energy demand and renewable primary energy demand based on the method available in GaBi™, as well as water use and water consumption based on life cycle inventory data. Renewable primary energy demand excluded the intrinsic feedstock energy (heat of combustion) of any raw material input that is not used as an energy source in the studied product systems.

Sensitivity analyses were performed on various aspects.

ES.4 Results

This section summarizes the results obtained from this LCA.

ES.4.1 2014 Results: LCIA Profile

The cradle-to-grave life cycle impact assessment (LCIA) results obtained by applying TRACI, the IPCC factors for global warming, and GaBi non-renewable and renewable primary energy demands are shown in Table 1.

The results show that pulp and papermaking operations (primarily containerboard production) are the main contributor to all impact categories except global warming and water consumption. More detail on the global warming indicator is provided in the next section. Pulp and papermaking and converting contribute significantly to water consumption results. Converting is also a significant contributor to most other indicators. End-of-life contributes significantly to the global warming indicator results, but only when the flow approach is used for biogenic carbon accounting. Finally, the use phase (which primarily reflects the impacts of transportation) does not contribute significantly to impact categories.

Table 1. LCIA Results per Functional Unit

Impact category	Unit/FU	Total	Life Cycle Stage Contribution			
			1. Pulp and Papermaking Operations	2. Converting	3. Use	4. EoL
Impact Assessment Indicators						
Global warming, flow accounting*	kg CO ₂ eq.	0.533	3.6%	43.0%	5.5%	47.9%
Ozone depletion	kg CFC-11 eq.	6.89E-08	90.3%	8.9%	0.7%	0.1%
Photo-chemical oxidation (smog)	kg O ₃ eq.	0.122	76.5%	17.7%	4.8%	0.9%
Acidification	kg SO ₂ eq.†	1.19E-2	78.9%	17.5%	1.5%	2.0%
Eutrophication	kg N eq.†	9.46E-4	81.4%	12.0%	1.2%	5.3%
Respiratory effects (particulates)	kg PM _{2.5} eq.	1.23E-3	87.2%	10.9%	0.6%	1.3%
Fossil fuel depletion	MJ surplus	1.73	68.7%	27.4%	3.1%	0.7%
Additional Inventory Indicators						
Non-renewable energy demand	MJ	18.5	72.9%	24.4%	2.1%	0.6%
Renewable energy demand‡	MJ	9.6	92.8%	7.1%	0.0%	0.0%
Water use	kg	41.9	82.3%	17.3%	0.0%	0.4%
Water consumption	kg	13.1	47.4%	51.8%	0.0%	0.7%

NOTE: Percentages not adding up to 100% is due to rounding. *The flow accounting approach was also used in the previous LCA studies. †Total of air and water. ‡Excluding feedstock energy.

ES.4.2 2014 Results: Details on Global Warming

This section presents more details on the global warming indicator. Figure 2 presents how each life cycle stage contributes to individual GHGs. From this figure, the following can be observed:

- Pulp and papermaking is the greatest contributor to all GHGs and removals.
- Removals (primarily due to biomass grown to produce containerboard) offset a large proportion of all GHGs (biogenic CO₂ and other GHGs).
- Emissions of biogenic CO₂ occur mainly at pulp and paper mills.
- Emissions of other GHGs are spread out across pulp and papermaking operations, converting and end-of-life stages.
- Overall, the main contributors to the total global warming indicator are converting and end-of-life.

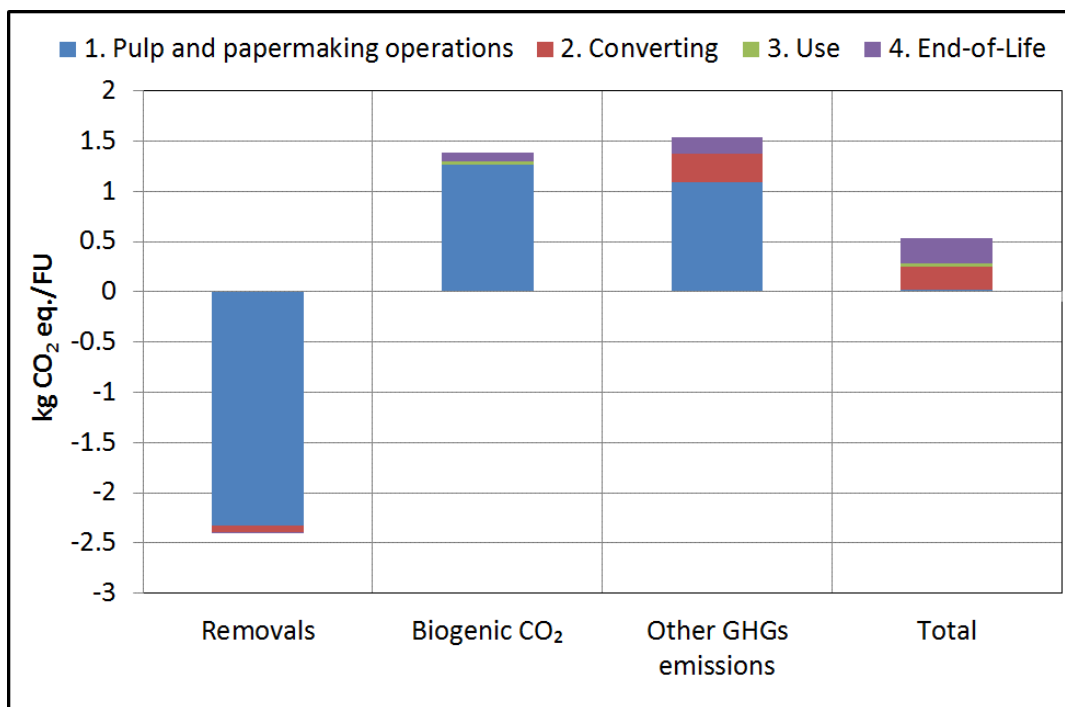

Figure 2. Contribution of the Life Cycle Stages to GHGs

Within the pulp and papermaking operations life cycle stage, forest operations are responsible for removals while energy production is the main process responsible for biogenic CO₂ and other GHG emissions. The rest, for instance chemical production and residuals management, does not contribute significantly to the global warming indicator.

On the converting side, while some removals are associated with chemical (starch) usage, there are very few emissions of biogenic CO₂ because converting facilities do not typically use biomass fuels. A fraction of the biogenic carbon associated with starch is released at the end of life. Other GHGs are distributed across energy (primarily purchased electricity and natural gas), transportation of the containerboard to converting facilities, and chemicals (primarily starch and ink).

At end-of-life, methane from landfills is the main contributor to the global warming indicator. The previous study showed that results for the global warming indicator were sensitive to assumptions regarding landfill gas recovery and burning. The sensitivity analysis was not repeated in this study but the effect is expected to be somewhat less important than in previous studies because less corrugated product was landfilled in 2014 than in 2010.

ES.4.3 2014 Results: Sensitivity Analyses

Sensitivity analyses were performed on various aspects. Some observations from these are as follows.

- As illustrated in Figure 3, the global warming indicator results are sensitive to the approach used to calculate emissions of biogenic CO₂.
- The global warming indicator results are also somewhat affected by the board mix (i.e., ratio of 100%-recycled linerboard, all other linerboard, 100%-recycled medium and all other medium), the quantity of energy used at converting facilities and the recovery rate.
- Somewhat different results are obtained when using the CML and TRACI methods for the eutrophication indicator, mainly because these two methods give priority to different substances released to the environment.

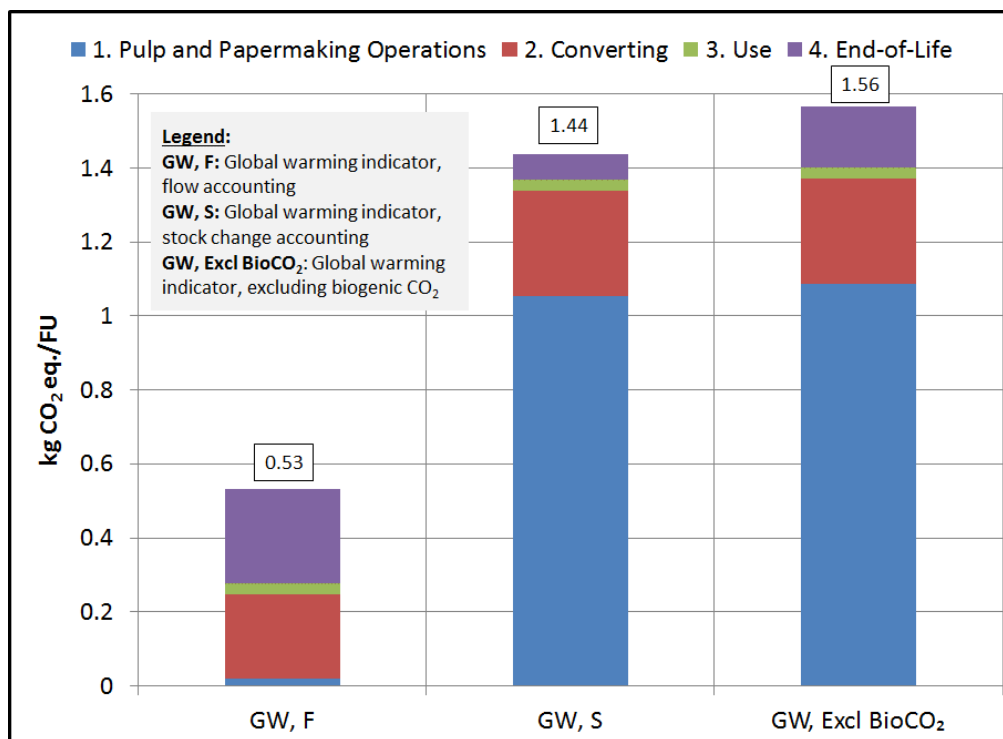

Figure 3. Effect of the Selection of the Indicator on the Observed Global Warming Results

ES.4.4 2014 vs. 2010 Results

One objective of this study was to compare the corrugated life cycle environmental performance in 2014 to that in 2010 and 2006 to document any changes. Table 2 presents an overview of the factors with an effect on the year-to-year comparison.²

² The results published in this report for 2006 and 2010 vary slightly compared to these published in the 2014 report, although the general findings remain unchanged. There are a few reasons for this. First, a calculation error affecting slightly the board mix was found in the original study for 2010 were corrected in this version. Second, some of the data source and impact assessment methodologies were updated. Third, data collection for chemical usage at containerboard mills was streamlined. As a consequence, the 2006 and 2010 datasets were recalculated.

Table 2. Main Drivers for Change in Environmental Performance between 2006, 2010 and 2014

Model parameter	2006	2010	2014	Expected effect on the results
Recovery rate	72%	85%	89.5%	Increasing the recovery rate decreases the quantity of product going to landfill within the system boundaries with the primary effect of reducing GHG releases.
Utilization rate of recovered fiber (kg/kg CBD)	0.42*	0.46*	0.52*	The main anticipated effects of increasing the percent board from recycled fiber, and more specifically increasing the utilization rate, are to reduce the quantity of carbon removal in the system (sequestration), to reduce total energy use at containerboard mills (and more specifically energy from renewable sources) and to reduce water use.
Board from 100%-recycled fibers	22.3%	26.6%	30.5%	
Carbon removal (kg CO ₂ eq./kg CP)	-2.8	-2.6	-2.4	Higher carbon removal reduces the total reported global warming results.
Total fossil fuels used at containerboard mills (MJ HHV/kg CP)	23.8	23.4	22.1	Less energy means lower emissions of GHGs and other air releases.
Share of natural gas in containerboard fossil fuels mix excluding purchased energy	46%	54%	73%	More natural gas in the fuel mix generally results in lower releases of several air pollutants. However, natural gas contributes more towards the fossil fuel depletion indicator (MJ surplus) than other fossil fuels because it is harder to extract.
Total energy used at converting (MJ/kg CP)	2.1	1.9	1.9	Less total energy means lower emissions of GHGs and other air releases. It also means lower total non-renewable energy demand.
Natural gas used at converting (MJ HHV/kg CP)	0.82	1.03	1.09	More natural gas in the fuel mix generally results in lower releases of several air pollutants. However, natural gas contributes more towards the fossil fuel depletion indicator (MJ surplus) than other fossil fuels because it is harder to extract.

NOTE: CBD is for containerboard and CP is for corrugated product.

*Numbers are different than reported by AF&PA. AF&PA numbers include containerboard that is exported. These numbers have been corrected to exclude the exports.

Figure 4 compares the impact scores obtained for 2014 with those obtained for 2010 and 2006. Changes by less than 10% are not considered meaningful (Franklin Associates 2004). From 2010 to 2014 the environmental performance generally remained stable, with most of the environmental improvements occurring between 2006 and 2010. More details regarding the different indicators are provided below.

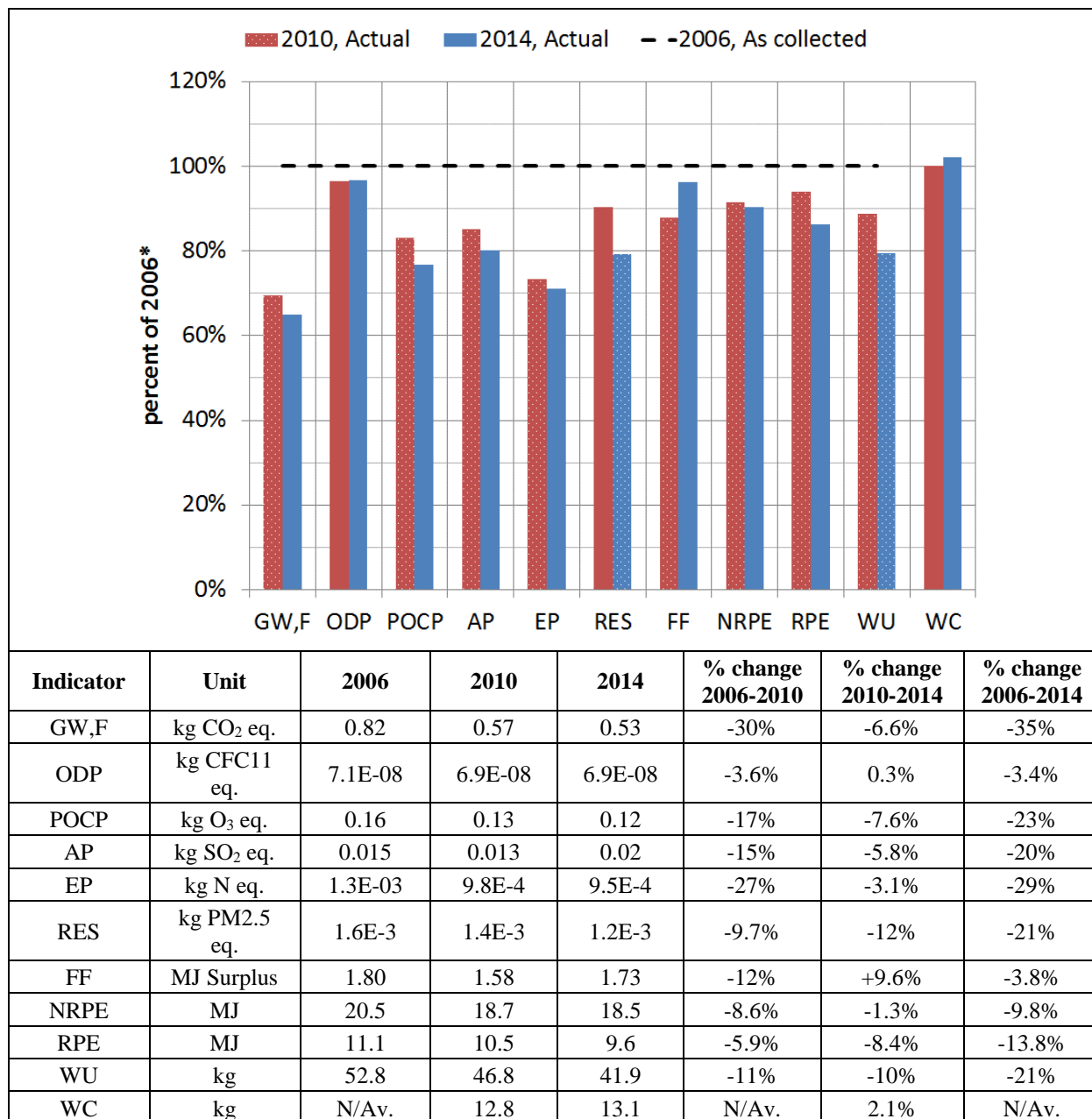

Figure 4. Comparing the Life Cycle Environmental Performance in 2014, 2010 and 2006 (In this figure, the bars with white dots indicate environmental indicators for which the score varied by 10% or more from the previous year. *Except for water consumption for which the reference year is 2010.)

The respiratory effects (particulates) indicator result was reduced by 12% between 2010 and 2014 mainly due to reduction of emissions of SO₂ and particulates from containerboard mills, primarily due to more natural gas in the fuel mix and less combustion of other fossil fuels.

There was a 10% reduction in water use between 2010 and 2014. The reduction in water use occurred mainly in the pulp and papermaking operations life cycle stage. There are two principal sources of water use reduction: water reduction in containerboard mills and, more importantly, a greater share of 100%-recycled products in the board mix. Water consumption remained relatively stable.

Between 2010 and 2014, the global warming indicator (flow accounting; GW,F) result decreased by 6.6%, a change that is not considered meaningful³. Figure 5 provides insight into the different parameters that affected the difference between the two years.

GHGs were reduced in some respects:

- The recovery rate in 2014 was higher than in 2010, resulting in less corrugated containers sent to landfills and in turn decreased methane emissions.
- In 2014, the utilization rate was higher than in 2010, reducing total energy consumption and corresponding direct and indirect releases of GHGs. In addition, the share of fossil fuels from natural gas increased from 2010 to 2014, further reducing GHG emissions.

GHGs were increased in some other respects:

- The higher utilization rate in 2014 corresponds to reduced wood consumption, and hence less carbon removal through sequestration.
- Converting shows a modest increase in GHG releases due to an increased usage of additives (other than starch) and the fact that more containerboard passed through sheet feeder plants, representing more transportation.

Two other global warming indicators were tested in sensitivity analyses: one that uses the stock change accounting method and one that ignores biogenic CO₂. Using these two indicators, emissions of GHGs were reduced by 4% and 6%, respectively. More information concerning the different global warming indicators can be found in Section 5.2.

³ Any change of less than 10% in environmental indicator results is not considered meaningful.

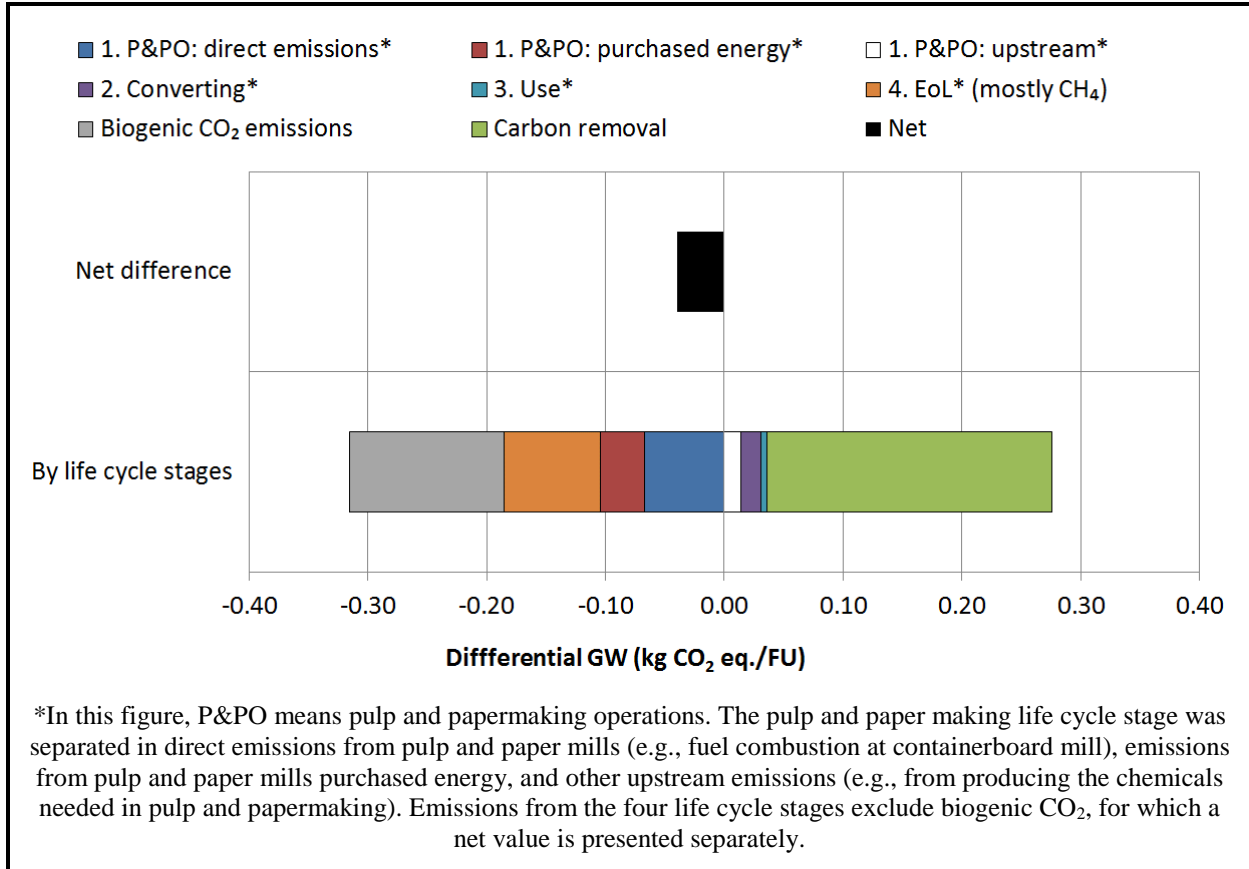

Figure 5. Factors Contributing to Difference in GHG Emissions between 2010 and 2014

Between 2010 and 2014, the impact score for fossil fuel depletion was increased by 9.6%, which is not considered to be meaningful. The main driver for this is increased consumption of natural gas in the life cycle of the product. Total non-renewable energy remained approximately stable. Total renewable energy decreased by 8%, mostly due to an increase in the share of 100%-recycled products in the board mix.

There was no meaningful change in the ozone depletion, smog, acidification and eutrophication indicators.

Sensitivity analyses showed that results of the comparison were generally robust. However, the global warming indicator results are sensitive to the relative contribution of the different board types in the industry-average board mix.

ES.4.5 100%-Recycled vs. Industry-Average

The environmental performance of the 100%-recycled content product relative to that of the industry-average recycled content product was derived using two allocation methods for recycling: the number of uses (NOU) method and the closed-loop approximation with cut-off (cut-off) method. Table 3 presents the main drivers for difference in environmental performance between the two products.

Table 3. Main Drivers for Difference in Environmental Performance between the Industry-Average and 100%-Recycled Products

Model parameter	2014 Industry-Average	2014 100%-Recycled	Expected effect on the results
Utilization rate of recovered fiber (kg/kg CBD)	0.52*	1.23	The main anticipated effects of increasing the percent board from recycled fiber, and more specifically increasing the utilization rate, are to reduce the quantity of carbon removal in the system (sequestration), to reduce total energy use at containerboard mills (more specifically, energy from renewable sources), and to reduce water use.
Carbon removal (kg CO ₂ eq./kg CP)	-2.4	-0.2	Higher carbon removal reduces the total reported global warming results.
Total fossil fuels used at containerboard mills (MJ HHV/kg CP)	22.1	9.70	Less fossil fuels means lower emissions of GHGs and other air releases. It also means lower total non-renewable energy demand.
Total biomass fuels	13.9	0.64	Biomass fuels produce greater air emissions than natural gas.
Net virgin production load transfer (applicable only to the NOU method)	26%†	≈15%‡	Exporting/importing virgin environmental load means exporting/importing environmental impacts (e.g., related to energy production) and benefits (e.g., carbon removal) of producing virgin material.

NOTES: Unless otherwise specified, numbers presented in the table do not account for virgin production load transfer applied with the NOU method. CBD is for containerboard and CP is for corrugated product.

*Number is different than reported by AF&PA. AF&PA numbers includes exports while this number was corrected to account for only domestic use of containerboard. †Meaning that, when accounting for the net generation/use of recovered fiber, 26% of the environmental load from producing virgin fibers in the industry-average is exported to subsequent uses of the fiber. ‡Meaning that, for each kg of recovered fiber (mainly OCC) used in the 100%-recycled product, the environmental load equivalent of producing 0.15 kg of virgin fibers is imported within the system boundaries.

Number of Uses (NOU) Method

The environmental indicator results of the 100%-recycled product relative to that of the industry-average product obtained using the Number of Uses method are presented in Figure 6. The following observations can be made from this figure:

- Using the NOU method, the industry-average product results in lower environmental impact scores for the global warming, smog, acidification, respiratory effects (particulates), fossil fuel depletion, non-renewable energy demand and water consumption indicators.
- Using the NOU method, the 100%-recycled product results in lower environmental impact scores for the renewable energy demand and water use indicators.
- Using the NOU method, there is no significant difference between the industry-average and 100%-recycled products for the ozone depletion and eutrophication indicators.

Sensitivity analyses other than the allocation method for recycling were undertaken to test the robustness of the comparison results. The analyses indicated that the results are relatively robust.

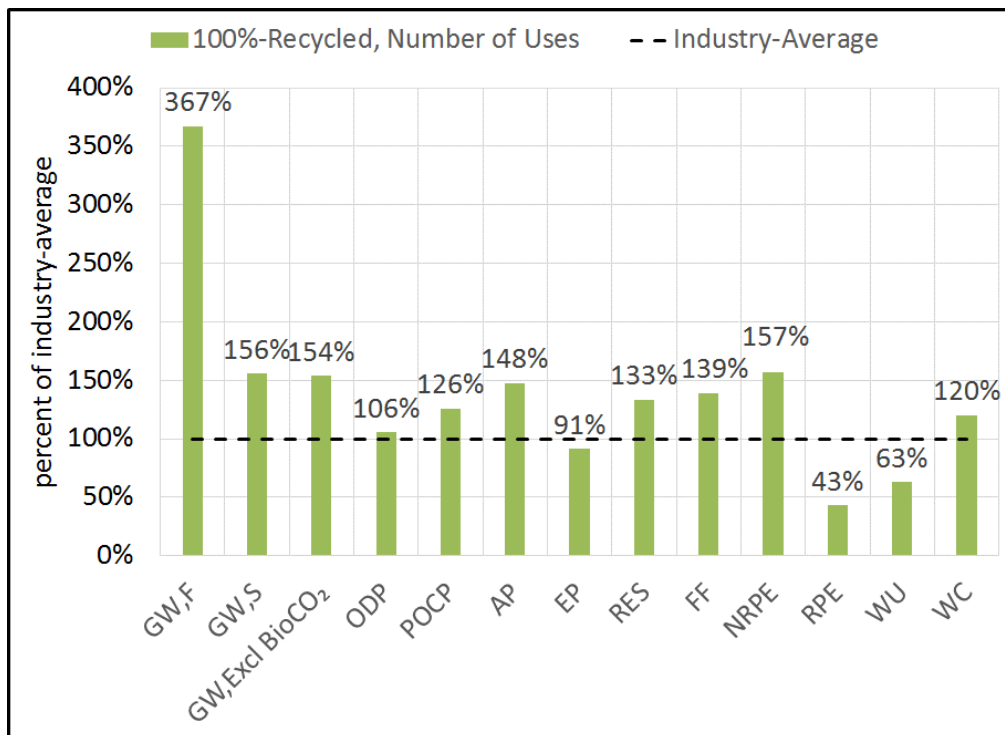

Figure 6. Impact Scores for the 100%-Recycled Product Relative to that of the Industry-Average Product (Number of Uses Method)

Closed-Loop Approximation with Cut-Off Method

The environmental indicator results of the 100%-recycled product relative to that of the industry-average product obtained using the closed-loop approximation with cut-off (cut-off) method are presented in Figure 7. The following observations can be made from this figure:

- Using the cut-off method, the industry-average product results in lower environmental impact scores for the global warming (flow accounting approach) indicator.

- Using the cut-off method, the 100%-recycled product results in lower environmental impact scores for the ozone depletion, smog, eutrophication, respiratory inorganic, renewable energy demand and water use indicators.
- Using the cut-off method, there is no significant difference between the industry-average and 100%-recycled products for the acidification, fossil fuel depletion, non-renewable energy demand and water consumption indicator.

Sensitivity analyses other than the allocation method for recycling were undertaken to test the robustness of the comparison results. The analyses indicated that the results are relatively robust. One exception is worth mentioning. The results for the global warming indicator are very sensitive to the selection of the accounting approach for biogenic CO₂. On one hand, the industry-average product performs significantly better than the 100%-recycled product when using the flow accounting approach. On the other hand, the difference is not significant when applying the stock change accounting method or when ignoring the emissions of biogenic CO₂.

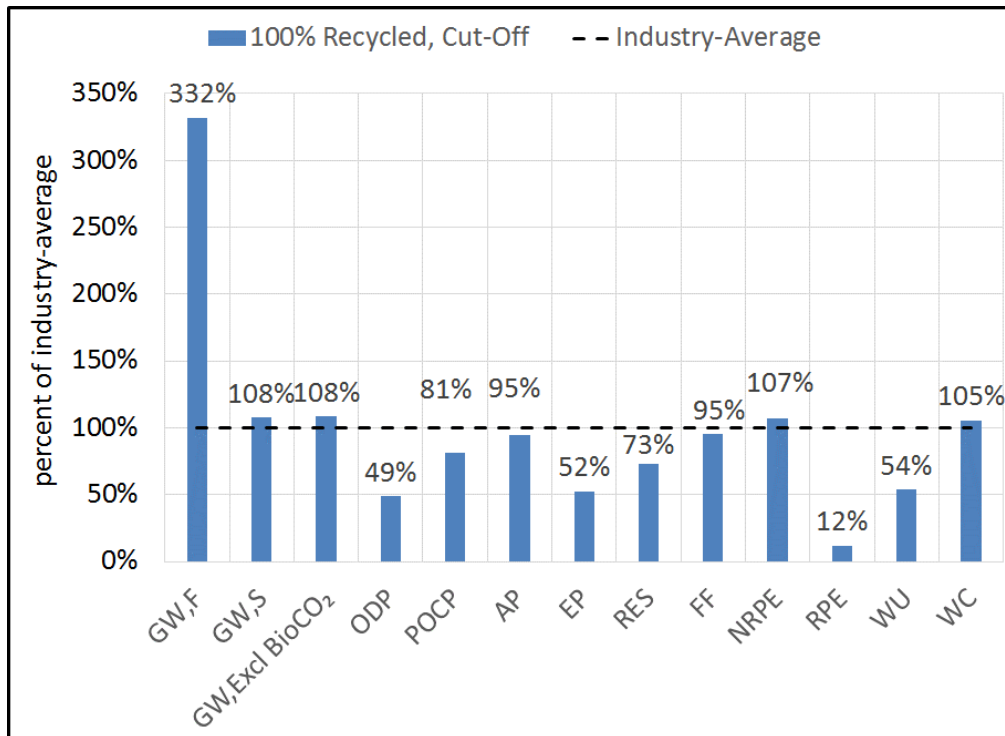

Figure 7. Impact Scores for the 100%-Recycled Product Relative to that of the Industry-Average Product (Closed-Loop Approximation w/ Cut-Off Method)

ES.5 Conclusions

This study represents a comprehensive LCA of the 2014 U.S. industry-average corrugated product. The main conclusions that can be drawn from the study include the following.

Pulp and papermaking production (containerboard) is the main driver of the life cycle environmental performance. For all impact categories, material and energy flows from paper mills dominate the results (positively or negatively). Environmental impacts are dominated by energy demands at the mill. Bio-based energy (e.g., hog-fuel, liquor, etc.) substantially reduces the global warming contribution from mills. Converting facilities also contribute relatively significantly to most impact categories.

End-of-Life is only significant with respect to the global warming indicator results. Other life-cycle impact indicators show little or no response from the end-of-life stage. The global warming potential observed at end-of-life is mainly due to methane released from landfill operations. Sensitivity analyses clearly showed that increasing the recovery rate has the potential to improve overall environmental performance.

The global warming indicator results are highly dependent on the accounting method for biogenic CO₂. Two different accounting approaches can be used to compute the results for the global warming indicator: flow accounting, which was the main method employed in this study, and stock accounting, which was examined in a sensitivity analysis. Flow accounting is the accounting method the most used in LCA studies. Stock change accounting is mostly used in national inventories. Another approach sometimes used in LCA is simply ignoring biogenic CO₂ when calculating the global warming indicator results to get an understanding of how non-biogenic CO₂ GHG contribute to the global warming indicator. Note that this approach ignores any removal/storage of biogenic carbon. The pulp and papermaking operations life cycle went from being an insignificant contributor to global warming when applying the flow accounting approach to a very significant contributor when applying the stock change method or ignoring biogenic CO₂. When applying the stock change accounting approach or ignoring biogenic CO₂, the contribution of end-of-life to the overall global warming results was reduced compared to when applying the flow accounting method.

Overall, the life cycle environmental performance was essentially stable between 2010 and 2014. However, significant improvements were observed for the respiratory effects (particulates) and water use indicators. The main drivers for the reduction in particulate release is the increase share of natural gas in the containerboard mills energy mix. The reduction in water use is mainly due to an increase in recycled content.

The results of comparisons of the industry average product to 100%-recycled product varied by indicator with some results being strongly dependent on the allocation method chosen for recycling. In summary, the industry-average indicator results were lower for the global warming, acidification and non-renewable energy indicators regardless of the allocation method used, although for the non-renewable indicator the results obtained with the cut-off allocation method showed that the difference between the two products was not significant. Results also suggest that the 100%-recycled product generates lower emissions of eutrophying substances and uses less water and renewable energy than the industry-average, although for the eutrophication

indicator the results obtained with the Number of Uses allocation method showed that the difference between the two products was not significant. The results for the other environmental indicators (i.e., ozone depletion, smog, eutrophication, respiratory effects, fossil fuel depletion) depend on the allocation method.

1. INTRODUCTION

The main objective of this LCA was to generate high-quality, up-to-date data on the potential environmental impacts of corrugated packaging. With such a LCA study, the Corrugated Packaging Alliance (CPA) and its constituent associations can assist other organizations in understanding and communicating the environmental footprint and benefits associated with using corrugated packaging rather than other materials. At the same time, the study can help describe the potential environmental impacts of different life-cycle stages in relation to overall environmental performance and the potential environmental benefits of process improvements. The study evaluated the environmental performance of an industry-average corrugated product throughout its entire life cycle. The study is intended to provide useful perspective for different stakeholder groups.

The study was based on information from 42 containerboard mills representing 70% of 2014 U.S. containerboard production and 166 converting facilities representing 23% of overall production volume for 2014.

For this study, a core project team was established to direct, review, and coordinate the activities associated with the methodologies employed, data collection, modeling, presentation and dissemination of the LCI data and corresponding LCA results. The core group for this project consisted of a technical advisory group within the Fibre Box Association (FBA) Sustainability Committee along with various staff from the National Council for Air and Stream Improvement (NCASI).

Life Cycle Assessment is a standardized, scientific method for systematic analysis of flows (e.g., mass and energy) associated with the life cycle of a specific product, technology, service or manufacturing process system. The approach in principle aims at a holistic and comprehensive analysis of the above items, incorporating raw materials acquisition, manufacturing, use and End-of-Life (EoL) management. According to the International Organization for Standardization (ISO) 14040/44 Standards (ISO 2006a, 2006b), a LCA study consists of four phases: (1) goal and scope (framework and objective of the study); (2) Life Cycle Inventory (input/output analysis of mass and energy flows from operations along the product's value chain); (3) Life Cycle Impact Assessment (evaluation of environmental relevance, e.g., global warming potential); and (4) interpretation (e.g., optimization potential).

The goal and scope stage outlines the rationale of the study, anticipated use of study results, boundary conditions, data requirements and assumptions for analyzing the product system under consideration, and other related technical specifications for the study. The goal of the study is defined based upon specific questions that the study seeks to answer, the target audience and stakeholders involved, and the intended use for the study's results. The scope of the study defines the system's boundary in terms of technological, geographical, and temporal coverage, the attributes of the product system, and the level of detail and complexity addressed.

The Life Cycle Inventory (LCI) is merely a list of input and output flows with no associated environmental relevance. LCA characterizes the flows and describes their potential effects on the environment. The Inventory stage qualitatively and quantitatively documents the materials and

| 1. Introduction

energy used (the “inputs”) as well as the products, by-products, and environmental releases in terms of emissions to the environment and wastes to be treated (the “outputs”) for the product system being studied. The LCI data can be used on its own to understand total emissions, wastes and resource use associated with the material or product being studied, or used directly to improve production or product performance. Alternatively, LCI data can be further analyzed and interpreted to provide insights into the potential environmental impacts from the system (Life Cycle Impact Assessment and Interpretation, LCIA).

In order to respond to increasing interest among product manufacturers and consumer retail markets in selecting more sustainable packaging options, CPA engaged NCASI to update the results of a LCA they published in 2014 that relied primarily on 2010 data (http://www.corrugated.org/upload/CPA/Documents/2010_LCA_Final_Report_NCASI_August2014.pdf) to the most recent available data (i.e., 2014 data). In updating this previous study, NCASI updated these data and made minor changes to the methodology where appropriate and corrected calculation errors in the previous data.

The current study has benefited from the cooperation and support of many manufacturers in this sector who contributed their data for use as primary data sources in this report.

2. GOAL OF THE STUDY

The ISO 14044 Standard (ISO 2006b) specifies that “The goal and scope of a LCA shall be clearly defined and shall be consistent with the intended application” and that “Due to the iterative nature of LCA, the scope may have to be refined during the study.”

The goal of this study was to update the LCA published in 2014 using 2010 data for a 1 kg U.S. industry-average corrugated product, with 2014 data. More specifically the objectives of the study were as follows.

1. To educate customers and stakeholders about the environmental attributes of the industry’s corrugated products produced in 2014:
 - a. To identify which life cycle stages contribute the most to these attributes.
 - b. To provide a basis for documenting improvements in these attributes over time.
 - c. To provide information to facilitate any future comparative study.
 - d. To update the data in the U.S. LCI database.
2. To contrast, to the extent possible, the updated results with the results of 2006 and 2010 LCA studies.
3. To present the environmental performance of a corrugated product made of 100%-recycled fiber relative to that of the industry-average recycled content.

The primary audience for this study is CPA, its member companies that produce linerboard, medium and boxes, and their customers. The results will also be disclosed to the public. The study has been conducted according to the requirements of the ISO 14044 Standard (ISO 2006b) and was subjected to a third-party critical review (critical review by an expert interested party).

When results of the LCA are to be communicated to any third party (i.e., interested party other than the commissioner or the practitioner of the study), regardless of the form of communication, a third-party report shall be prepared, according to the ISO 14044 Standard. The third-party report constitutes a reference document, and shall be made available to any third party to whom the communication is made. It is the intent of this report to act as a third-party report.

It is important to note any environmental claim regarding the 100%-recycled product versus the industry-average product (objective #3 above) is a comparative assertion as defined in the ISO 14044 Standard. The results presented in this companion report have been peer reviewed to meet the requirements of the Standard.

3. SCOPE OF THE STUDY

The following section describes the general scope of the project to achieve the stated goal. This includes identification of the average corrugated product to be assessed, the boundary of the study, functional unit, data quality requirements, etc. More information on the methodology employed can be found in Sections 4 and 5.

3.1 Product under Study

3.1.1 2014 Industry-Average Product

The main product being studied is the U.S.-average corrugated product (e.g., corrugated box) manufactured in 2014. Corrugated products are made of corrugated board (combined board). Corrugated board is the structure formed by bonding one or more sheets of fluted corrugating medium to one or more flat facings of linerboard. When this consists of a single facing, it is referred to as single-face board. If bonded on both sides, it becomes double-faced or single wall corrugated board. In addition to singlewall board, doublewall and triplewall corrugated boards are also produced (see Figure 8).

As shown in Table 4, data were collected for different types of board. Because of the relatively low survey response rate compared to previous years, the board mix represented in the dataset was not fully representative of containerboard produced and used in the U.S. For this reason, the data were scaled to be more representative. In general, recycled board was under-represented in the collected information.

Table 4. Mix of Boards in 2014 U.S.-Average Containerboard

Board type	As collected	Actual (as modeled)*
100%-recycled linerboard	9.6%	16.1%
All other linerboard	66.0%	50.7%
Total linerboard	75.6%	66.8%
100%-recycled corrugating medium	6.8%	14.4%
All other corrugating medium	17.7%	18.8%
Total corrugating medium	24.4%	33.2%

*Estimated based on U.S. actual production excluding imports.

Typically, corrugated products are used as secondary packaging⁴ of products for shipping. The average basis weight of the U.S. industry mix is 131.6 lb/thousand square feet (msf, 0.643 kg/m²) and consists of approximately 0.6% singleface, 90.9% singlewall, 8.0% doublewall, and 0.5% triplewall.

⁴ It is sometimes convenient to categorize packages by layer or function: "primary", "secondary", etc. Primary packaging is the material that first envelops the product and holds it. Secondary packaging is outside the primary packaging, perhaps used to group primary packages together.

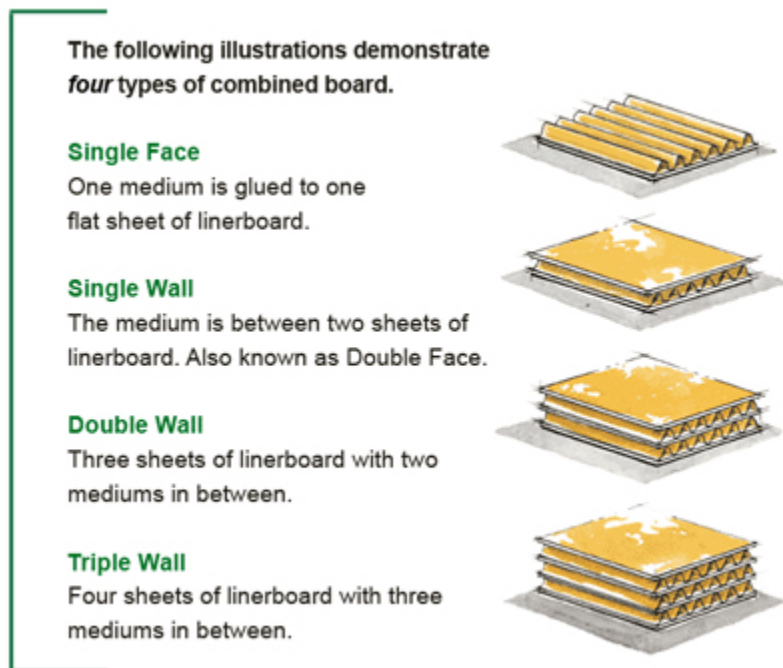

Figure 8. Various Structure of Corrugated Board
[from www.corrugated.org]

3.1.2 2014 vs. 2010 and 2006 Industry-Average Products

As mentioned above, the 2014 data were scaled to match the board mix actually produced, as was done previously for the 2010 data. This was not possible using 2006 data because of the way the data were collected. The board mixes in 2006, 2010, and 2014 are presented in Table 5. As highlighted in light gray in the table, because the utilization rate of recovered fiber was likely to have a significant effect on the results (see more details in Section 4.2.1.3), it was decided to compare the yearly environmental performances based on the "2006, as collected", "2010, actual", and "2014 actual" datasets. However, given that this implies doing a comparison based on slightly different methodologies, the "2006, as collected" dataset was also compared to the "2010, as collected" dataset in a sensitivity analysis in the 2014 report (National Council for Air and Stream Improvement Inc. (NCASI), 2014). This comparison was repeated in this report.

Table 5. Mix of Boards in U.S.-Average Containerboard (2006, 2010 and 2014)

Board type	2006		2010		2014	
	Collected	Actual	Collected*	Actual*	Collected	Actual
100%-recycled linerboard	10.8%	10.0%	10.3%	13.5%	9.6%	16.1%
All other linerboard	61.5%	57.3%	66.6%	55.3%	66.0%	50.7%
Total linerboard	72.3%	67.3%	76.9%	68.8%	75.6%	66.8%
100%-recycled corrugating medium	7.9%	12.3%	7.3%	13.1%	6.8%	14.4%
All other corrugating medium	19.8%	20.4%	15.9%	18.1%	17.7%	18.8%
Total corrugating medium	27.7%	32.7%	23.1%	31.2%	24.4%	33.2%

*Calculation errors found in the original study for 2010 were corrected in this version. Results for the 2010 LCA were recalculated to account for this error and updates in some of the data source were recalculated in updated information is presented in this report. Note that the general findings of the 2010 LCA remain unchanged.

More details on the methodology employed to compare 2006, 2010 and 2014 environmental performance can be found in Appendix B.

The average basis weight of industry-average product was:

- 138.6 lb/thousand square feet (msf, 0.677 kg/m²) in 2006;
- 131.9 lb/thousand square feet (msf, 0.644 kg/m²) in 2010, or 4.8% lower than in 2006; and
- 131.6 lb/thousand square feet (msf, 0.643 kg/m²) in 2014, or 5.1% lower than 2006 and 0.2% lower than 2010.

This report compares the annual environmental profile of industry-average corrugated product on the basis of the same mass of product. However, reduction in basis weight in theory means that, from year to year, less product (on a mass basis) is required to perform the same function. For this reason, the effect of basis weight reduction is discussed in a sensitivity analysis.

3.1.3 100%-Recycled Product

As shown in Table 6, data were collected for different types of boards. When comparing industry-average and 100%-recycled products, the same mix of linerboard to corrugating medium was considered. It was also assumed that the average basis weight of the 100%-recycled was the same as that of the 2014 industry-average.

This means that the environmental attributes of the 100%-recycled product discussed in this report are those of a 100%-recycled product that is functionally equivalent of that of the industry-average product and do not represent the actual “industry-average” 100%-recycled produced and used in the U.S.

Table 6. Mix of Boards in U.S.-Average Containerboard

Board type	Industry-Average as Modeled	100%-Recycled as Modeled
100%-recycled linerboard	16.1%	66.8%
All other linerboard	50.7%	0%
Total linerboard	66.8%	66.8%
100%-recycled corrugating medium	14.4%	33.2%
All other corrugating medium	18.8%	0%
Total corrugating medium	33.2%	33.2%

*Estimated based on U.S. actual production excluding imports.

3.2 Representativeness

Representativeness is an assessment of the degree to which the data reflect the true population of interest. In this study, the population of interest is plants producing containerboard and converting containerboard in the U.S. Table 7 provides information on the technology representativeness of the data collected for this study. It shows that, overall, 70% of the 2014 U.S. production of containerboard was included in the study. Board made from anything other than 100%-recycled fiber was well represented, while 100%-recycled products are relatively less well represented, especially 100%-recycled corrugated medium. Note that, when producing the industry average, the actual board mix was used. This eliminated the bias due to under-represented board types in the industry average. However, it was assumed that the data collected for each individual board type were representative of the average for that board type. It was also assumed that the mills for which data were collected were spread out geographically in a way that was representative of the average. The potential effect of lower representativeness of the 100%-recycled corrugated medium is discussed later in the report.

The data collected for converting plants represented a lower proportion of the U.S. production but it was still assumed that they were representative of the average.

Table 7. Estimated Technology Representativeness of Containerboard Mills and Converting Plants (2014)

Product type	Percent of U.S. Production Included*	Mills/Plants Included	Total Mills/Plants in U.S.*
100%-recycled linerboard	50%	10	20
All other linerboard	89%	27	35
100%-recycled corrugated medium	40%	11	27
All other corrugating medium	76%	14	23
Containerboard - Overall	70%	42	77
Corrugator plants	N/Av	128	473
Sheet feeder plants		7	
Sheet plants		31	
Converting - Overall	23%**	166	1206

*Estimated. **Percent of the containerboard produced and converted in the U.S.

3.3 Function, Functional Unit and Reference Flows

The **function** of the product system under study is the domestic use of an average U.S.-produced corrugated product mainly used as secondary packaging of products for shipping.

The **functional unit** is defined as:

“The domestic use⁵ of 1 kg of an average corrugated product produced in the U.S. in 2014.”

The materials that would be enclosed within the corrugated product while in use of the corrugated product are not included in the study. Note that the function and functional unit described above are not directly intended for comparative analyses. This is because not all packaging has the same functionality at the same mass. In cases where the results would be used for comparative analyses, it should be demonstrated that the compared products perform similar functions.

The **reference flows** are thus defined as the different process outputs for the production of 1 kg of a corrugated product. Quantitative information on the reference flows is provided in the next section (see Figure 9).

The product system investigated delivers functions other than that of the defined functional unit. Examples include: 1) managing the wastes from other systems (through use of recovered paper), and 2) producing raw material for other systems (through recovery of old corrugated containers for subsequent recycling, turpentine production, etc.). These functions are excluded from the scope of this study through the application of appropriate allocation procedures (see Section 3.5).

3.4 System Boundary

3.4.1 Overview of the Product System

The corrugated product system was investigated in this study and is depicted in Figure 9. The system boundary was set according to a cradle-to-grave approach (from raw material extraction to the final disposal of the corrugated product). Containerboard is the primary raw material in the converting process, which results in the corrugated product.

The system boundary, as illustrated in Figure 9, has been separated into four life cycle stages: 1) pulp and papermaking operations, 2) converting, 3) use, and 4) end-of-life.

1) Pulp and papermaking operations includes forest operations, transportation of wood to chipping, off-site chipping, on-site production of chips, off-site production of market pulp, production of on-site produced pulp, papermaking operations (to produce containerboard), conversion into rolls, and supporting activities (on-site steam and power production, on-site chemical production, effluent treatment, on-site waste management, etc.).

⁵ The ratio of the different board types produced in the U.S. (100%-recycled linerboard, all other linerboard, 100% corrugating medium and all other medium) was adjusted to account for the exports of these respective board types. As such, the LCA results are representative of corrugated products produced and used in the U.S. rather than produced in the U.S. irrespective of where they are used.

3. Scope of the Study

- 2) **Converting** includes the activities involved in converting the linerboard and corrugating medium into corrugated packaging.
- 3) **Use** includes transportation to the use phase, but does not include energy and resources used during the use life cycle stage.
- 4) **End-of-life** includes end-of-life management of the packaging product (landfilling, burning with energy recovery).

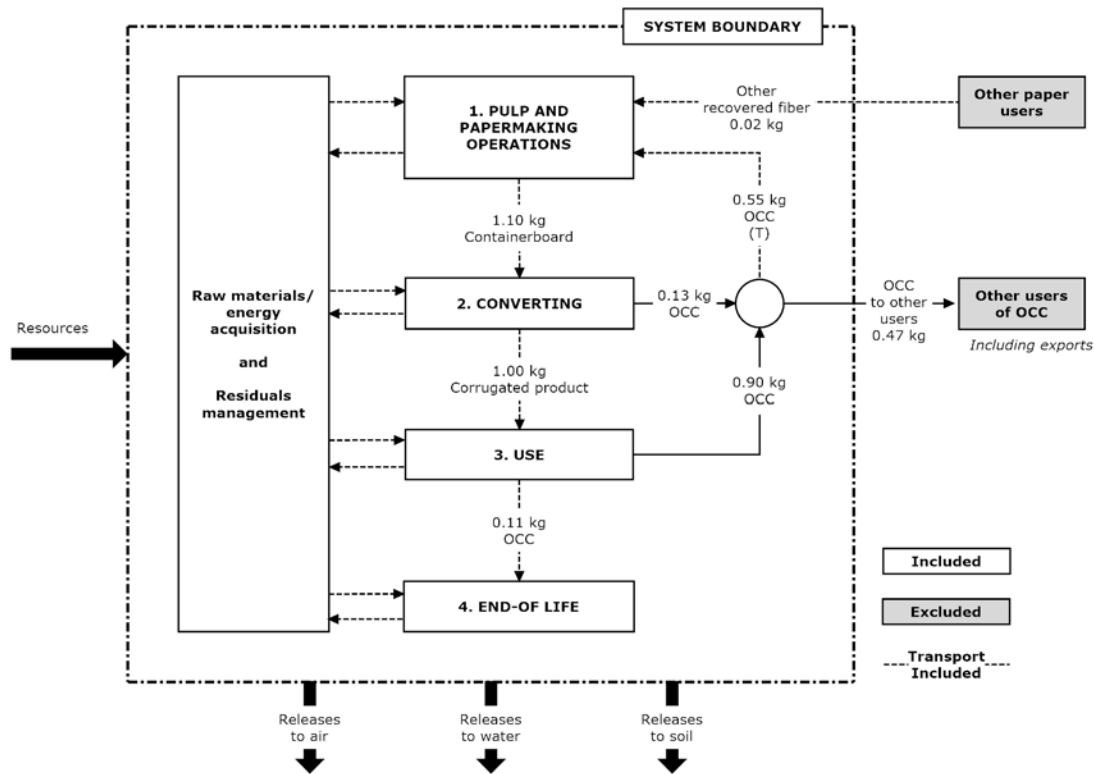

Figure 9. System Boundary for the Corrugated Product System

In addition, as shown in Figure 9, each life cycle stage comprises upstream raw material extraction and production, downstream management of residuals, and transportation between related unit processes. Transportation between two life cycle stages is included within the downstream stage. Each life cycle stage and related unit processes are discussed in detail in Section 4.2.

3.4.2 Omissions/Exclusions

The study did not include capital equipment and maintenance, maintenance and operation of support equipment, or transport of employees. In addition, the study did not include energy related to the use of the packaging product, nor that of the product packaged by it.

Other overhead functions such as HVAC and lighting were included to the extent they are considered in total mill energy usage as reported by participating companies.

3.4.3 Geographic Boundary, Temporal Boundary and Summary of Unit Processes Included

The geographical boundary relates to various aspects in LCA, given that:

- the resources involved may come from different regions of the world;
- the infrastructure, such as transport systems, energy production (electricity grid, for example) and waste management, differ in different regions; and
- the sensitivity of the environment to various pollutants varies from one geographical area to another.

The temporal boundary of a LCA includes the period associated with the functional unit, considering the periods of production, distribution, use (lifetime), and management at the end of product life, along with the period of effect of the substances emitted to the environment. In this study, the period associated with the functional unit is the year 2014. All activities related to the production of corrugated products during this calendar year were therefore included within the temporal boundary of the system. It should be noted that some processes within this boundary can generate releases over a longer period (e.g., landfills). These delayed emissions were annualized and added to the 2014 inventory data. A life cycle impact assessment (LCIA), which is one step in a LCA, considers the full range of persistence and effect of the substances emitted into the environment and thus would capture this type of longer release. The modeling approach and time horizon for evaluation is defined by the LCIA method selected.

Boundaries are summarized in Table 8.

3. Scope of the Study

Table 8. Summary of Boundary Conditions

Life cycle stage and/or unit process	Temporal boundary (Reference year is 2014)	Geographic boundary	Processes included and excluded
Raw material and fuels extraction and production: Fiber	Annual average emissions over a growth cycle and annual average emissions for producing the logs/chips/recycled fiber	Area from which the wood and recycled fiber is obtained and transformed (may include U.S. and Canada, depending on the paper grade)	<u>Included</u> : thinning, harvesting, intermediary transportation ⁶ ; <u>Excluded</u> : capital equipment and maintenance, human activities
Raw material and fuels extraction and production: Chemical and fuels ⁷	Average annual amounts of fuels consumed and other non-fiber inputs during the reference year	Raw material and fuels assumed to be produced in North America (excluding Mexico)	<u>Included</u> : production of raw material and fuels required in all life cycle stages; <u>Excluded</u> : capital equipment and maintenance, human activities
Raw material and fuels extraction and production: Electricity ⁶	Average annual amounts of electricity consumed during the reference year	Grid-specific electricity for pulp, paper and production of final products U.S. grid for end-of-life North American grid for others	<u>Included</u> : combustion and pre-combustion; <u>Excluded</u> : capital equipment and maintenance, human activities
Pulp and papermaking operations	Annual average emissions	All locations where pulp and containerboard are produced including: <ul style="list-style-type: none"> • <u>Market pulps</u>: U.S. and Canada • <u>Containerboard</u>: U.S. 	<u>Included</u> : on-site chipping, pulping, papermaking, converting, steam production, on-site chemical production, on-site waste management, transportation from upstream life cycle stages and intermediary transportation, etc.; <u>Excluded</u> : capital equipment and maintenance, human activities
Converting	Annual average emissions	All locations where corrugated packaging is produced (U.S.)	<u>Included</u> : converting operations, transportation from paper production; <u>Excluded</u> : capital equipment and maintenance, human activities
Use	Time during which products are used	All locations where corrugated packaging is used (U.S.)	<u>Included</u> : transportation from converting plants; <u>Excluded</u> : capital equipment and maintenance, human activities, energy and resources for using the corrugated packaging
End-of-life	Time for maximum degradation	All locations where corrugated packaging is disposed of (U.S.)	<u>Included</u> : emissions from end-of-life activities, transportation from use life cycle; <u>Excluded</u> : capital equipment and maintenance, human activities
Off-site waste management ⁶	Time for maximum degradation	All locations where waste management occurs	<u>Included</u> : emissions from waste management, transportation to the management site; <u>Excluded</u> : capital equipment and maintenance, human activities

⁶ Intermediary transportation is transportation between two unit processes within the same life cycle stage.

⁷ As mentioned before, supply of raw materials and energy as well as off-site waste management were integrated within the life cycle stage they supply. However, they have specific boundary conditions.

3.5 Allocation Procedures

Two types of allocation issues were accounted in this study: allocation related to co-products and allocation related to recycling. More specifically, the main allocation situations that were encountered in this study are:

- sawmill co-products (lumber, chips and wood residues);
- internal allocation, i.e., containerboard mill co-products (different grades of paper produced at the same mill);
- containerboard mill by-products (e.g., turpentine and tall oil, sold energy)⁸;
- containerboard mill beneficial uses (e.g., land application of wastewater treatment plant residuals); and
- recycling (to and from the studied system).

The methods selected for the allocation situations are described and justified in the next sections.

3.5.1 General Considerations in Selecting Allocation Methods

Appendix A discusses the different options described under the ISO 14044 Standard to deal with co-products and recycling allocation. As discussed in this Appendix, ISO 14044 recommends dividing the unit process to be allocated into two or more sub-processes and collecting the input and output data related to these sub-processes (system subdivision) or expanding the system boundary (system expansion) as the preferred options for dealing with allocation for co-products and recycling allocation situations. In the literature, there is general agreement that system subdivision applies regardless of the study objective, but that system expansion is better suited to LCAs with the objective of analyzing consequences of a change in a product system (e.g., Baumann 1996, Baumann and Tillman 2004, Ekvall 1999, Ekvall et al. 2005, Ekvall and Weidema 2004, Werner 2005a). In this study, the objective was to characterize the environmental attributes of the corrugated products and not to analyze the consequences of a change in a given product system. Hence, system subdivision was always used where possible and system expansion was never selected as a first choice.

3.5.2 Sawmill Co-Products

The data available in the U.S. LCI database for sawmill co-products were developed by CORRIM⁹ (Kline 2004, Milota 2004, Milota et al. 2004, Wilson and Sakimoto 2004) using mass allocation. This choice was not modified, although using mass allocation falls within the last option for allocation under the ISO Standard. A previous study (NCASI 2010) showed that the choice of the allocation method for sawmill co-products has little effect on the cradle-to-grave results when chips are the studied product from the sawmill. For this reason, no sensitivity analysis was performed on this choice of allocation method.

⁸ Note that the ISO 14044 Standard does not make any distinction between co-products and by-products. In fact, it does not use the "by-product" terminology. However, as different allocation methods were used for containerboard co- and by-products, the two nomenclatures are used here.

⁹ The Consortium for Research on Renewable Industrial Materials (CORRIM) is a research organization that develops a scientific base of information relating to the environmental performance of wood based building products.

3.5.2.1 Internal Allocation

A given containerboard mill can produce several paper products (containerboard products and non-containerboard products). If only some of the products from the mill are among those being studied, this requires that the environmental load¹⁰ of the containerboard mill be partitioned (allocated) between the studied product and the other products. The first strategy used in this study to resolve this internal allocation problem was to subdivide as much as possible the containerboard mill into its various departments and to collect data specific to these departments (system subdivision) while, at the same time, minimizing the data collection load for participating mills. More specifically the following data were collected and used for applying system subdivision:

- mill-level releases and fuel consumption;
- quantity of each product produced in the mill;
- quantity of each fiber furnish produced at the mill and in which product it is used;
- quantity of each fiber furnish purchased by the mill and in which product it is used;
- quantity of fiber inputs (e.g., wood, recovered paper) for each of the fiber furnishes produced in the mill;
- total heat energy used by each department;
- total electricity used by each department; and
- quantity of other raw materials (e.g., chemicals, paper additives) used by each department.

However, system subdivision was not sufficient to fully resolve the internal allocation problem, and additional allocation methods were required to allocate specific fuels and releases to the various products.

Fuels were allocated using underlying physical relationships by applying, to the extent possible, the process-based hierarchy originally proposed by AF&PA (1996) and extended by NCASI for the purposes of this LCA. This hierarchy is presented in Table 9. Fuel-related releases were allocated based on fuel consumption.

¹⁰ In this report, an environmental load is any input flow or non-product output flow to and from a unit process or set of unit processes.

Table 9. Proposed Allocation Hierarchy for Fuels

Fuels in Order of Allocation		Processes in Order of Allocation	
1.	Fuels for specific usage*	1.	Specific usage*
2.	Black liquor solids, and TMP steam recovery	2.	Wood pulping, and chemical recovery†
3.	Self-generated bark and wood wastes	3.	Bleaching of wood pulps
4.	Purchased bark and wood wastes, fossil fuels and steam	4.	Paper production (wood pulps only)
		5.	Recovered fiber pulping, bleaching and paper production

*For instance, the fuels allocated to on-site electricity production should reflect the steam that goes through the turbine. If all boilers are connected to the turbine, then a proportional fuel mix should be allocated to electricity production. If only recovery boilers are connected to the turbine, then only black liquor solids should be allocated to electricity production. †For kraft pulping, combining pulping and chemical recovery into a single unit process will often facilitate the allocation.

Purchased electricity was allocated based on each department’s consumption.

Non-toxic (as defined by the U.S. Toxics Release Inventory), non-fuel-related environmental releases for which data are collected at the mill level were allocated using a modified mass allocation method developed by NCASI, documented in Appendix F. This NCASI method is a hybrid of underlying physical relationships and other relationships in the ISO hierarchy of approaches.

Toxic releases (as defined by the U.S. Toxics Release Inventory) to air, water and soil were modeled.

Since this approach is as close as possible to avoiding allocation and applying underlying physical relationships under the ISO hierarchy of approaches, no sensitivity analysis was performed.

3.5.2.2 Containerboard Mill’s Co-Products

There are two main co-products that required allocation: turpentine and tall oil, and sold energy.

The quantity and value to the industry of turpentine and tall oil are usually small compared to those of containerboard products. For this reason, different allocation procedures are unlikely to have a significant effect on the results and thus, mass allocation was used (other relationship in the ISO hierarchy) and no sensitivity analysis was performed.

Fuels and combustion-related emissions were allocated to either energy used in the mill and/or energy sold, based on energy content and the hierarchy discussed in Table 9. System expansion was used as a sensitivity analysis because it is used extensively for electricity consumption in both accounting and change-oriented LCAs.

3.5.2.3 Beneficial Uses

Solid residuals from containerboard manufacturing are commonly used for beneficial uses such as agricultural or silvicultural land application, construction materials, chemical feedstock, or

fuels. Another example of beneficial use of waste is burning of used products at the end of life, with energy recovery. The functions related to these beneficial uses are outside the scope of this LCA, and thus an allocation procedure must be applied. As a conservative simplification, the residuals, even if they are beneficially used, were not considered as co-products but as waste and no allocation was required.

3.5.2.4 Recycling

As shown in Figure 9, there are some recycling-related activities that occur in the investigated product system:

- converting wastes that are recycled within containerboard production;
- old corrugated containers that are recycled within containerboard production;
- imports of recovered fiber from other product systems (mainly mixed papers); and
- exports of recovered fiber to other product systems (mainly U.S. paperboard production and foreign exports).

The ISO 14044 Standard and ISO 14049 technical report distinguish between two types of product systems: closed-loop product systems and open-loop product systems. The investigated product system is a hybrid of a closed-loop and open-loop product system because both closed-loop and open-loop recycling occur in the product system. Recycling of converting wastes and old corrugated containers within containerboard production can be described as closed-loop recycling, while imports and exports of recovered fiber to and from the investigated product system are cases of open-loop recycling. The ISO standard specifies that a closed-loop procedure (i.e., no allocation needed) applies to closed-loop systems and that an open-loop procedure (i.e., some sort of allocation method needed) applies to open-loop systems, meaning that an allocation method should be selected for the “open-loop” component of the product system investigated.

Several methods can be used for allocation related to open-loop recycling to determine how the environmental load from virgin material production, recycling processes and end-of-life should be distributed among the different products in the fiber life-cycle (i.e., between virgin and recycled products using the same fiber). More specifically, the ISO Standard provides the following examples: apply a closed-loop procedure to an open-loop system (if applicable), use a physical property as the basis for allocation, employ the economic values of the virgin and recycled material, or apply the number of subsequent uses of the recovered material. Methodological choices in LCA, including the choice of allocation procedures, need to be consistent with the goal of the study. This study included two main objectives: (1) to document the environmental attributes of the industry-average corrugated product over time, and (2) to present the environmental performance of a corrugated product made of 100%-recycled fiber relative to that of the industry average recycled content. These two different objectives required the selection of an allocation method to be made separately.

Evaluation of the Industry-Average Corrugated Product

The approach that was used in this study for the industry-average product is illustrated in Figure 10. It was first assumed that the entire need for recovered fiber in containerboard production was fulfilled from converting wastes and old corrugated containers recovered at their end-of-life (Closed-Loop Approximation). In other words, no other recovered fiber sources from outside the

3. Scope of the Study

system boundary (e.g., mixed papers) were considered for allocation purposes. In doing so, no environmental load from other product systems was considered to come with the use of recovered fiber. Also, there was a net export of recovered fiber to other systems because more old corrugated containers were recovered than the containerboard production process actually needed. It was assumed that this net export of recovered fiber left the system boundary without an environmental load associated with it. This is a conservative approach that avoids distorting the system impacts. This is often referred to as the Cut-Off or Recycled-Content Method.

This method is not specifically mentioned in the ISO 14044 Standard, or its accompanying ISO 14049 Technical Report. However, the ISO Standard is not stringent regarding which allocation method should be applied. It was selected because it is the method that best describes the direct environmental load from U.S. corrugated production without any distortions from potential interactions with other product systems. Also, it does not require complex assumptions, as would have been the case for other methods.

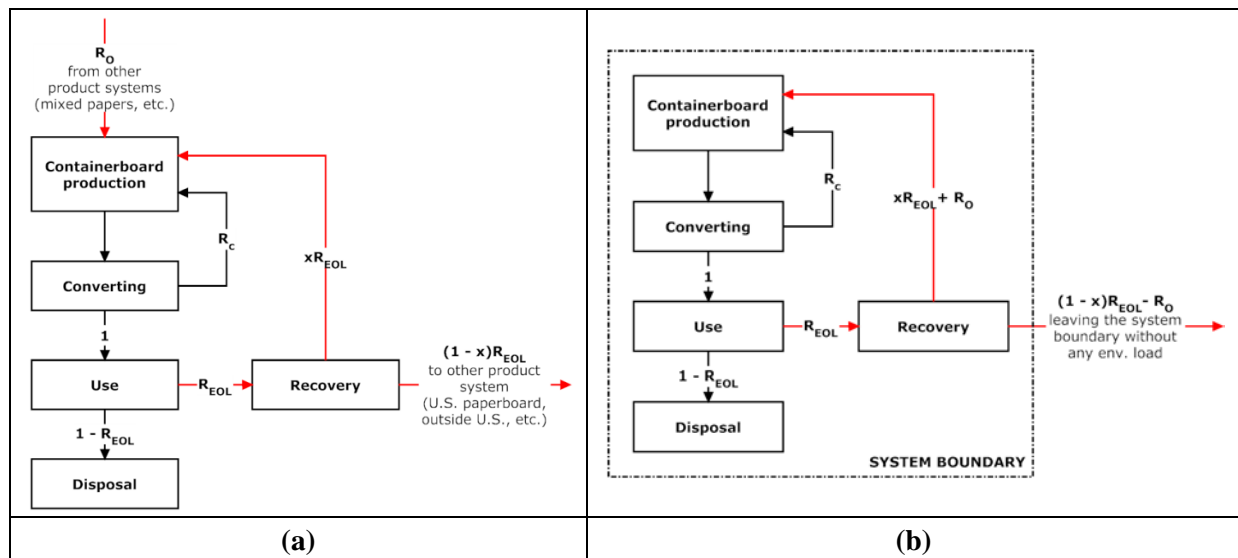

Figure 10. Schematic Illustration of Open-Loop Recycling Allocation Method Used in this Study a) Actual Product System, b) Product System Modeled for Open-Loop Recycling
(In this figure, the flows of recovered fiber are shown in red. R_o is the quantity of recovered fiber imported from other product system, R_c is the converting wastes, R_{EOL} is the quantity of old corrugated containers recovered at their end-of-life, and x is the fraction of this quantity that is recovered within U.S. containerboard production.)

Expressing the Environmental Performance of the 100%-Recycled Content Corrugated Product Relative to that of the Industry-Average Recycled Content Corrugated Product

When performing the LCA on the industry-average corrugated product, it was not necessary to distribute the environmental loads from virgin production, recycling processes and end-of-life between products with different recycled fiber contents, at least within the corrugated product system. When attempting to express the environmental performance of the 100%-recycled corrugated product relative to that of the industry-average product, however, it is necessary to make a decision on how these environmental loads should be distributed. There are several different methods that can be used, none of which have gained consensus as a favored method. Furthermore, it has been demonstrated that the selection of an allocation method is critical to a

3. Scope of the Study

comparison of products with different recycled fiber contents (e.g., Galeano et al. 2011, National Council for Air and Stream Improvement 2012).

The ISO 14044 Standard (ISO 2012b, p. 14) specifies that *"whenever several alternative allocation procedures seem applicable, a sensitivity analysis shall be conducted to illustrate the consequences of the departure from the selected approach."* For this reason, in this study, two methods that each express a different perspective have been applied to express the environmental performance of the 100%-recycled product relative to that of and the industry-average product: the Closed-Loop Approximation w/ Cut-Off method, also used for the industry-average LCA and described above, and the ISO 14049 Number of Uses Method (ISO 2012b). The Number of Uses method:

- Was specifically developed with paper products in mind and is the only one that directly addresses the complex relations between virgin and recycled fiber;
- Has been recommended by an international working group addressing LCI issues as the recommended practice for recycling, especially in cases where the objective is to compare products with various recycled fiber contents (American Forest & Paper Association 1996, National Council for Air and Stream Improvement 2010); and
- Is directly specified as an option in the ISO 14044 Standard.

The Cut-Off and Number of Uses methods express different perspectives on how environmental loads should be distributed among virgin and recycled products and, as a result, using the two methods is expected to give an adequate range of possible results. The two methods are summarized in Table 8.

Table 10. Comparison of the Cut-Off and Number of Uses Methods

	Cut-Off	Number of Uses
Virgin production process	Allocated to the virgin product	Allocated proportionally to all uses of the fiber
Recycling process	Allocated to the recycled product	Allocated to the recycled product
End-of-life	Allocated to the product system in which it occurs	Allocated to the product system in which it occurs
Perspective	Each product system should be assigned only the environmental load <u>directly</u> caused by that system Promotes the use of recycled material as long as the environmental load of the recycling is lower than that of virgin material production	Virgin material production is necessary to obtain resources that are valuable to multiple product systems Promotes the use of recyclable products and end-of-life recovery for recycling

More details regarding the application of each method are presented in Appendix G.

3.6 Data Quality Requirements

The main data quality requirements are presented in Table 11. These are based on the updated pedigree matrix approach by U.S. EPA (Edelen and Ingwersen 2016). The correlation of these quality indicators with ISO requirements is shown in the table. In addition, in alignment with the ISO standard, consistency and reproducibility will be discussed, data sources will be reported, and uncertainty will be addressed. While for non-comparative assessment ISO does not specify which data quality indicators should be included for stand-alone LCAs, the study included an evaluation of all data quality indicators to facilitate future comparative assessment as this is required for that type of LCA.

Table 11. Data Quality Requirements

Data Quality Indicator	Corresponding ISO requirement	Score				
		1	2	3	4	5
Reliability	Precision Completeness	Verified data based on measurements	Verified data partly based on assumptions/calculation OR non-verified data based on measurement	Non-verified data partly based on qualified estimates	Qualified estimates; data derived from theoretical information	Non-qualified estimates
Temporal correlation	Time related coverage Representativeness	< 3 years difference to the reference year	< 6 years difference to the reference year	< 10 years difference to the reference year	< 15 years difference to the reference year	Age of data unknown OR > 15 years difference to the reference year
Geographical correlation	Geographical coverage Representativeness	Same resolution and area of study	Within one level of resolution and a related area of study	Within two levels of resolution and a related area of study	Outside of resolution but related to area of study	From a different or unknown area of study
Technological correlation	Technology coverage Representativeness	All technology categories are equivalent	Three of the technology categories are equivalent	Two of the technology categories are equivalent	One of the technology categories are equivalent	None of the technology categories are equivalent
Representativeness/ Data collection methods	Completeness Representativeness	Representative data from >80% of the relevant markets, over an adequate period	Representative data from > 50% of the sites relevant for the market considered over an adequate period to even out normal fluctuations	Representative data from only some sites (<< 50%) relevant for the market considered OR > 50% of sites but for shorter periods	Representative data from only one site relevant for the market considered OR some sites but for shorter period	Representativeness unknown or data from a smaller number of sites AND from shorter period

(Table continued on next page.)

3. Scope of the Study

Table 11. (Cont'd)

Data Quality Indicator	Corresponding ISO requirement	Score				
		1	2	3	4	5
Technological correlation	Technology coverage Representativeness	Data from enterprises, processes and material under study (i.e., identical technology)	Representative data from 60-79% of the relevant market , over an adequate period OR representative data from >80% of the relevant market, over a shorter period of time	Representative data from 40-59% of the relevant market, over an adequate period OR representative data from 60-79% of the relevant market, over a shorter period of time	Representative data from <40% of the relevant market, over an adequate period of time OR representative data from 40-59% of the relevant market, over a shorter period of time	Unknown OR data from a small number of sites AND from shorter periods
Process review	N/A	Documented reviews by a minimum of two types of third party reviewers	Documented reviews by a minimum of two types of reviewers, with one being a third party	Documented review by a third-party reviewer	Documented review by an internal reviewer	No documented review
Process completeness	Completeness	>80% of determined flows have been evaluated and given a value	60-79% of determined flows have been evaluated and given a value	40-59% of determined flows have been evaluated and given a value	<40% of determined flows have been evaluated and given a value	Process completeness not scored

3.7 Comparison between Systems

In this study, two comparisons between systems were performed. The first one consisted of comparing the environmental performance of the industry-average corrugated product produced in 2006, 2010, and 2014. This comparison does not qualify as a comparative assertion under ISO 14044. Although the basis weight varies from year to year, the products made in year 2006, 2010 and 2014 were assumed to be functionally equivalent for comparison purposes. In practice, a lower basis weight (such as observed in 2010 and 2014) may have meant that less product is required to fulfill the same function if the functional unit would have been expressed in surface or volume of packaging. Hence, the approach taken for comparing corrugated product produced in different years was conservative as the basis weight goes down with years. Note also that data collection procedures and other methodological considerations were not fully compatible for the 2006 in comparison to the 2010 and 2014 studies.

The second comparison consisted of expressing the environmental performance of the 2014 100%-recycled product relative to that of the 2014 industry-average product. This comparison qualifies as a comparative assertion under the ISO 14044 Standard. In a comparative study, according to the ISO 14044 Standard, the equivalence of the systems being compared must be evaluated before interpreting the results. For undertaking that comparison, it was assumed that 1 kg of 100%-recycled corrugated product was functionally equivalent to 1 kg of industry-average product. Consequently, products were compared using the same functional unit and equivalent methodological considerations, such as performance, system boundary, data quality, allocation procedures, decision rules on evaluating inputs, and outputs and impact assessment.

4. LIFE CYCLE INVENTORY

4.1 Data Collection Procedures, Main Data Sources and Validation

In this section, the data collection procedures for foreground and background processes are explained. Foreground processes are those for which specific data were collected (i.e., containerboard production and converting) while background processes are those for which secondary data sources were used (e.g., chemical production, purchased energy production, etc.). More details on data collection for the 2006 and 2010 model can be found in their final report (<http://www.corrugated.org/upload/CPALCAfinalreport08-25-10.pdf>, and http://www.corrugated.org/upload/CPA/Documents/2010_LCA_Final_Report_NCASI_August2014.pdf).

4.1.1 Data Collection Procedure: Foreground Processes

Data collection was performed as follows for containerboard production.

- Data on water inputs, environmental loads, solid waste management, and energy (quantity and types of fuels) for the relevant pulp and paper mills were drawn from responses to the 2014 AF&PA Environmental, Health, and Safety Survey.
- Information on quantity of energy used, fiber input, furnish production, and chemical consumption (quantity and type) at the department level were collected in a supplemental survey.
- Data regarding the emissions of toxic substances (as defined by the U.S. Toxics Release Inventory) were modeled using U.S. LCI and NCASI information (NCASI 2001, NCASI 2015, NREL 2012).
- Data on nutrient content of treated wastewater effluents from pulp and paper mills were derived from available information in the U.S. EPA Permit Compliance System database (<https://www.epa.gov/enviro/pcs-icis-overview>); these data are insufficient to allow characterization of effluents from the specific mills in the database, but they do allow general characterization of effluents from U.S. pulp and paper mills.
- Data submitted by the industry in connection with the TSCA Inventory Update Rule (IUR, www.epa.gov/iur/) were used to estimate quantities of kraft pulping co-products produced (e.g., tall oil and turpentine); the IUR data were not sufficient to characterize every mill in the database, but were sufficient to characterize kraft pulping processes in general.

The converting facilities for producing corrugated products in the U.S. were surveyed to collect energy and material input information, production, and environmental release information.

Data were recorded as production-weighted means.

4.1.2 Data Collection Procedure: Background Processes

Background processes were modeled using publicly available life cycle inventory databases. The strategy employed to select which database to use is depicted in Figure 11. In summary, the U.S. LCI database (NREL 2012) was used as a priority because it is the main source of U.S.-specific

life cycle inventory data. NCASI updated the data for electricity production with the most recent available data. The GaBi Professional database (PE Content, © PE International) was used as a secondary option based on the study commissioner's preference (PE INTERNATIONAL AG 1992-2013). Finally, the ecoinvent 2 database (Frischknecht et al. 2005) was used to fill any remaining data gaps. As the use of different databases can lead to inconsistencies, a verification of relative significance was made when either the GaBi Professional database for a non-U.S. dataset or the ecoinvent database was used.

A detailed list of unit processes used is presented in Appendix D.

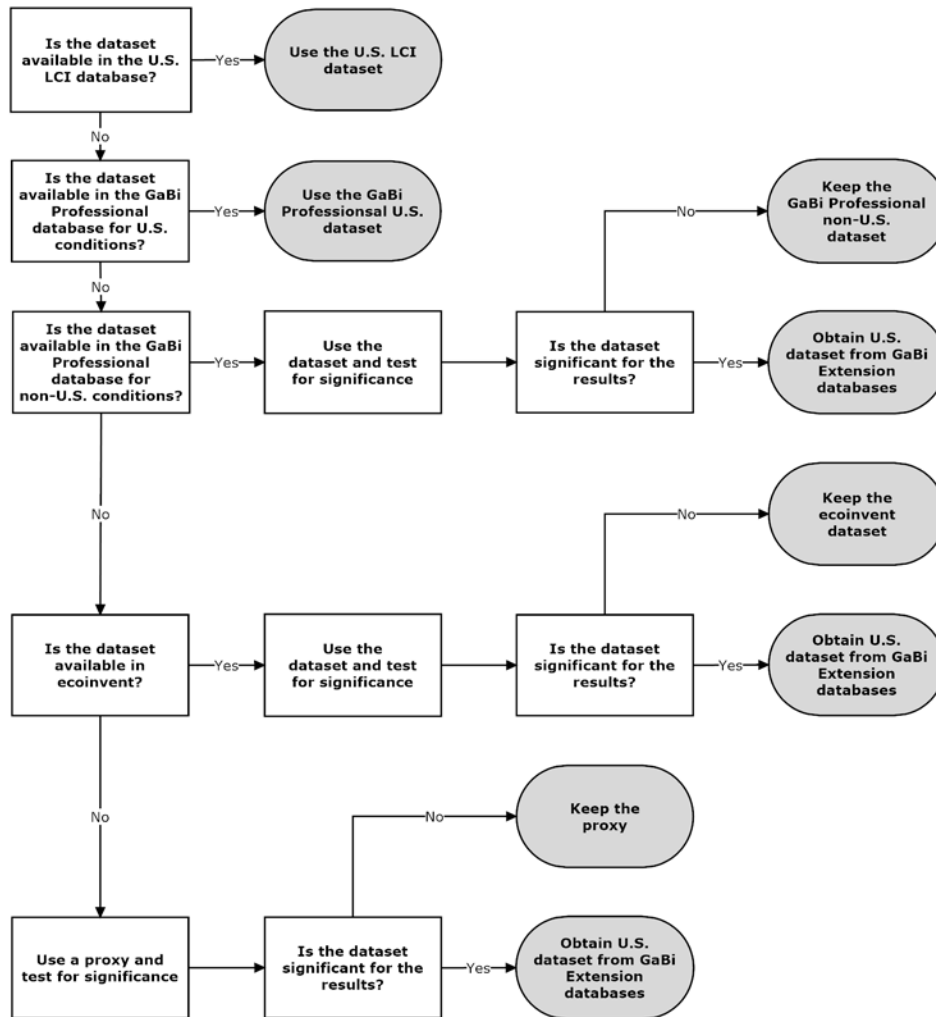

Figure 11. Data Collection Strategy for Background Processes

4.1.3 Summary of Data Sources

Primary data sources are summarized in Table 12.

Table 12. Primary Data Sources

Data required	Data source or assumption(s)
FOREGROUND SYSTEM – Containerboard production	
Material inputs	Supplemental survey
Air releases: Non-toxic	AF&PA Environmental, Health and Safety (EH&S)
Air releases: Toxic	Modeling based on U.S. LCI and NCASI information
Water releases: Non-toxic	EH&S, other sources
Water releases: Toxic	Modeling based on U.S. LCI and NCASI information
Energy data	EH&S
Mill solid waste	EH&S
Mill solid waste management and soil releases	EH&S and modeling based on U.S. LCI and NCASI information
Co-product quantity (e.g., turpentine)	TSCA IUR industry submissions supplemented with literature data as necessary
FOREGROUND SYSTEM – Converting	
All necessary information	Converting facilities questionnaire
BACKGROUND SYSTEM	
Forest operations	CORRIM (Johnson et al. 2004, Oneil et al. 2010) as available in the U.S. LCI database
Chip production	CORRIM (Bergman and Bowe 2010, Milota 2004, Milota et al. 2004, Puettmann et al. 2010) as available in the U.S. LCI database
Chemical and fuel production	Publicly available LCI databases
Electricity production	Weighted grid developed using containerboard/converting facilities' location U.S. LCI and GaBi databases
Corrugated product end-of-life	Ratios based on U.S. average NCASI information supplemented with publicly available databases
TRANSPORTATION	
Distances and modes	2012 U.S. Commodity Flow Survey (United States Department of Transportation and United States Department of Commerce 2015)
Transportation processes	U.S. LCI database

4.1.4 Energy Considerations

Energy requirement calculations were made using higher heating values (HHVs). HHVs account for the total heat content of a fuel when it is burned, some of which provides useful energy to the system in which the fuel is burned and some of which is used to evaporate the water in the combustion products. For life cycle purposes, HHV is a more complete method of energy accounting compared to using the lower heating value (LHV), as LHV does not account for the energy content of the fuel that was used to evaporate the water formed in combustion. For this reason, HHVs were used in this study. The following table summarizes assumptions and data regarding heating values.

Table 13. Heating Values of Fuels for the 2014 Dataset

Material	Unit	Higher Heating Value* (MJ HHV/unit)
Purchased hogged fuel, logging residues	kg	20.9
Purchased hogged fuel, manufacturing residues	kg	18.6
Self-generated hogged fuel, logging residues	kg	20.9
Self-generated hogged fuel, manufacturing residues	kg	18.8
Wastewater treatment plant residuals	kg	15.1
Spent liquor solids	kg	15.4
Non-recyclable paper	kg	13.9
Other biomass	kg	22.0
Wastewater treatment plant/deinking residuals	kg	15.2
Bituminous coal	kg	32.2
Distillate fuel oil (#2)	L	39.8
Gasoline	L	34.8
Kerosene	L	38.3
Liquid propane gas	L	25.5
Natural gas	m ³	38.4
Residual fuel oil (#5, 6)	L	41.7
Rubber tire chips	kg	30.2

*Higher heating values are from AF&PA EHS survey and based on dry weights.

4.1.5 Carbon Contents

Table 14 summarizes data and assumptions regarding the carbon contents of the various materials modeled in this study. Some carbon contents were calculated. The details on these calculations can be found in Appendix B.

Table 14. Carbon Contents of Various Materials

Material	Carbon content	Comment/Source
Wood inputs	50.0%	IPCC (IPCC 2006b, Table 2.4)
Containerboard	49.6%	Calculated by assuming 50% of the fiber content (IPCC 2006b, Table 2.4) and the carbon in added starch. Fiber content was calculated by subtracting the paper additive quantity from the weight of the product. Other sources of carbon were neglected.
Corrugated product and OCC (2014)	49.1%	Carbon contents of corrugated products were calculated using carbon balances.
Black liquor	35.0%	The carbon content of black liquor is variable. A value of 35.0% was used as a first approximation (NCASI 2005). Black liquor carbon content was adjusted to close the carbon balances (see details in Appendix B.2)
Virgin market pulps	50.0%	50% of fiber (IPCC 2006b, Table 2.4).
Recycled market pulps	43.1%	Printing and Writing LCA study (NCASI 2010).
Starch	44.4%	Carbon content was set based on the basic chemical formula of the starch molecule that is $(C_6H_{10}O_5)_n$.
Wastewater treatment plant/deinking residuals	49.0%	Literature review (NCASI 2013a)

4.1.6 Validation of Data

The ISO 14044 Standard requires that a check on data validity be conducted during the process of data collection. The objective is to confirm and provide evidence that the data quality requirements for the intended application have been fulfilled. Validation may involve establishing, for example, mass balances, energy balances and/or comparative analyses of release factors.

4.1.6.1 Quality Assurance

Containerboard Mill Survey

Surveys requesting detailed production and energy and raw material input information were received from 42 containerboard mills. Information provided via the surveys was quality-assured (QA) using a combination of cross-checking with data previously submitted to the AF&PA Environmental, Health and Safety (EHS) survey (which had previously been subjected to a quality-assurance protocol) and by evaluating internal consistency of various data elements based on engineering principles, as summarized below. Issues identified during the QA process were investigated through follow-up correspondence with mill and corporate staff. Where issues could not be sufficiently addressed, the related survey information was omitted from the study. This process resulted in the inclusion of data for all the 42 containerboard mills.

1. The following survey entries were compared to those submitted to the EHS survey:
 - a. Total production.
 - b. Total energy consumption at the facility.

- c. Total water intake entries were compared to total effluent discharge submitted to the EHS survey.
2. Entered quantities of fiber furnish produced on-site were correlated with entered quantities of fiber (wood, recovered paper, etc.) via yield calculations. Additionally, all entered fiber input elements were correlated with furnish elements used in production.
3. Entered quantities of steam consumption were correlated with entered quantities of on-site steam generation, taking into account steam purchases as independently submitted to the EHS survey.
4. Entered energy consumption for various mill processes was correlated with product types (and with on-site electricity production) to ensure consistency.
5. Entered values for water content of various input materials were evaluated.
6. In addition, a “hidden” calculation page embedded in the survey was used to identify any elements where the respondent may have inadvertently modified formulas integral to the survey.

Converting Facility Survey

Surveys requesting detailed production, energy and raw material input, and environmental releases (including material outputs recycled by other facilities) were received from 269 converting facilities. The information provided via the surveys was quality-assured by evaluating internal consistency of various survey data elements based on engineering principles and by comparing with average or median values reported by similar facilities, as summarized below. Issues identified during the QA process were investigated through follow-up correspondence with facility and corporate staff. The process resulted in the inclusion of data for 128 corrugator plants, 31 sheet plants, and 7 sheet-feeder plants (total of 166 converting facilities).

1. A mass balance was performed considering all input materials and outputs of corrugated sheets, finished corrugated products, recycled materials, and solid waste. Agreement of inputs and outputs within 10% was required for a facility’s survey information to be included in the analysis.
2. Energy consumption data entry elements underwent a two-step QA process. Initial evaluation consisted of comparing entries to those of other similar facilities to identify gross errors (e.g., departures of at least one order of magnitude from those of similar facilities) typically associated with erroneous measurement unit entry. Secondary evaluation consisted of identifying potential outliers using statistical outlier tests of total energy intensity (e.g., Dixon’s test). As outlined above, facilities that submitted suspect information were contacted for clarification/confirmation of the information.
3. Entered values for water content of various input materials were evaluated.
4. Entered values for various input materials were evaluated for reasonableness (for example, a sheet feeder plant is expected to consume liner and medium in producing corrugated sheets, whereas a sheet plant is expected to consume corrugated sheets in producing finished corrugated products).

5. Entered values for water intake to the facility were compared with entered values for water releases from the facility.

Parameters Used in Life Cycle Assessment

The quality-assured data received from containerboard mills and from converting operations were used to develop production-weighted mean (PWM) environmental burdens and other parameters required for input to life cycle assessment models for various product grades. The calculations associated with these parameters were internally reviewed by NCASI staff not involved with the development of the calculation methods. In addition, because two years of data were available derived from similar methodologies, it was possible to perform additional QA. While comparing LCA results for 2014 and 2010, it was possible, to some extent, to check and correct some calculations for the 2014 and 2010 LCA model.

4.1.6.2 Mass Balances

Water, fiber and carbon balances were performed for the containerboard production and converting unit processes. Where adequate, the results of the mass balances were used to correct the collected data. More details can be found in Appendix B.

4.1.6.3 Treatment of Missing Data and Cut-Off Criteria

In theory, a LCA study should track all processes in the life cycle of a product, but this is not possible in practice. For this reason, some flows are commonly ignored or “cut off.” The CML guide (Guinee et al. 2002) distinguishes two distinct aspects of cut-off criteria: (1) unit processes for which there are no data, and (2) interventions from relevant unit processes for which there are no data. The following cut-off procedure was applied in this study.

1. Cut-offs were, as much as possible, avoided by collecting process-specific data.
2. Where no process-specific data were found for a given process, estimates were based on a similar process.
3. When estimation is not possible, the flow was cut off and the potential significance of this cut-off assessed (qualitatively or quantitatively).

In addition, specific data were collected for containerboard production processes and manufacturing of final products (converting). The data collection was performed in a way that ensured that any flow contributing to more than 1% of the mass inputs of those processes was included, except for chemicals. Knowledge gained during the previous LCA effort, in terms of the point after which additional data do not add measurable benefit to the robustness of the final LCA results, justified the assessment to include only those chemicals contributing more than 10% of the total dry mass of chemicals used in each containerboard component. In this manner, no chemicals with significant individual contribution to any environmental indicator (i.e. > 5%) would be ignored. Using that cut-off criteria, the following list of chemicals, for which data were collected, was developed:

- Aluminum sulfate;
- Caustic (sodium hydroxide);

- Starch;
- Sulfuric acid;
- Strength agents (wet and dry);
- Lime;
- Soda powder; and
- Pitch dispersants.

In addition, the mills were asked to report the total mass of "other fillers" required to calculate the average carbon content of containerboard. No significant energy input was omitted. All known air-related substances associated with combustion, which are deemed significant through U.S. EPA's TRI (SARA 313) regulation and other national and international combustion-related air contaminant programs, were included for containerboard production and, to the extent they were documented in the selected databases, for other unit processes.

The ISO 14044 Standard also requires that the system boundaries be refined to include processes initially excluded but of potential significance to the results. No unit processes were excluded.

4.2 Detailed Description of the Product System and Related Unit Processes

4.2.1 Raw Material/Energy Acquisition: Wood Fiber

The main raw material used for the production of containerboard is wood fiber (virgin or recycled). Table 15 presents a summary of woody material used to produce 1 kg of corrugated product (CP) or 1.11 kg of containerboard in 2014. Containerboard made from 100%-recycled fiber does not use logs and chips for pulp production. However, some of the containerboard from 100%-recycled fiber is produced at mills that also produce containerboard from virgin fiber. Some of these mills produce more energy using spent liquor and self-generated hogged fuel than they need in their virgin operations. In these cases, it was assumed that extra energy from these fuels was "sold" to the recycled product and hence, the quantity of chips and logs required to produce that sold energy was allocated to the recycled product.

More details on the fiber types used for containerboard production can be found in Appendix E for 2014, in the 2014 LCA report for 2010 data (http://www.corrugated.org/upload/CPA/Documents/2010_LCA_Final_Report_NCASI_August2014.pdf), and in the 2009 LCA report for 2006 data (<http://www.corrugated.org/upload/CPALCAfinalreport08-25-10.pdf>). The discussion in the next sections presents a qualitative description of the unit processes associated with wood fiber acquisition.

Table 15. Woody Material Inputs per Functional Unit

Fiber Type	Quantity (kg/kg Corrugated Product or 1.10 kg Containerboard)				
	Industry-Average			100%-Recycled	
	2014	2010	2006	2014	2010
Wood Inputs					
Hardwood logs ^a	0.14	0.14	0.13	≈ 0.00 ^c	0.00
Softwood logs ^b	0.58	0.69	0.43	≈ 0.00 ^c	0.07 ^c
Purchased hardwood chips ^b	0.10	0.13	0.12	0.00	0.01 ^c
Purchased softwood chips ^b	0.32	0.35	0.48	0.00	0.00
Total wood inputs	1.14	1.31	1.17	0.00	0.084
Recovered Paper					
Recovered paper	0.57	0.51	0.46	1.23	1.25
Purchased Pulps					
Virgin	≈ 0.00	≈ 0.00	≈ 0.00	≈ 0.00	≈ 0.00
Recycled	≈ 0.00	≈ 0.00	≈ 0.00	≈ 0.00	≈ 0.00
Total purchased pulps	≈ 0.00	≈ 0.00	≈ 0.00	≈ 0.00	≈ 0.00

NOTE: Compared to the previous report, 2010 data were corrected to account for an error in the board mix calculation.

^aIncludes the fraction of the log used for energy (e.g., bark).

^bAs opposed to self-generated chips for which the wood quantity is accounted for in logs.

^cTransferred from other products for energy purposes.

4.2.1.1 Forest Operations

The forest operations unit processes are described in reports from the Consortium for Research on Renewable Industrial Material (CORRIM) (Johnson et al. 2004, Oneil et al. 2010). Forest operations include the establishment of hardwood and softwood forest stands, the treatment of those stands through to maturity, and the harvesting of logs from the stands. Data related to stand management incorporate aspects related to the preparation of the site for planting, the planting of seedlings on the harvested site, and intermediate stand treatments to enhance growth and productivity (thinning or fertilization or both). As modeled in CORRIM's reports, harvesting consists of:

- felling (severing the standing tree from the stump);
- processing (de-limbing and/or topping, and cutting of the tree into merchantable and transportable log lengths);

4. Life Cycle Inventory

- secondary transportation (moving trees or logs from the point of felling to a loading point near a haul road); and
- loading (moving logs from loading point to haul vehicles).

The production of the inputs (seedlings, fuel, lubricants, etc.) is also included in this unit process. The inventory data developed by CORRIM are the main source of information for modeling forest operations.

4.2.1.2 Purchased Chip Production

This unit process includes debarking/chipping of roundwood in off-site chipmills and production of chips as a co-product at sawmills¹¹. It does not include chipping operations at pulp and paper mills. CORRIM is the main source of inventory data for modeling the forest and chip production unit processes. However, CORRIM does not provide data for chips produced at chipmills. Hence, it has been assumed that all chips produced off-site are co-products of sawmills. Sawmills can be broken into three main operations: sawing, drying, and planing. Chips are produced as a co-product of the first operation (sawing), which consists of transforming the logs into green lumber.

4.2.1.3 Supply of Recovered Fiber

In 2006, 2010 and 2014, there was some difference in utilization rates of recovered fiber.

- 2006 fiber data were obtained from Fisher International but did not match AF&PA statistics on recovered fiber utilization rate¹². Hence, Fisher fiber data were adjusted to match AF&PA recovered fiber utilization rate, i.e., **0.42 kg/kg of containerboard** or 0.46 kg/kg corrugated product.
- Based on the survey data collected directly from the mills, the utilization rate in 2010 was **0.46 kg/kg** containerboard produced and used in the U.S. (or 0.51 kg/kg of corrugated product). This represents a utilization rate of approximately **0.47 kg/kg** total containerboard produced in the U.S. This compares to a value of **0.47 kg/kg** containerboard reported by AF&PA.
- Based on the survey data collected directly from the mills, the utilization rate in 2014 was **0.52 kg/kg** containerboard produced and used in the U.S. (or 0.58 kg/kg of corrugated product). This resulted in a utilization rate of **0.48 kg/kg** total containerboard produced in the U.S. This compares to a value of **0.47 kg/kg** containerboard reported by AF&PA (2015).

Table 16 shows that recovered fiber used in 2014 containerboard production comes from three main sources: converting wastes, post-consumer old corrugated containers and recovery from other product systems.

¹¹ Environmental load of the sawmilling process is mass allocated between its co-products (lumber, chips, wood wastes).

¹² Utilization rate: quantity of recovered fiber used per unit of production.

Table 16. Types of Recovered Paper Used in Containerboard Production (2014)

Grade of Recovered Paper	Description	Share of Total Recovered Paper Used
Converting wastes (pre-consumer OCC)	Consists mainly of double-lined kraft (DLK), i.e., clean, sorted, unprinted, corrugated cardboard cartons, boxes, sheets or trimmings, must be kraft or jute liner content	21.9%
Post-consumer old corrugated containers (OCC)	Consists of corrugated containers having liners of either test liner, jute or kraft	75.1%
Mixed papers	Broad category that often includes items such as discarded mail, telephone books, paperboard, magazines, and catalogs	1.9%
Pulp substitutes	High-grade paper that often consists of shavings and clippings from converting operations at paper mills and print shops	1.1%

The recovered fiber supply consists of the sorting of used paper (usually from municipal solid waste) and transportation to pulp and paper mills. Sorting operations were neglected for two reasons: (1) there are no data available concerning how much paper comes from municipal sorting operations versus industrial operations, and (2) sorting operations are not expected to be significant to the study results.

4.2.2 Raw Material/Energy Acquisition: Chemicals

Chemicals used in the various life cycle stages are presented in the respective sections of these life cycle stages. Chemical production processes were modeled using secondary data sources (see Section 4.1.2 and Appendix D for more details).

4.2.3 Raw Material/Energy Acquisition: Energy

4.2.3.1 Purchased Electricity

Electricity production was modeled differently for the foreground processes (containerboard production and converting) than for the background processes (all others). The modeling differences are described below.

Foreground Processes

For the containerboard mills, purchased electricity was assigned upstream loads for the electrical grid serving the specific facilities on which the LCA is based (based on eGrid regions).

Containerboard facility location was used to determine the applicable region-specific emission factor. Facility electricity use by product (pro-rated by production mass) was then used to develop the overall electricity mix by product grade, which was different for the industry-average corrugated products and the product made from 100%-recycled fiber, as shown in Table 17.

Table 17. Electricity Mix for Industry-Average and 100%-Recycled Containerboard

eGrid Region	Industry-Average	100%-Recycled
	% of the total purchased electricity obtained from each e-grid region	
East	76.5%	100%*
West	19.6%	0%
Texas	3.9%	0%

**According to data from Fisher International and given the board mix considered in this study, approximately 17% of the 100%-recycled containerboard is produced in the West or in Texas. This indicates that the production of the products from these regions was poorly represented in the collected data. At the industry-average level, the products from the East region are also slightly under-represented, but to a lesser extent. Electricity grid mixes can have significant effect on the results of a LCA. For this reason, sensitivity analyses were included to test the potential effects of this on the results.*

The load for electricity and steam sold by those facilities was not included in the study (see Section 3.5 for allocation procedures).

For converting mills, a 2014 U.S. average power mix was used because the representativeness was lower and because facilities are spread out across the nation.

Background Processes

For all other processes, an average 2014 U.S. grid was used.

Modeling of Electricity Production

The U.S. average, East, West, and Texas consumption grid mixes were modeled using processes from the U.S. LCI database. They were calculated by considering the quantity of power produced in the U.S. by type of fuel, the quantity of power exported, and the quantity imported from Canada and Mexico. The production mix for the United States was calculated using 2014 data from the U.S. Department of Energy, Energy Information Administration (EIA 2015, forms EIA-906, EIA-920 and EIA-923). Data for 2013 from the International Energy Agency (IEA 2016) were used for Mexico, as these were the most recently available. Since electricity imports from Mexico represent less than 1% of the total energy consumed in the U.S., these data are not expected to have a significant effect on the results. 2014 Canadian data were taken from Statistics Canada (2016a, b, c). Table 18 presents the fuel mixes for U.S. average, East, West, and Texas electricity consumption, as well as the datasets that were used to model them.

Table 18. U.S. Average Electricity Grid Fuel Consumption Mix

Fuel type	%				Dataset used
	U.S.	East	West	Texas	
Coal (including CHP)	38.3	41.6	27.0	33.7	Electricity, bituminous coal, at power plant /US
Petroleum	0.6	0.8	0.3	0.1	Electricity, residual fuel oil, at power plant/US
Natural gas (including CHP)	27.3	23.5	30.3	46.3	Electricity, natural gas, at power plant /US
Nuclear	19.5	23.9	7.7	9.0	Electricity, nuclear, at power plant/US
Hydroelectric	7.0	4.5	22.3	0.7	Electricity, hydropower, at power plant/SE (89%), and Electricity, hydropower, at pumped storage power plant/US (11%), from ecoinvent
Wind	4.4	3.2	6.3	9.1	Electricity, at wind power plant/RER, from ecoinvent
Wood and wood-derived fuels (CHP)	1.6	1.7	1.5	0.4	Electricity, biomass, at power plant/US
Others	1.4	0.7	4.5	0.8	As appropriate

4.2.3.2 Purchased Steam

Five containerboard mills reported purchasing steam from local utility plants that operate combined heat and power (CHP) systems compared to seven in 2010.

For the 2010 LCA, detailed information pertaining to the fuels consumed and operating characteristics of five of the utility CHP systems providing steam to the containerboard mills were obtained from the US EPA's eGRID database (U.S. EPA 2013), pertaining to 2009 (2010 data were not yet available from eGRID; it was not possible to definitively identify the utilities supplying steam to two of the containerboard mills). It was assumed that the five utilities for which data were available were representative of the seven. From this information, the fraction of each fuel making up the total fuel input to the five utility CHP systems and the fraction of the total (considering all five utilities) utility fuel input energy that is allocated to the CHP-produced steam (remainder of fuel energy allocated to produced electricity) were calculated using the Efficiency Method as recommended by the WRI/WBCSD GHG Protocol (WRI and WBCSD

2006). In this manner, the average quantities of individual fuels consumed during production of steam by the utility CHP plants serving the containerboard mills were estimated. It was assumed that that steam mix also applies to 2006 and to the 100%-recycled product.

For the 2014, fuel mixes from the most recent eGrid database were checked and compared to that used for the 2010 data. Because the fuel mix was almost identical, the data used in 2010 were also used for the 2014 analysis.

4.2.4 Pulp and Papermaking Operations

Pulp and papermaking operations consist of different unit processes that are depicted in Figure 12. The figure shows the 2014 industry-average product. Each of the unit processes and "sub-unit processes" are described in detail in the following sections.

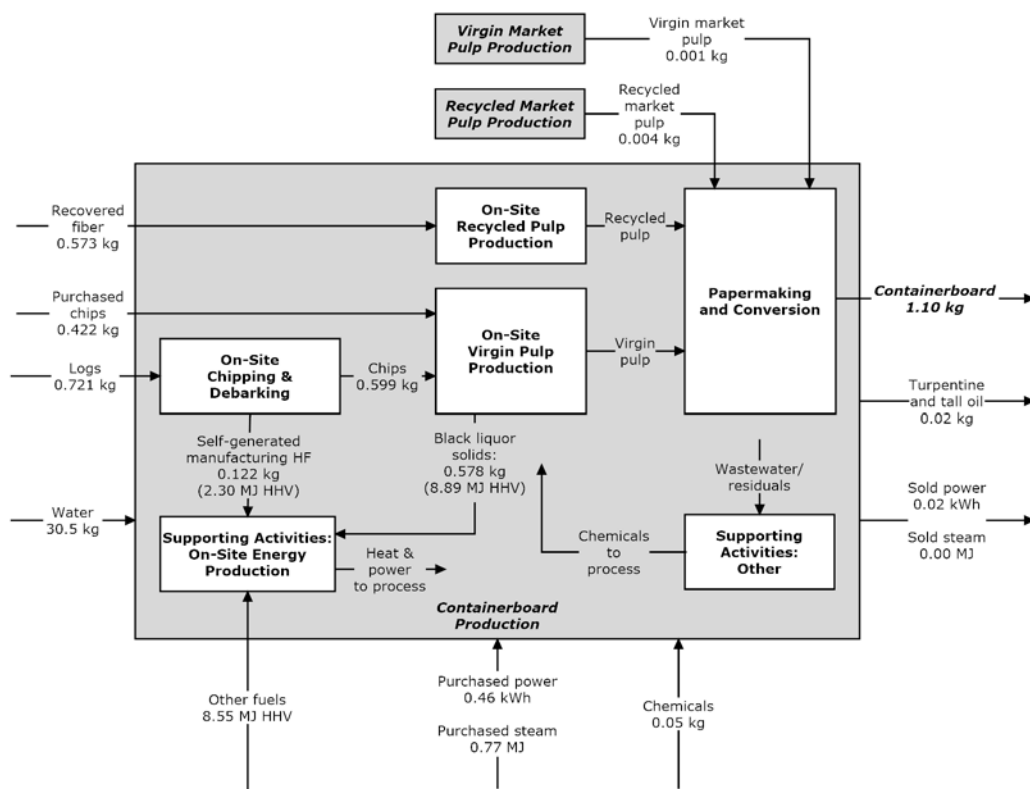

Figure 12. Schematic of Pulp and Papermaking Operations Life Cycle Stage, 2014 Industry-Average (Modeled unit processes are depicted in gray)

4.2.4.1 Market Pulp Production

Some of the fiber requirement is fulfilled using market pulps, both virgin and recycled. Market pulps are pulps produced off-site and transported to containerboard mills.

4.2.4.2 Containerboard Production

The containerboard production unit process consists of several sub-unit processes: debarking and chipping, on-site virgin pulp production, on-site recycled pulp production, papermaking and

4. Life Cycle Inventory

conversion, and supporting activities. While these subcomponents of the containerboard production unit process are described in the next paragraphs, Table 19 presents a summary of the inputs and outputs to the unit processes. The details of all inputs and outputs can be found in Appendix E for 2014.

Table 19. Inputs/Outputs to Containerboard Production Unit Process per Functional Unit

Input/Output	Quantity				Unit ¹³	Comment
	Industry-Average		100%-recycled			
	2014	2010	2014	2010		
INPUTS						
Resources						
Water intake	30.9	37.5	8.49	10.5	kg	Includes process and cooling water.
Fiber Raw Material						
Total wood inputs	1.14	1.31	0.002	0.078	kg	As depicted in Figure 12, total wood inputs include logs and chips both from hardwood and softwood. A fraction of these inputs is used for energy through self-generated hogged fuel (manufacturing) and black liquor solids.
Self-generated hogged fuel manufacturing	0.12 (2.30)	0.15 (2.75)	0.004 (0.07)	0.008	kg (MJ HHV)	
Black liquor solids	0.58 (8.89)	0.65 (9.71)	0.00 (0.00)	0.09 (1.37)	kg (MJ HHV)	
Recovered fiber	0.57	0.51	1.23	1.25	kg	Includes OCC, mixed papers, pulp substitute and high-grade deinking (see Section 4.2.1.3 for more details).
Purchased pulp, virgin	0.001	0.001	0.000	0	kg	Includes bleached and unbleached kraft market pulp.
Purchased pulp recycled	0.004	0.002	0.001	0	kg	Recycled non-deinked pulp.

(Table continued next page. See note at end of table.)

¹³ kg are dry kg, unless specified.

Table 19. (Cont'd)

Input/Output	Quantity				Unit ¹⁴	Comment
	Industry-Average		100%-recycled			
	2014	2010	2014	2010		
Chemicals						
Caustic	7.6E-3	9.0E-3	4.1E-4	4.4E-5	kg	
Sulfuric acid	1.2E-2	1.1E-2	7.0E-4	3.3E-3	kg	
Aluminum sulfate	2.7E-3	3.3E-3	9.2E-4	2.7E-3	kg	
Starch	5.4E-3	3.4E-3	6.1E-3	7.4E-3	kg	
Lime	9.0E-3	4.4E-3	0	0	kg	
Soda	3.6E-3	1.2E-3	0	0	kg	
Pitch dispersant	6.0E-5	2.00E-4	0	4.7E-4	kg	
Strength agents	7.0E-4	5.02E-4	1.6E-3	1.7E-3	kg	
Other fillers	5.5E-3	1.9E-3	1.8E-3	1.9E-4	kg	Includes a variety of papermaking fillers (organic and inorganic)
Energy						
Renewable fuels	2.86	2.28	0.60	1.02	MJ HHV	Includes self-generated logging residues, purchased hogged fuel, as well as other renewable fuels. Self-generated hogged fuel (manufacturing) and black liquor solids are not included here but rather in total wood inputs above.
Fossil fuels	5.69	5.96	4.46	5.37	MJ HHV	Includes coal, natural gas and a variety of other fossil fuels.
Purchased power	1.66	1.45	2.12	2.03	MJ	
Purchased steam	0.77	1.16	2.45	4.10	MJ	
OUTPUTS						
Products and co-products						
Containerboard	1.10	1.11	1.10	1.11	kg	Quantity of containerboard per functional unit
Turpentine and tall oil	0.017	0.018	0	0	kg	
Sold power	0.07	0.02	0	0.03	kWh	
Sold steam	0	0.02	0	0	MJ	

(Table continued next page. See note at end of table.)

¹⁴ kg are dry kg, unless specified.

Table 19. (Cont'd)

Input/Output	Quantity				Unit ¹⁵	Comment
	Industry-Average		100%-recycled			
	2014	2010	2014	2010		
<i>Emissions to air</i>						
Nitrogen oxides (NO _x)	1.56E-3	1.83E-3	7.31E-4	5.08E-4	kg	
Sulfur oxides (SO _x)	1.15E-3	1.78E-3	2.54E-4	4.07E-4	kg	
Total reduced sulfur (TRS), as H ₂ S	7.71E-5	7.0E-5	0	0	kg	
Particulates	6.11E-4	7.20E-4	5.03E-5	1.44E-4	kg	
Carbon monoxide (CO)	2.57E-4	3.12E-4	1.73E-4	2.10E-4	kg	
Carbon dioxide (CO ₂), biogenic	1.23	1.38	0.104	0.075	kg	
Carbon dioxide (CO ₂), fossil	0.331	0.386	0.235	0.311	kg	
Methane (CH ₄), biogenic	1.22E-3	1.65E-3	2.24E-3	5.49E-4	kg	
Methane (CH ₄), fossil	1.3E-5	1.64E-5	5.06E-6	7.22E-6	kg	
Nitrous oxide (N ₂ O)	5.01E-5	6.28E-4	6.64E-6	1.46E-5	kg	
Evaporated water	3.67	4.44	1.35	1.69	kg	Estimated.
Toxics	The releases of toxic substances (as defined by the U.S. Toxics Release Inventory) to air were estimated using NCASI data (NCASI 2001).					
<i>Emissions to water</i>						
Process effluent	26.8	27.5	6.82	8.29	kg	Cooling water is estimated. In some cases, cooling water discharges may have been included within effluent.
Cooling water discharges	1.82	6.84	0.36	0.58	kg	
Adsorbable Organic Halides (AOX)	4.21E-6	5.12E-6	0	0	kg	
Biochemical oxygen demand (BOD ₅)	9.73E-4	1.12E-3	4.63E-4	5.57E-4	kg	
Total suspended solids (TSS)	1.34E-3	1.57E-3	1.46E-4	1.35E-4	kg	

(Table continued next page. See note at end of table.)

¹⁵ kg are dry kg, unless specified.

Table 19. (Cont'd)

Input/Output	Quantity				Unit ¹⁶	Comment
	Industry-Average		100%-recycled			
	2014	2010	2014	2010		
<i>Emissions to water (cont'd)</i>						
Total nitrogen	2.04E-4	2.21E-4	5.09E-5	4.86E-5	kg	
Total phosphorus	3.45E-5	3.44E-5	5.12E-6	4.94E-6	kg	
Toxics	The releases of toxic substances (as defined by the U.S. Toxics Release Inventory) to water were estimated using NCASI data (NCASI 2001).					
<i>Emissions to soil</i>						
Toxics	The releases of toxic substances to soil (as defined by the U.S. Toxics Release Inventory) were estimated using NCASI data (NCASI 2001).					
<i>Residuals</i>						
<i>Note: Landfill and burning were assumed to occur onsite. Land application and other beneficial were assumed to occur offsite.</i>						
Wastewater treatment plant residuals	0.036	0.052	0.064	0.105	kg	Landfilled: 32.6%, land applied: 35.5%; burned: 23.1% and other beneficial: 8.9% (2014).
Wood ashes	0.023	0.046	0.003	0.007	kg	Landfilled: 62.1%, land applied: 10.0% and other beneficial: 27.8% (2014)
Coal ashes	0.006	0.010	0.002	0.003	kg	Landfilled: 62.1%, land applied: 10.0% and other beneficial: 27.8% (2014)
Other solid wastes	0.049	0.0413	0.058	0.039	kg	Landfilled: 68.6%, land applied: 3.6%; burned: 13.0% and other beneficial: 14.8% (2014).

NOTE: 2010 data were revised since the last study.

Debarking and Chipping

Wood delivered to the containerboard mill as logs goes through a de-barking and chipping process to produce wood chips, in addition to chips sourced from sawmills and chip mills. These wood chips, processed to a uniform size, form the raw material for production of virgin wood pulp. This pulp is used, often with additional pulp from recovered fiber, for making containerboard. Containerboard can also be produced from recovered fiber alone, as discussed below.

On-Site Virgin Pulp Production

Cooked in a high-pressure, high-temperature (130-180 °C) digester in a mixture of inorganic chemicals (e.g., sodium hydroxide, sodium sulfide, sodium sulfite, sodium carbonate, etc.) tailored for the desired pulp properties, the wood chips are broken down into wood pulp and spent pulping liquor, with a pulp yield depending on the chemicals used, desired containerboard properties, and cooking parameters.

¹⁶ kg are dry kg, unless specified.

The spent pulping liquor is washed from the pulp, then concentrated and burned to recover the cooking chemicals and provide heat required for containerboard production. The pulp is refined by a series of separation, screening and washing steps before being moved to the containerboard-making process (i.e., the paper machine). At the paper machine, pH is adjusted and additives such as sizing agents are introduced to the pulp slurry to give the final sheet its desired properties.

On-Site Recycled Pulp Production

The recovered paper that is delivered to the containerboard mill is controlled for quality and contaminants before being re-pulped. Re-pulping involves breaking and dispersing the recovered paper bales and loose-fed material in warm process water using mechanical energy. Large pieces of plastic, wires and other materials may be removed within the re-pulping operation using a ragger and other de-trashing equipment. The resulting "stock," a suspension of fiber in water, is then screened through progressively smaller holes and slots and sometimes cleaned centrifugally to remove sand, grit and lightweight contaminants. Some recycled containerboard mills will fractionate and possibly wash the stock to generate streams enriched in long/slender fibers, short/coarse fibers, and fines, which can then be proportioned to different plies in the containerboard machine. Depending on the cleanliness of the recovered paper and the configuration of the particular stock preparation system, between 85% and 95% of the recovered paper can be used to produce recycled containerboard. Some recycled containerboard mills utilize a disperger, a device that heats dewatered stock to 80-110° C and applies mechanical energy to homogenize the pulp and its remaining contaminants. Other mills simply dewater the stock before the containerboard machine. All recycled containerboard mills reuse process water from the containerboard machine and the stock preparation dewatering equipment, resulting in significantly lower fresh water use per ton of containerboard produced than their virgin counterparts.

Papermaking and Conversion

An overview of the papermaking process is shown in Figure 13.

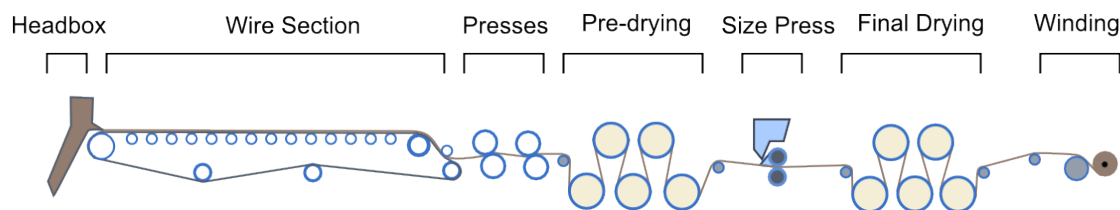

Figure 13. Papermaking Process

The pulp slurry, consisting of a desired blend of virgin and recycled fibers, is fed into the headbox and distributed evenly across the width of the containerboard-making machine. Fed out from the headbox in a homogenous sheet onto "the wire," water contained in the slurry drains through as it moves along this mesh belt, either fed by gravity or aided by a slight vacuum, leaving the fibers behind. The pulp is further dried as it is pressed through felt rollers and then a series of steam-heated drying rollers; in this stage, the containerboard may also receive additions of starch or other surface coatings in the sizing press or presses, where the containerboard passes

through rollers continually fed with the desired chemicals. Remaining moisture and any additional moisture picked up in the sizing press is dried in the after-dryers, before the containerboard is slit to size and rolled for delivery to further processing plants, specifically the converting plants, which make corrugated boxes and other corrugated products.

Supporting Activities

Supporting activities include on-site steam and power production, on-site chemical production, effluent treatment, on-site residual management, etc.

4.2.5 Converting

The rolls of linerboard and corrugating medium (two different types of containerboard) are shipped to converting plants, where they are first assembled into a sheet that combines both the linerboard and the medium, and then converted into the corrugated product. This is achieved by softening the medium through a heat and steam treatment before receiving its distinctive fluted shape by being run through a pair of mating corrugated rollers. Starch is applied to the tips of the flutes and they are glued to the inner surface of one piece of linerboard. This initial board, with one layer of linerboard and one layer of corrugated medium (called singleface board), then passes on to the Double Backer, where starch is again applied and the flutes are glued to the second sheet of linerboard, making typical corrugated board (referred to as singlewall or doubleface). Further processing can add additional layers of corrugated medium and linerboard, building up double- or triple-walled board. The corrugated board is dried in the hot plate section, then slit into the required widths and cut into sheets, ready to be turned into boxes or other corrugated products. The final stages of processing (folding, gluing, and printing) are carried out and the finished products are stacked, palletized, and/or shipped.

As illustrated in Figure 14, three main types of converting facilities can be distinguished: corrugator plants, sheet feeder plants and sheet plants. The ratio of corrugated product from corrugator and sheet plants was provided by CPA (Fibre Box Association 2015).

Corrugator plants assemble linerboard and corrugating medium into corrugated sheets, and convert sheets into corrugated products (e.g., boxes) at the same location. Some corrugator plants also act as sheet feeder or sheet plants. Sheet feeder plants assemble linerboard and corrugating medium into corrugated sheets and ship them for final conversion into boxes or other corrugated products, mostly to sheet plants but also, in some cases, to corrugator plants. Sheet plants convert corrugated sheets produced mainly in sheet feeder plants, but also in some corrugator plants, into corrugated products. For confidentiality reasons, it is not possible to provide life cycle inventory data for the three types of converting plants individually. Instead, one aggregated dataset is presented for the whole converting in Table 20. Note, however, that the same approach was used to model the 2010 and 2014 converting plants. More information on the converting plants in 2010 can be found in the report of the original study. Converting was modeled identically for both industry-average and 100%-recycled corrugated product.

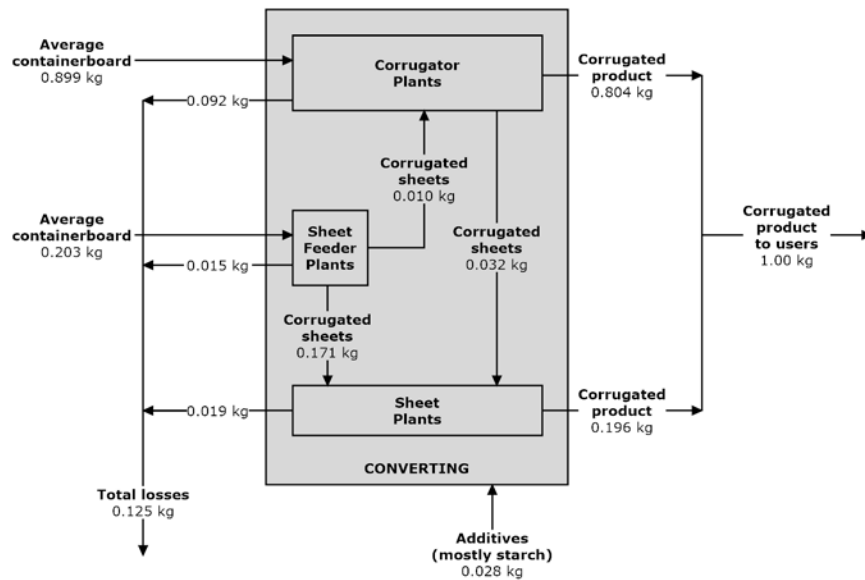

Figure 14. Overview of Converting Operations

[Note: Any differences between the figure above and the tables below are due to rounding.]

Table 20. Inputs/Outputs to Converting Unit Processes per Functional Unit (1.0 kg Corrugated Product)

Input/Output	Quantity	Unit ¹⁷	Comment
INPUTS			
Resources			
Water intake	0.457	kg	
Fiber Raw Material			
Containerboard	1.10	kg	
Chemicals			
Starch	2.00E-2	kg	
Wax	3.76E-3	kg	
Ink	1.30E-3	kg	
Adhesive	1.61E-3	kg	
Coating	5.13E-4	kg	
Borax	3.03E-4	kg	
Resin	3.38E-4	kg	
Caustic	5.51E-4	kg	
Energy			
Coal	0	MJ HHV	
Residual fuel oil (#5, 6)	0	MJ HHV	
Distillate fuel oil (#2)	0.150	MJ HHV	

(Table continued next page.)

¹⁷ All kg are dry kg.

Table 20. (Cont'd)

Input/Output	Quantity	Unit ¹⁸	Comment
Energy (cont'd)			
Gasoline and kerosene	8.91E-6	MJ HHV	Modeled as 100% gasoline.
Liquid propane gas	5.16E-2	MJ HHV	
Natural gas	1.20	MJ HHV	
Purchased power	0.142	kWh	
Purchased steam	2.41E-3	MJ	
OUTPUTS			
Products and co-products			
Corrugated product	1.0	kg	
Emissions to air			
Nitrogen oxides (NO _x)	5.09E-5	kg	
Sulfur oxides (SO _x)	1.03E-6	kg	
Particulates	4.37E-5	kg	
Carbon monoxide (CO)	5.44E-5	kg	
Carbon dioxide (CO ₂), fossil	8.51E-2	kg	
Methane (CH ₄), fossil	1.46E-6	kg	
Nitrous oxide (N ₂ O)	2.37E-7	kg	
Non-methane VOCs	1.39E-4	kg	
OUTPUTS			
Emissions to air			
Evaporated water	0.215	kg	Estimated by mass balances
Other toxics	As defined by the U.S. Toxics Release Inventory, estimated using U.S LCI data (NREL 2012)		
Emissions to water (direct releases refer to those directly released from converting facilities, while indirect means that it went through a third party).			
Effluent, direct	0.0133	kg	
Effluent, indirect and other	0.252	kg	
BOD, direct	4.53E-6	kg	
TSS, direct	2.52E-6	kg	
Residuals			
<i>Note: Landfill and burning were assumed to occur onsite. Land application and other beneficial uses were assumed to occur offsite.</i>			
Converting losses to recycling	0.125	kg	
Other solid waste	3.42E-3	kg	Only transportation of this waste stream was included in the LCA.

4.2.6 Use

The “use” life cycle stage includes the use of the corrugated products by various consumers. Because most environmental impacts arising during this life cycle stage would be allocated to the

¹⁸ All kg are dry kg.

content of corrugated packaging, vs. the packaging itself, use-related impacts associated with the corrugated product were considered to be negligible, and thus are not included in the system boundary. This assumption was also made for the 2006 and 2010 studies. Transportation to the use phase is included in the system boundary. Carbon storage in use is also considered where applicable.

4.2.7 End-of-Life and Recovery

4.2.7.1 *EoL Split*

End-of-life of the corrugated product was modeled according to the most recent U.S. average statistics (2016a, Table 5):

- Recycled: 89.5%;
- Combusted with energy recovery: 2.0%; and
- Landfilled: 8.5%.

The EoL was modeled the same way for the industry-average and 100%-recycled products.

4.2.7.2 *Modeling Considerations*

Landfill and incineration of OCC were modeled using secondary data that were modified to account for the actual carbon content of OCC considered in this study. In addition, the carbon balance around landfills was also modified to account for U.S.-specific conditions.

In landfills, a fraction of the biogenic carbon in forest products decays, primarily into gas. The remaining fraction, which varies by type of product, is non-degradable under anaerobic conditions. The degradable fraction of the biogenic carbon in landfills was assumed to decay according to a first-order equation as presented in Table 21. Under anaerobic conditions, about one-half of the carbon is converted to biogenic CO₂ while the other half is converted to CH₄. Under aerobic conditions (e.g., in shallow unmanaged landfills) a much smaller fraction of the gas consists of CH₄. A methane correction factor, provided in Table 21, was used to adjust methane generation to reflect the extent of anaerobic conditions in different types of landfills.

Another important factor influencing the releases of landfill CO₂ and methane (CH₄) to the atmosphere is the extent to which CH₄ is oxidized to biogenic CO₂ before exiting the landfill. Even in the absence of systems designed to capture and destroy methane, about 10% of the methane is oxidized as it moves through the surface layers of the landfill. Finally, some landfills are equipped with cover systems to collect and destroy methane by burning, and assumptions need to be made regarding the fraction of the methane that is collected and burned.

Landfill parameters used in this study are presented in Table 21.

Table 21. Parameters for Calculating Carbon Emissions from Landfilling of OCC

Parameter Analyzed	Value analyzed			Source(s)
	2014	2010	2006	
Biogenic carbon content (CC)	49.1%	49.5%	49.2%	Calculated.
Non-degradable carbon under anaerobic conditions (F_{CCND})	55%	55%	55%	Wang et al. (2011)
Methane correction factor (MCF)	1	1	1	IPCC (2006b), methane correction factors set up to be representative of managed anaerobic conditions.
Fraction of methane oxidized in landfill covers (F_{CH4OX})	10%	10%	10%	IPCC (2006b)
Fraction of methane burned (F_{CH4CB})	53%	53%	53%	(U.S. EPA 2016b)

Cumulative quantities of carbon dioxide and methane emitted are calculated as follows.

Quantity of Carbon Converted to Gas at a Given Time:

$$Q_{C \rightarrow Gas} = Q_{CP} \times MCF \times CC \times (1 - F_{CCND})$$

Where Q_{CP} is the quantity of corrugated products sent to landfill.

Quantity of Carbon Converted to Methane ($Q_{C \rightarrow CH_4}$):

$$Q_{C \rightarrow CH_4} = Q_{C \rightarrow Gas} \times 0.5$$

Quantity of Methane Not Collected and Burned (Q_{CH_4NCB})

$$Q_{CH_4NCB} = Q_{C \rightarrow CH_4} \times (1 - F_{CH_4CB})$$

Quantity of Methane Released to the Environment ($Q_{CH_4, Landfill}$):

$$Q_{CH_4, Landfill} = Q_{CH_4NCB} \times (1 - F_{CH_4OX}) \times \frac{16}{12}$$

Quantity of Carbon Dioxide Released to the Environment ($Q_{CO_2, Landfill}$):

$$Q_{CO_2, Landfill} = \left(Q_{C \rightarrow Gas} - Q_{CH_4, landfill} \times \frac{12}{16} \right) \times \frac{44}{12}$$

4.2.8 Residuals Management

Management of the residues produced in the different life cycle stages, as well as their management mode, was discussed previously in Sections 3.5.2.3, 4.2.4.1 and 4.2.4.2 .

4.2.9 Transportation

Transportation distances were modeled using the 2012 Commodity Flow Survey (CFS) (U.S. Department of Transportation and U.S. Department of Commerce, 2015, Table 7) and the U.S. LCI database (NREL 2012), unless otherwise specified. More details are provided in Table 22. For data taken in the Commodity Flow Survey, multiple and unknown modes, as well as insignificant modes, were neglected. Data from the 2007 CFS (U.S. Department of Transportation and U.S. Department of Commerce & U.S. Department of Commerce, 2010) were used for 2006 and 2010. Reported distances are total traveled distances.

Table 22. Details of Transportation Modeling Assumptions

Material transported	Data source	Assumed transportation profile							
		Truck		Train		Boat, Barge		Boat, Ocean	
		%	km	%	km	%	km	%	km
Wood logs to pulp and paper mills	2007 CFS, SCTG#25	96.8	145	3.2	919	0	0	0	0
	2012 CFS, SCTG#25	98.4	159	1.6	1577	0	0	0	0
Wood chips to pulp and paper mills	2007 CFS, SCTG#26	95.2	259	4.8	1989	0	0	0	0
	2012 CFS, SCTG#26	94.5	299	5.5	1674	0	0	0	0
Recovered fiber to pulp and paper mills	2007 CFS, SCTG#41	87.8	201	11.0	589	1.2	824	0	0
	2012 CFS, SCTG#41	85.4	241	12.6	505	2.0	822	0	0
Pulp to pulp and paper mills	2007 CFS, SCTG#27	78.6	267	21.4	1347	0	0	0	0
	2012 CFS, SCTG#27	80.1	262	19.8	1511	0	0	0	0
Chemicals	2007 CFS, SCTG#20	59.5	208	31.3	1355	6.8	336	2.5	2020
	2012 CFS, SCTG#20	58.1	217	28.0	1333	12.8	674	1.0	2992
Containerboard to converting	2007 CFS, SCTG#27	78.6	267	21.4	1347	0	0	0	0
	2012 CFS, SCTG#27	80.1	262	19.8	1511	0	0	0	0
Corrugated sheets	2007 CFS, SCTG#27	78.6	267	21.4	1347	0	0	0	0
	2012 CFS, SCTG#27	80.1	262	19.8	1511	0	0	0	0
Corrugated product to use	2007 CFS, SCTG#28	98.1	238	1.9	1849	0	0	0	0
	2012 CFS, SCTG#28	95.7	283	4.3	2446				
Residuals to management and product to end-of life	2007 CFS, SCTG#41	87.8	201	11.0	589	1.2	824	0	0
	2012 CFS, SCTG#41	85.4	241	12.6	505	2.0	822	0	0
Purchased hogged fuel, other biomass	CORRIM (Johnson et al. 2012)	100	145	0	0	0	0	0	0
All other fuels	See U.S. LCI database								

While the SCTG#20 category is for basic chemicals only and the system modeled uses various chemicals with various transportation profiles, the category was used as a simplification. Basic chemicals represent most the chemical quantities used in the life cycle.

4.3 Calculation Procedures

The LCI and LCIA calculations were undertaken using the GaBi 7 software package (thinkstep 1992-2016).

4.4 Data Quality Assessment

Table 23 presents a qualitative assessment of the quality of the data used in this study (see Section 3.6 for a description of data quality requirements). As shown, most of the data used were of high quality. Where certain data of lesser quality were found to be significant to the results, they are discussed in the section on limitations of this study. In addition, representativeness was discussed in Section 3.2.

Table 23. Data Quality Assessment

Data required	Reliability	Temporal correlation	Geographical correlation	Technological correlation	Representativeness Data collection			Process review	Process completeness
	Score								
FOREGROUND SYSTEM – Containerboard production									
Material inputs	1-2	1	1	1	2			1	1
Air releases: Non-toxic	1-2	1	1	1	2			1	
Air releases: Toxic*	2	1	1	1	2	3	4-5	1	
Water releases, TN and TP	3	1	1	1	5			1	
Water releases: Non-toxic	1-2	1	1	1	2			1	
Water releases: Toxic	2	1	1	1	2	3	4-5	1	
Energy data	1-2	1	1	1	2			1	
Mill solid wastes and management	1-2	1	1	1	2			1	
Soil released	2	1	1	1	2	3	4-5	1	
Co-product quantity (e.g., turpentine)	4	1	1	1				1	
All data									
All data	1-2	1	1	1	4			1	1

(Table continued next page. See note at end of table.)

Table 23. (Cont'd)

Data required	Reliability	Temporal correlation	Geographical correlation	Technological correlation	Representativeness Data collection	Process review	Process completeness
	Score						
BACKGROUND SYSTEM							
Forest operations	2	1-2	1	1	3	1-2 3 4-5	3
Chip production	2	1-2	1		1 3	1-2 3 4-5	3
Chemical production	1-2 3 4-5	1-2 3	1-2 5	3	4-5	1-2 3 4-5	1-2 3 5
Electricity production	1-2	1	1	1	3	1-2 3 4-5	1-2 3 5
End-of-life, split	1	1	1	1	3	1-2 3 4-5	1-2 3 5
End-of-life, models	1-2	1	5	1	3	1-2 3 4-5	1-2 3 5
TRANSPORTATION							
Distances and modes	1-2	2	1	3	5	3	5
Transportation processes	1-2	2 3	1	5	5	3	5

NOTE: The data quality assessment presented in this table is based on a new method by U.S. EPA (Edelen and Ingwersen 2016). Although this method is more stringent than that applied in previous studies (Weidema et al. 2013), overall data quality is similar to that in prior years.

5. LIFE CYCLE IMPACT ASSESSMENT METHODS

5.1 General LCIA Methods

According to ISO 14044, the mandatory elements of LCIA include (1) the selection of impact categories, category indicators, and characterization models; (2) the assignment of LCI results to the selected impact categories (classification); and (3) the calculation of category indicator results (characterization). LCIA can also include optional elements (normalization, grouping, and weighting). The ISO 14047 Technical Report (ISO 2012a) provides a list of commonly-used impact categories: global warming, stratospheric ozone depletion, photo-oxidant formation, acidification, nitrification (eutrophication), human toxicity, ecotoxicity, depletion of abiotic resources, and depletion of biotic resources. ISO recognizes that this list is not exhaustive. Other categories may look at radiation, noise and odor, or land use¹⁹, but for these latter categories, no widely-accepted characterization methods are yet available.

As in the 2009 study (using 2006 data), this study used the TRACI LCIA method (Bare et al. 2003) for impact assessment and the CML method (Guinee et al. 2002) as a sensitivity analysis. The most recent versions of these methods, as implemented in GaBi, were used (i.e., TRACI 2.1 (2012) and CML 2001 updated in April 2015). The CML method was used only for those indicators that have an equivalent in TRACI. The TRACI and CML methods have their own lists of impact categories. Table 24 links TRACI and CML impact categories with those listed in the ISO 14047 Technical Report, indicating those considered in this study. Other methods were also used as appropriate. For instance, information of global warming potentials were derived from the Fifth Assessment Report (AR5) of IPCC (IPCC 2013, Table 8.A.1). Impacts on land use and biodiversity were not quantified as there is no consensus method suitable for forest management.

Additional results are also presented for indicators at the inventory level: primary energy demand (non-renewable and renewable) and water use and water consumption. Turbine and rainwater were not included within water use.

Because some of the impact factors have been updated since 2010, impact scores were recalculated for the three LCA study years in making the comparison.

The ISO 14044 Standard also requires that, for comparative assertions, the report include a statement as to whether international acceptance exists for the selected category indicators. The only international evaluation of existing category indicators can be found in the ILCD Handbook (European Commission - Joint Research Centre - Institute for Environment and Sustainability 2011) and is specific to the European context. Nonetheless, this document was used as the basis for evaluating the international acceptance of the category indicators used in this study, as presented in Table 25. The inventory indicators are not presented in this table.

No grouping, normalization or weighting were performed.

¹⁹ Land use impact assessment methodologies are still under development. Inventory numbers are difficult to interpret and, without accepted impact assessment methodologies, could easily be misused and/or misinterpreted. For these reasons, land use numbers are not presented in this report.

Table 24. Selected Methods for LCA Impact Categories

Impact categories proposed by ISO 14047	TRACI 2.1 (2012) method		CML 2001 method		Other Method	
	Indicator name	Indicator results (unit)	Indicator name	Indicator results (unit)	Indicator name	Indicator results (unit)
Climate change	TRACI indicator not used.		CML indicator not used.		Global warming* (IPCC 2013, Table 8.A.1)	kg CO ₂ eq. ²⁰
Stratospheric ozone depletion	Ozone depletion (1999 World Meteorological Organization, WMO, model)	kg CFC-11 eq.	N/A (same model implemented in TRACI and CML)		N/A	
Photo-oxidant formation	Smog	kg O ₃ eq.	Photochemical oxidation	kg C ₂ H ₄ eq.	N/A	
Acidification	Acidification (water and air)	kg SO ₂ eq.	Acidification	kg SO ₂ eq.	N/A	
Nitrification/Eutrophication	Eutrophication (water and air)	kg N eq.	Eutrophication (water and soil)	kg PO ₄ eq.	N/A	
Human toxicity†	Carcinogenics	CTUh	N/A.		N/A	
	Non carcinogenics	CTUh			N/A	
Ecotoxicity†	Ecotoxicity	CTUe			N/A	
					N/A	
					N/A	
Depletion of abiotic resources (e.g., fossil fuels, minerals)‡	Fossil fuel depletion	MJ surplus	The CML “abiotic resource depletion” indicator will not be included because there is no equivalent in TRACI. Factors for fossil fuel depletion were not used.		Primary energy demand (non-renewable, gross) - GaBi	MJ
Depletion of biotic resources (e.g., fish, wood)	No indicator is available in TRACI or in CML.			Primary energy demand (renewable, gross) - GaBi	MJ	
Land use impacts	Neither TRACI nor CML provides an indicator for land use. Impact assessment methodologies are still under development and inventory numbers are difficult to interpret without generally accepted impact assessment methodologies and could easily be misused					
Respiratory effects inorganics substances§	Respiratory effects	RE	kg PM2.5 eq.	N/A.		N/A

*In this report, "global warming" is used instead of "climate change". GWPs can be found here:

http://www.ipcc.ch/pdf/assessment-report/ar5/wg1/WG1AR5_Chapter08_FINAL.pdf. †Toxicity-related impact categories were excluded from the original study because of their inherent uncertainty. However, recently, the USEtox method, which represents a consensus amongst several life cycle impact assessment researchers, was published (Rosenbaum et al. 2008) and incorporated within TRACI. The results from applying this method are provided in Appendix I as a learning experience. ‡The primary energy demand (GaBi) evaluates the total energy requirements throughout the life cycle of the studied product. The fossil fuel depletion indicator (TRACI) accounts for the fact that continued extraction and production of fossil fuels tend to consume the most economically recoverable reserves first so that continued extraction will become more energy intensive in the future (Bare et al. 2003). The fossil fuel depletion indicator is an attempt to estimate the incremental energy requirements per unit of consumption of fuel in the future compared to today's conditions. §Mentioned in ISO 14047, but not described as commonly used.

²⁰ Equivalent.

Table 25. Evaluation of International Acceptance of the Category Indicators Used

Impact categories	Evaluation of international acceptance*
Global warming (GW)	There is a wide consensus on the use of IPCC's global warming potentials.
Ozone depletion (ODP)	There is a wide consensus on the uses of the World Meteorological Organisation's ozone depletion potentials that are implemented in all LCIA method.
Smog (POCP)	The ILCD Handbook makes the following evaluation of TRACI's smog indicator: <i>"weighted towards human health impacts (?). Fate model extensively reviewed, further components derived from reviewed information, no treatment of uncertainty in resulting CFs**. Method principles and CFs documented and accessible for app. 580 substances."</i>
Acidification (AP)	The ILCD Handbook makes the following evaluation of TRACI's acidification indicator: <i>"The method lacks of sufficient environmental relevance. It fully considers atmospheric fate, but not the soil sensitivity to acidifying deposition. It needs to be at least complemented by average soil fate factors distinguishing for sensitive and non-sensitive areas"</i> . The results obtained for the acidification indicator in this study where compared with those using CML that meets the ILCD Handbook science criteria. The use of one method versus the other did not affect the results significantly.
Eutrophication (EP)	The ILCD Handbook makes the following evaluation of TRACI's eutrophication indicator (aquatic only): <i>"Fate model well reviewed, but NH₃ not covered. Further components derived from reviewed information, some treatment of spatially determined uncertainty in resulting CFs. Method principles and CFs documented and accessible for all main contributing substances."</i> The CFs for the terrestrial eutrophication were published after the evaluation by the European Commission. Also, NH ₃ is now included in TRACI.
Human toxicity and ecotoxicity (HHC/ECO)	The USETox model is the LCIA method recommended by the ILCD Handbook in the European context. A U.S.-specific version of that method (in TRACI) was used. However, the ILCD Handbook specifies that it needs some improvement and should be used with caution. For this reason, the method was not used to perform any comparison.
Fossil fuel depletion (FF)	TRACI's FF impact category is based on EcoIndicator. The ILCD evaluation of the EcoIndicator resource depletion indicator is as follows: <i>"Relatively simple model, based on estimated slope factors. Combination with fossil fuels somewhat problematic."</i> The use of fossil fuels was also characterized using a non-renewable primary energy inventory indicator that generally led to similar conclusions.
Respiratory effects (RES)	TRACI method for respiratory effects was described as <i>"good science based"</i> by the ILCD Handbook.

*Note: The evaluation of the ILCD Handbook was based on a previous version of the TRACI method but is still mostly applicable. **CFs: Characterization factors.

5.2 Accounting Practices for Biogenic Greenhouse Gases and Land Use Change

5.2.1 Flow and Stock Change Accounting for Biogenic CO₂

In accordance with accepted greenhouse gas accounting practices, biomass-derived CO₂ was tracked separately from fossil fuel-derived CO₂ and other greenhouse gases in the life cycle inventory. There are two main approaches for biogenic carbon accounting (IPCC 2006a, NCASI 2013b): flow accounting and stock change accounting.

Although typically not referred to using this terminology in LCA studies, **flow accounting** is the approach most commonly used in LCA. This approach consists of characterizing the effects of biomass carbon on the atmosphere by calculating the net emissions of biogenic CO₂ (emissions

minus removals) occurring in the product system, which are then added to the global warming results. This approach was used in the previous studies and is also used in this study. In applying this approach, the same GWP was applied to methane releases from biogenic and fossil sources to avoid double counting the removal.²¹

Stock change accounting is typically used in national inventories. This approach characterizes the effects of biomass carbon on global warming by calculating the changes in the stocks of stored carbon through the life cycle of the product. An increase in stocks is beneficial for the global warming indicator and a decrease in stocks is detrimental for the global warming indicator.

In systems where there are no flows of stored biogenic carbon (e.g. carbon in wood fiber) across system boundaries, the net change in total stocks of stored biomass carbon is mathematically equal to the net flow of biomass carbon to/from the atmosphere, i.e., what is stored is not released. Flows of stored biomass carbon across system boundaries are mostly related to recycling. Indeed, for all products in this study there is a net export of old corrugated containers to other product systems. As a consequence of that export, the calculated global warming impact from biomass carbon depends on the accounting approach used (see Figure 47 and Figure 48 in Appendix B for cradle-to-grave schematics of carbon flows and stocks). Because of the potential differences in global warming results caused by the accounting approach, it was decided to present the stock change results as a sensitivity analysis. In using this approach, a GWP for biogenic methane lower than that from fossil sources was applied, as recommended by IPCC.

Another approach sometimes used in LCA is simply ignoring biogenic CO₂ when calculating the global warming indicator results (see examples in NCASI 2011) to obtain an understanding of how non-biogenic CO₂ GHG contribute to the global warming indicator. Note that this approach ignores any removal/storage of biogenic carbon.

²¹ IPCC (2013, Table 8.A.1) proposes two different GWPs for methane: one for fossil (30 kg CO₂ eq./kg) and one for biogenic (28 kg CO₂ eq./kg). However, as highlighted by IPCC, caution to avoid any double-counting is needed in applying these potentials. When applying the flow accounting method, CO₂ taken up by the biosphere then released into methane is already accounted for by the removal.

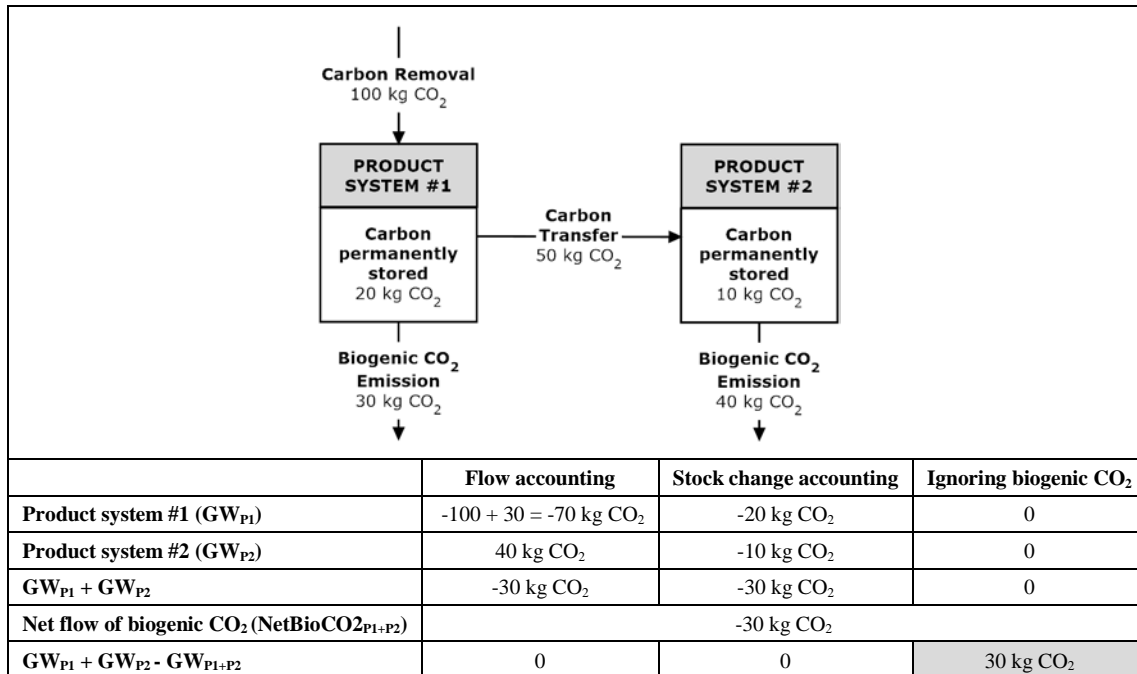

Figure 15. Illustration of Various Biogenic Carbon Accounting Methods

(Note: The example in the figure above applies a cut-off allocation method for recycling, meaning that the environmental load is applied where it occurs. However, the approach is equally valid for other allocation method for recycling. For instance, if one was to apply the flow accounting method to biogenic carbon and the number of uses method for recycling, a fraction of the net biogenic carbon flow in Product System #1 (i.e., -100 + 30) would have been transferred to Product System #2. Similarly, if the stock change accounting method was used, a fraction of the fraction permanently stored in Product System #1 (20) would have been transferred to Product System #2 if the number of uses method was applied.

5.2.2 Change in Stocks Potentially Occurring in a Forest Product Life Cycle

Understanding where stock changes occur in the life cycle of a forest product is necessary for using stock change accounting and is useful in interpreting biogenic CO₂ emissions information generated by both stock change and flow accounting. There are three main places where a change in carbon stocks can occur in a forest product life cycle: in the forest, in use, and in landfills. These are discussed in greater detail next.

5.2.2.1 Forest Carbon Stocks

Where forests are managed to produce a sustained yield of fiber, changes in forest carbon stocks mostly occur through land use changes (e.g., through forest conversion to a different land use), although forest carbon stocks can increase or decrease without changing the land use type (e.g., where high-carbon stock forests are converted to intensively-managed forests).

Capturing impacts of land use change or change in forest carbon stocks on GHGs in LCA studies is always challenging, especially when performing an assessment at the scale of the entire industry. Data do not exist that would allow a detailed assessment of the impacts of each containerboard mill on forest carbon stocks. We are left, therefore, with having to assess potential impacts at a larger scale. The WRI/WBCSD Product Standard suggests just such an

approach when the specific land supplying wood cannot be identified (WRI and WBCSD 2011b).

A report by U.S. EPA shows that forest area and related carbon stocks in the U.S. are stable to increasing between 1990 and 2014 (U.S. EPA 2016b, Table 6-12). This finding is conceptually consistent with adherence to sustainable forest management certification principles (a requirement of AF&PA membership), which require regeneration of the forest to meet future needs for wood. With forest carbon stocks stable or increasing, it follows that the carbon being removed from these forests by harvesting, fires and other means is being offset (or more) by growth in the forest, representing net flows of carbon into the forest from the atmosphere. These observations are used to support assumptions about the flows of CO₂ into forests that provide wood to the containerboard sector (i.e., it is assumed that the carbon in the wood removed for containerboard is equal to the carbon removed from the atmosphere by that system).

Furthermore, several studies (e.g., Abt et al. 2012, Daigneault et al. 2012) have shown that where forest is being lost it is not due to use of the land for wood production. Indeed, research demonstrates that the market for wood in the U.S. helps avoid conversion of forest to other non-forest uses (e.g., Galik and Abt 2012, Hardie et al. 2000, Lubowski et al. 2008).

Therefore, based on empirical evidence of (a) stable (or increasing) forest carbon stocks, (b) increasing forested area, and (c) research demonstrating that the demand for wood helps counteract deforestation, it was assumed that there was no change in forest carbon stocks attributable to wood harvested to make containerboard. In addition, although the carbon stocks are slightly increasing, no credits for these additional removals were considered in this study.

5.2.2.2 In Use Carbon Stocks

When forest products remain in circulation for a long period, for instance more than 100 years, this is sometimes considered as an increase in carbon stocks (Miner 2006). In this study, an infinite period of time was selected as a temporal boundary; hence, no storage of carbon in products in use was considered. The potential effect of this choice on the results was evaluated by calculating the amounts of biomass carbon in products in use expected to remain out of the atmosphere for at least 100 years (as this represents a long-term net removal of carbon from the atmosphere).

5.2.2.3 Landfill Carbon Stocks

When products are sent to landfill a fraction of their carbon is non-degradable and hence the stocks of carbon in landfills are increasing. Additions to carbon stocks in landfills were assumed to be equal to the amount of biomass carbon in the product that is non-degradable under anaerobic conditions, the same assumption as made by U.S. EPA (2014). The modeling details for landfills can be found in Section 4.2.7.2.

5.2.3 Biogenic CH₄ and N₂O

In this study, IPCC AR5 GWPs were used to calculate the global warming indicator results (IPCC 2013, Table 8.A.1). As required by IPCC and other major greenhouse gas accounting protocols (WRI and WBCSD 2004), where methane or nitrous oxide are formed in biomass

combustion these were included in fossil fuel-derived greenhouse gas totals and the IPCC AR5 factors were applied.

5.2.4 Summary of Biogenic GHG Approach

In summary, for calculating the global warming indicator results, IPCC AR5 global warming potentials and flow accounting were used. Using that approach, the global warming results were calculated as follows:

$$GW, F = GW_{FF} + (E_{BioCO_2} - R_{BioCO_2}) \times 1 + CH_{4,Bio} \times 30 + N_2O_{Bio} \times 265 + E_{FC}$$

Where GW, F is the global warming results calculated using flow accounting for biogenic CO_2 (in kg CO_2 eq.); E_{BioCO_2} , the emissions of biogenic CO_2 (in kg); R_{BioCO_2} , the removals (in kg); $CH_{4,Bio}$, the methane emissions from biomass (in kg); N_2O_{Bio} , the emissions of nitrous oxide (in kg); 1, 30, and 265 the GWPs for CO_2 , CH_4 and N_2O (in kg CO_2 eq./kg); and E_{FC} , the emissions due to change in forest carbon stocks (in kg CO_2 eq.). E_{FC} was assumed to be 0.

Stock change accounting was used as a sensitivity analysis. Using that approach, the global warming results were calculated as follows:

$$GW, S = GW_{FF} + CH_{4,Bio} \times 28 + N_2O_{Bio} \times 265 - S_1 - S_2 - S_3$$

Where GW, S is the global warming results calculated using stock change accounting for biogenic CO_2 (in kg CO_2 eq.); S_1 , the change in forest carbon stocks (in kg CO_2 eq.); S_2 , the change in "in use" stocks (in kg CO_2 eq.) and S_3 , the change in landfill stocks (in kg CO_2 eq.). S_1 and S_2 were assumed to be 0.

More details regarding flows of biogenic carbon in the product systems analyzed can be found in Appendix B.

6. RESULTS AND INTERPRETATION: 2014 LCA

6.1 LCIA and Additional Indicator Results

This section presents the results for the impact categories and inventory indicators specified above. All these results, unless otherwise specified, are based on the 2014 actual dataset. Note that LCIA results are relative expressions and do not predict impacts on category endpoints, the exceeding of thresholds, safety margins or risks. LCIA indicator results are presented in Table 26 and inventory indicators in Table 27. More details are presented in subsequent sections of this report. Toxicity indicator results are presented in Appendix I.

Table 26. LCIA Indicator Results per Functional Unit (Industry-Average)

Impact categories proposed by ISO 14047	Nomenclature	TRACI method	CML method	IPCC AR5 GWPs
Global warming				
Flow accounting	GW,F			0.532 kg CO ₂ eq.
<i>Stock change accounting (sensitivity analysis)</i>	GW,S			1.44 kg CO ₂ eq.
<i>Excluding biogenic CO₂ (sensitivity analysis)</i>	GW,Excl. BioCO ₂			1.56 kg CO ₂ eq.
Stratospheric ozone depletion	ODP	6.89E-8 kg CFC-11 eq.		
Photo-oxidant formation	POCP	0.122 kg O ₃ eq.	1.36E-3 kg C ₂ H ₄ eq.	
Acidification	AP	0.0119 kg SO ₂ eq.*	0.0127 kg SO ₂ eq.	
Nitrification/ Eutrophication	EP	9.46E-4 kg N eq.*	1.07E-3 kg PO ₄ eq.	
Depletion of abiotic resources (e.g., fossil fuels, minerals)	FF	1.73 MJ surplus		
Respiratory effects inorganics	RES	11.23E-3 kg PM _{2.5} eq.		

*Total of air and water.

Table 27. LCI Indicator Results per Functional Unit (Industry-Average)

Additional indicator	Nomenclature	Results
Non-renewable primary energy demand	NRPE	18.5
Renewable primary energy demand	RPE	9.60
Water use	WU	41.9
Water consumption	WC	13.1

6.2 Identification of Significant Issues

According to the ISO 14044 Standard, the objective of "identification of significant issues" element of a LCA is to structure the results from the LCI or LCIA phases to determine what is important to the result. Different methods exist to identify significant issues; contribution analyses are the most commonly used. In contribution analyses, the contribution of life cycle stages or groups of unit processes to the total result is examined. In addition, the contribution of individual inventory parameters to different impact categories can also be analyzed.

Contribution analyses are presented in Figure 16, Figure 17 and Figure 18. These figures show that the pulp and papermaking operations life cycle stage, which includes forestry operations, is the main contributor to all indicators except global warming, to which it contributes negatively (i.e., accomplishes net removals of CO₂ from the atmosphere), and water consumption. The converting life cycle stage is a significant contributor to all indicators. End-of-life is relevant only for the global warming indicator.

Results depicted in Figure 18 also shows that the choice of method for calculating the various indicators greatly has little effect in terms of how each life-cycle stage contributes to the various impacts.

Each indicator is discussed in greater detail below, with a focus on the global warming indicator. Although the CML method was applied only as a sensitivity analysis, the results of applying this method are discussed directly for each indicator where applicable instead of in the sensitivity analysis section of the report.

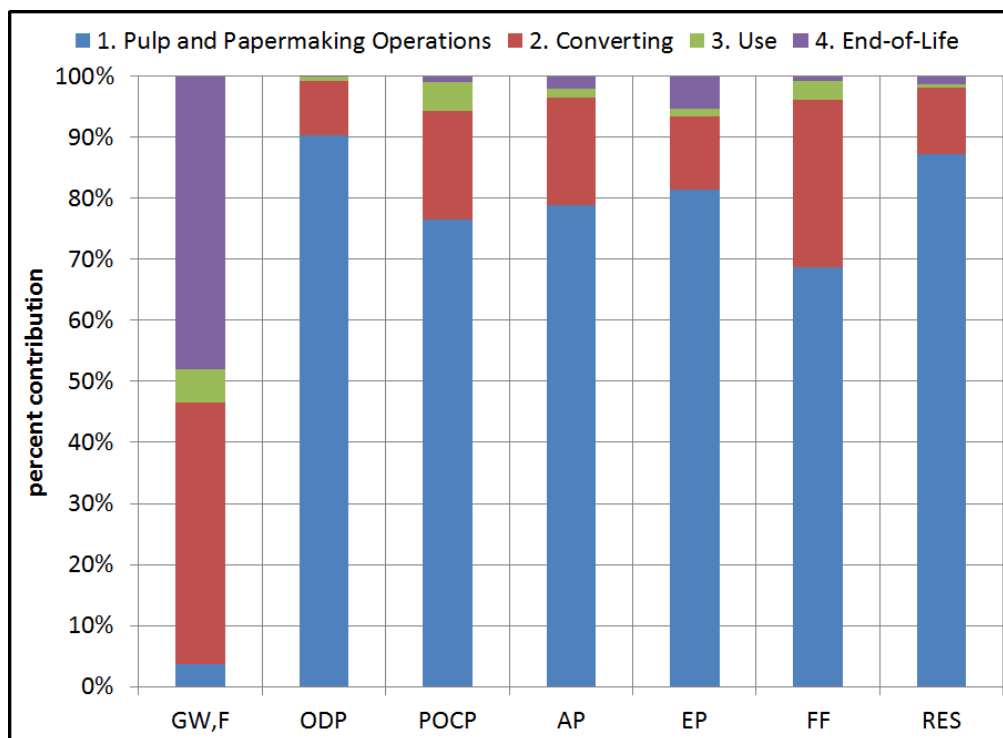

Figure 16. Contribution Analyses for LCIA Indicators, TRACI and IPCC (Industry-Average)

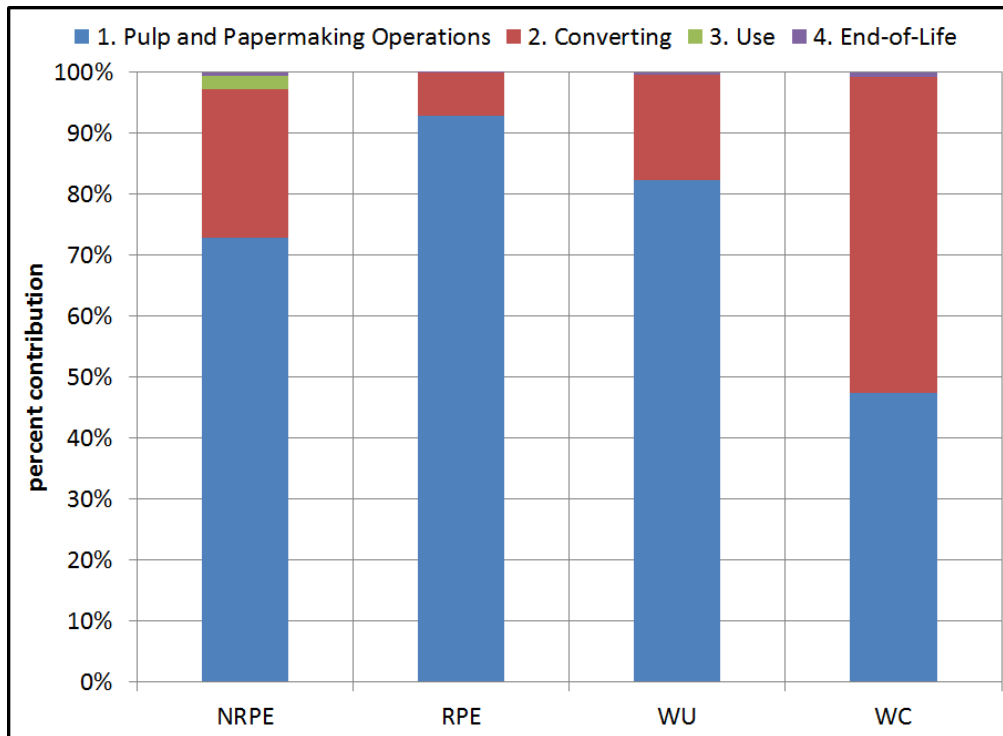

Figure 17. Contribution Analyses for LCI Indicators, GaBi and Inventory (Industry-Average)

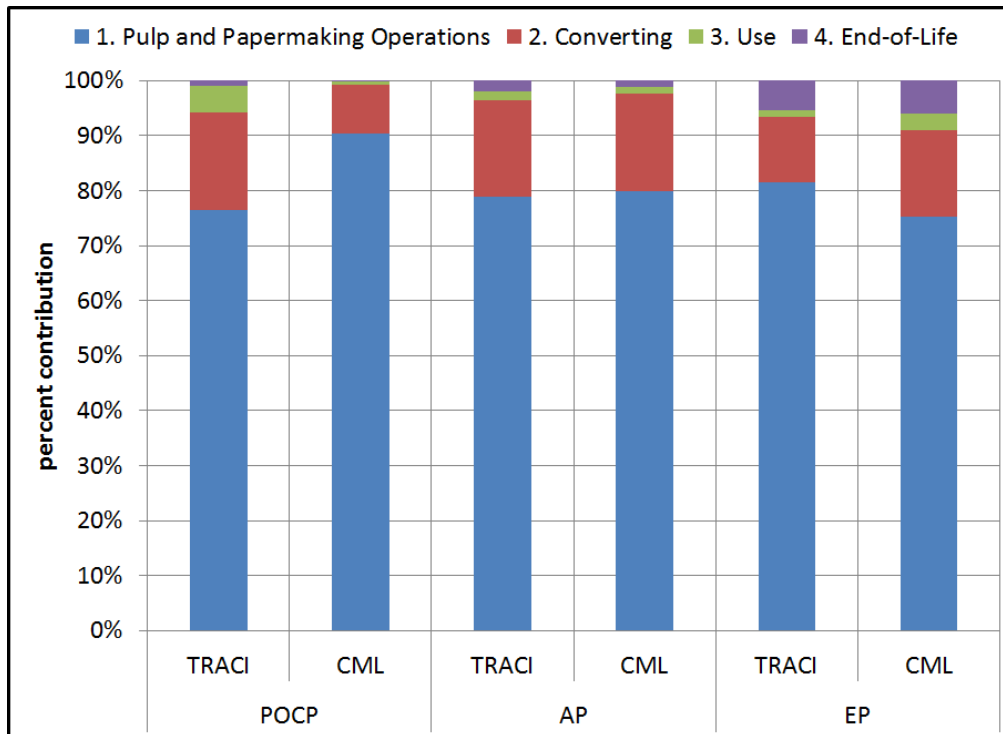

Figure 18. Contribution Analyses for LCIA Indicators, CML Method (Industry-Average)

6.2.1 Global Warming

This section presents more details on the global warming indicator.

Figure 19 presents the global warming indicator using different approaches for biogenic CO₂. It shows that the flow accounting method gives lower results than the stock accounting method and excluding biogenic CO₂. This is because there is a significant amount of carbon removed from the atmosphere (negative emission of GHG) that is accounted for using the flow accounting method. This also explains why the pulp and paper making operations life cycle stages show little contribution to the global warming indicator using the flow accounting method. Indeed, using this method, removals of carbon that occur within the life cycle stage (tree growing in the forest) are enough to offset other emissions from this life cycle stage.

Figure 19 also shows that the reported value for the stock change accounting method are lower than when totally ignoring biogenic CO₂. This is explained by the fact that some biogenic carbon is stored (negative emission) within the system boundaries of the product investigated and this is accounted for using the stock change accounting method but not when ignoring biogenic CO₂.

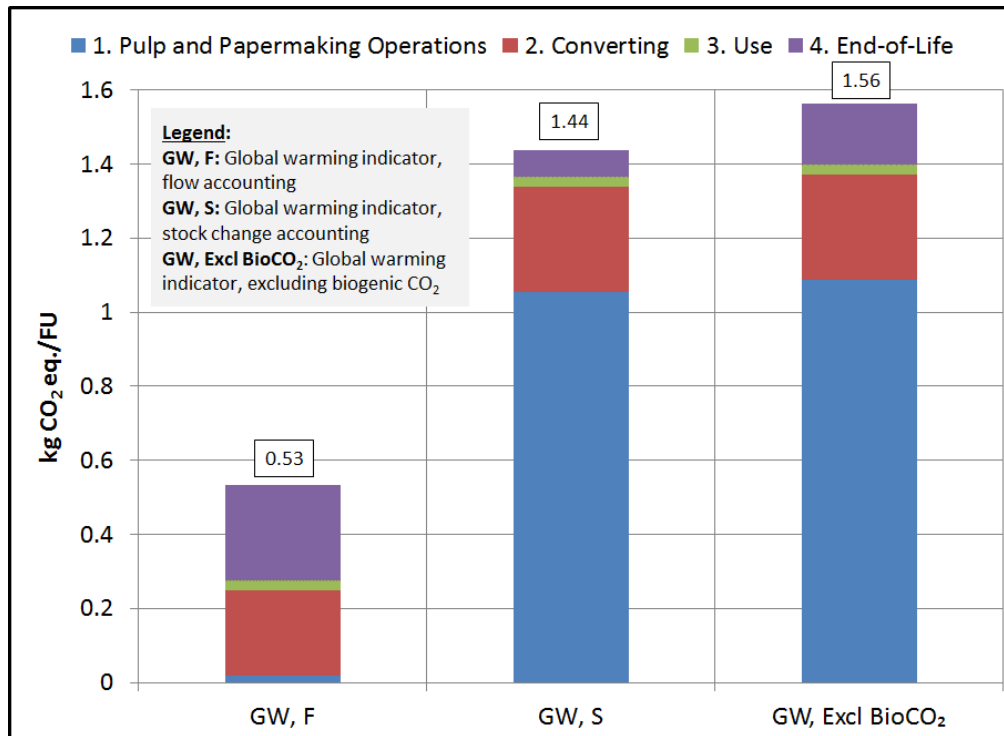

Figure 19. Global Warming Results

Table 28 details the contribution of the life cycle stages and some groups of unit processes to each of the GHGs that contributes towards the global warming indicator (flow accounting method). Figure 20 presents visually how each life cycle stage contributes to the individual GHGs and drills down into the pulp and papermaking operations and converting life cycle stages.

The following can be observed from Table 28 and Figure 20a.

- Removals (primarily due to biomass grown to produce containerboard) offset a large proportion of all GHGs (biogenic CO₂ and other GHGs).
- Emissions of biogenic CO₂ occur mainly at in the pulp and papermaking operations life-cycle stage.
- Emissions of other GHGs are distributed across the pulp and papermaking operations, converting and end-of-life life cycle stages.
- Overall the main contributors to the total global warming indicator are end-of-life and converting.

Figure 20b shows that, within the pulp and papermaking operations life cycle stage, forest operations are responsible for most removals while energy production is mainly responsible for biogenic CO₂ and other GHG emissions. The remaining life cycle stages, for instance chemical production and residual management, do not contribute significantly to the global warming indicator. Figure 20c presents the contributions of various energy sources to the individual GHG and total global warming indicator results. Biofuels such as spent liquor and hogged fuel are the only significant contributors to biogenic CO₂. Note that in Figure 20c, only a small portion of the removals is depicted. This is because the removals associated with spent liquor and self-generated hogged fuel are accounted for with the fiber input. Other GHGs are distributed across various energy sources including, in order of contribution, purchased power, natural gas, coal, and purchased steam. Figure 20d focuses on converting. From this figure, the following can be observed:

- Chemicals (starch) are responsible for the removals.
- There are very low emissions of biogenic CO₂ because converting facilities do not typically use biomass fuels.
- Other GHGs are spread across energy (mainly purchased electricity and natural gas), transportation of the containerboard to converting facilities, and chemicals (mainly starch and ink), with energy being the main contributor to the total global warming impact score.

Table 28. Contribution of the Various Life Cycle Stages/Groups of Unit Processes to the Global Warming Results by Type of Gases (Industry-Average)

Life cycle stage/Unit process	Removals	Biogenic CO ₂ emissions	Other GHGs emissions	Total
	kg CO ₂ eq./FU			
1. Pulp and papermaking operations	-2.33	1.26	1.09	0.019
Fiber	-2.05	0.00	0.10	-1.95
Energy	-0.26	1.23	0.85	1.81
Rest	-0.01	0.03	0.13	0.16
2. Converting	-0.06	0.01	0.28	0.23
Energy	0.00	0.00	0.19	0.19
Chemicals	-0.06	0.00	0.05	-0.01
Transportation of containerboard	0.00	0.00	0.03	0.03
Rest	0.00	0.00	0.01	0.01
3. Use	0.00	0.03	0.00	0.03
4. End-of-Life	0.00	0.09	0.16	0.26
Total	-2.39	1.39	1.54	0.53

NOTE: In this table, the main individual contributors are displayed in yellow.

Appendix I presents the results according to the scopes of the GHG Protocol.

6. Result and Interpretation: 2014 LCA

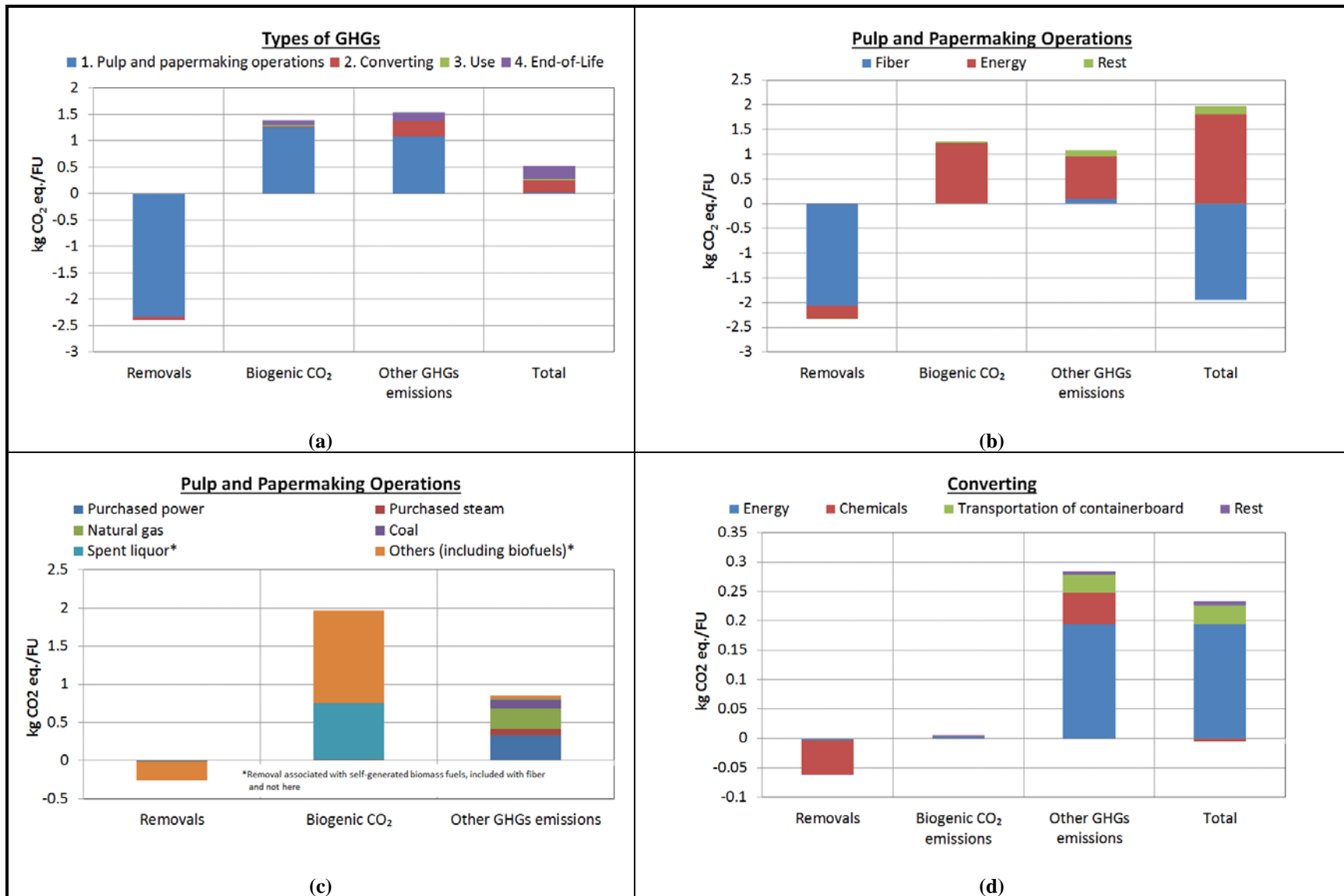

Figure 20. Detailed Contribution Analyses for the Global Warming Indicator a) Type of Gases b) Pulp and Papermaking Operations, c) Energy used at Pulp and Papermaking Operations, and d) Converting (Industry-Average)

6.2.2 Ozone Depletion

Table 29 details the contribution of the life cycle stages and some groups of unit processes to each substance that contributes towards the ozone depletion indicator. In this table, the five main contributors are highlighted in yellow. It can be seen that energy used at pulp and paper mills is the main contributor. More specifically:

- chloromethane is mostly released through spent liquor combustion at pulp and paper mills;
- methyl bromide and 1,1,1-trichloroethane are mostly released through wood combustion at pulp and paper mills; and
- halon 1211 is mostly released through natural gas combustion both at pulp and paper and power plants.

Table 29. Contribution of the Various Life Cycle Stages/Groups of Unit Processes to the Ozone Depletion Results by Substances (Industry-Average)

Life cycle stage/ Unit process	Chloromethane	Methyl Bromide	Halon 1211	1,1,1- trichloroethane	Others	Total
Total	6.1%	30.9%	35.0%	25.4%	2.6%	100%
1. Pulp and papermaking operations	6.1%	30.9%	26.1%	25.4%	1.8%	90.3%
Fiber	0.3%	0.0%	2.2%	0.0%	0.3%	2.8%
Energy	5.8%	30.8%	23.0%	22.3%	1.3%	83.2%
Process emissions and others	0.0%	0.1%	0.8%	3.1%	0.1%	4.2%
2. Converting	0.0%	0.0%	8.2%	0.0%	0.7%	8.9%
3. Use	0.0%	0.0%	0.7%	0.0%	0.0%	0.7%
4. End-of-Life	0.0%	0.0%	0.0%	0.0%	0.1%	0.1%

NOTE: In this table, the main individual contributors are displayed in yellow.

6.2.3 Photo-Oxidant Formation (Smog)

Table 30 shows that, using the TRACI method, NO_x is the main substance relevant to the smog indicator, with the pulp and papermaking operations as its main contributor. The main processes contributing to NO_x are highlighted in yellow. Various forms of energy used at pulp and paper mills, including wood fuels, coal or purchased power, cause a significant portion of NO_x emissions. Fiber transportation to pulp and paper mills is also an important contributor. On the converting side, transportation of board to converting mills, purchased electricity and starch production are the main emitters of smog-related substances.

The CML method identifies much less importance related to NO_x in characterizing the smog indicator. Indeed, its contribution is only 9.76%. Other substances contributing include:

- sulfur dioxide (28.1%, not characterized under smog in TRACI);
- NMVOC (50.8%); and
- others (11.3%).

The contribution of the various life cycle stages is similar when using TRACI and CML.

Table 30. Contribution of the Various Life Cycle Stages/Groups of Unit Processes to the Smog Results by Substances, TRACI Method (Industry-Average)

Life cycle stage/Unit process	NO _x	NMVOG	Others	Total
Total	94.8%	4.6%	0.6%	100%
1. Pulp and papermaking operations	72.4%	3.5%	0.3%	76.2%
Fiber	16.8%	0.2%	0.0%	17.0%
Energy	43.5%	2.6%	0.3%	46.4%
Process emissions and others	12.1%	0.7%	0.0%	12.8%
2. Converting	16.6%	0.9%	0.2%	17.6%
3. Use	4.8%	0.0%	0.0%	4.8%
4. End-of-Life	1.1%	0.1%	0.1%	1.3%

NOTE: In this table, the main individual contributors are displayed in yellow.

6.2.4 Acidification

Table 31 shows that, using the TRACI method, SO₂ and NO_x are the main substances for the acidification indicator, with the pulp and papermaking operations as their main contributor. More specifically:

- emissions of SO₂ from the pulp and papermaking operations life cycle stage arise mainly from purchased power, burned natural gas and burned coal;
- emissions of NO_x from the pulp and papermaking operations life cycle stage are mainly due to wood combustion and purchased power; and
- natural gas used at converting facilities and production of purchased power used by converting facilities are significant contributors to SO₂ emissions.

The CML method gives slightly more importance to SO₂ (74.9%) compared to NO_x (19.1%) than TRACI. This has little effect on the relative contribution of the life cycle stages.

Table 31. Contribution of the Various Life Cycle Stages/Groups of Unit Processes to the Acidification Results by Substances, TRACI Method (Industry-Average)

Life cycle stage/Unit process	NO _x	SO ₂	Others	Total
Total	27.6%	64.3%	8.1%	100%
1. Pulp and papermaking operations	21.1%	52.3%	5.5%	78.9%
Fiber	4.9%	1.4%	0.1%	6.4%
Energy	12.7%	47.6%	2.8%	63.1%
Process emissions and others	3.5%	3.3%	2.6%	9.4%
2. Converting	4.8%	11.8%	0.9%	17.5%
3. Use	1.4%	0.1%	0.0%	1.5%
4. End-of-Life	0.3%	0.1%	1.7%	2.0%

NOTE: In this table, the main individual contributors are displayed in yellow.

6.2.5 Eutrophication

Table 32 shows that, using the TRACI method, NO_x, total nitrogen released to water, total phosphorus released to water and a mix of other substances (mostly BOD and COD) contribute the most to eutrophication. Contributors to NO_x were discussed previously for the acidification indicator. Releases of total nitrogen, total phosphorus, and BOD are mostly attributable to pulp and paper mills. Note that the emissions of nitrogen and phosphorus from pulp and paper mills were modeled and are highly uncertain.

Table 32. Contribution of the Various Life Cycle Stages/Groups of Unit Processes to the Eutrophication Results by Substances, TRACI Method (Industry-Average)

Life cycle stage/Unit process	NO _x	Total N (water)	Total P (water)	Others	Total
Total	21.9%	25.6%	5.4%	47.0%	100%
1. Pulp and papermaking operations	16.7%	22.8%	3.0%	38.9%	81.5%
Fiber	3.9%	0.0%	1.0%	0.7%	5.6%
Energy	10.1%	0.3%	1.3%	5.7%	17.3%
Process emissions	2.4%	21.2%	26.9%	5.1%	55.5%
Rest	0.4%	1.4%	0.8%	0.5%	3.1%
2. Converting	3.8%	2.8%	2.4%	3.3%	12.3%
3. Use	1.1%	0.0%	0.0%	0.1%	1.2%
4. End-of-Life	0.3%	0.0%	0.0%	4.7%	5.0%

NOTE: In this table, the main individual contributors are displayed in yellow.

CML gives much more importance to nitrogen oxides compared to nitrogen and phosphorus than TRACI for the eutrophication impact category. More specifically, the contributions of the various substances are as follows:

- NO_x: 53.4%;
- phosphorus to water: 10.0%;
- nitrogen to water: 11.3%;
- BOD/COD: 3.6%; and
- others: 21.7%.

This means that, when using the CML impact assessment method, process emissions are not an important contributor to eutrophication.

6.2.6 Respiratory Effects (Human Health Particulates)

As expected, results presented in Table 33 show that particulates and SO₂ are the main substances of concern related to respiratory effects. Processes contributing to SO₂ have been discussed previously. The energy used at pulp and paper mills, and more specifically the combustion of biofuel and coal, are the main contributors to particulate emissions.

Table 33. Contribution of the Various Life Cycle Stages/Groups of Unit Processes to the Respiratory Effects Results by Substances, TRACI Method (Industry-Average)

Life cycle stage/Unit process	SO ₂	Particulates	Others	Total
Total	38.0%	58.3%	3.7%	100%
1. Pulp and papermaking operations	30.9%	53.7%	2.5%	87.1%
Fiber	0.9%	5.1%	0.5%	6.4%
Energy	28.1%	47.9%	1.7%	77.7%
Rest	2.0%	0.7%	0.4%	3.0%
2. Converting	7.0%	3.3%	0.7%	11.0%
3. Use	0.1%	0.4%	0.1%	0.6%
4. End-of-Life	0.1%	0.9%	0.3%	1.3%

NOTE: In this table, the main individual contributors are displayed in yellow.

6.2.7 Fossil Fuel Usage

Two different indicators were studied concerning fossil fuel usage:

- TRACI's **fossil fuel depletion** (FF) indicator that accounts for the fact that continued extraction and production of fossil fuels tend to consume the most economically recoverable reserves first so that continued extraction will become more energy intensive in the future; and
- GaBi's **non-renewable primary energy** (NRPE) demand that evaluates the total non-renewable energy requirements throughout the life cycle of the studied product.

These two indicators provide different information; hence, were both studied.

Table 34 shows that natural gas and crude oil are the fuels that contribute the most towards the fossil fuel depletion indicator. The following operations consume the most natural gas: pulp and paper mills, converting facilities, and power production for both pulp and paper mills and converting facilities. Crude oil is mainly used for transportation (e.g., fiber to pulp and paper mills, and containerboard to converting facilities) and for forest-/sawmill-related operations.

NOTE: In this table, the main individual contributors are displayed in yellow.

Table 35 shows that, while coal was not an important contributor to fossil fuel depletion, it is an important contributor to non-renewable primary energy demand. Coal burned at pulp and paper mills and from purchased energy is the main contributor to the life cycle coal consumption.

Table 34. Contribution of the Various Life Cycle Stages/Groups of Unit Processes to the Fossil Fuel Depletion Results by Fuels, TRACI Method (Industry-Average)

Life cycle stage/Unit process	Crude oil	Natural gas	Others	Total
Total	24.8%	71.3%	3.9%	100.0%
1. Pulp and papermaking operations	13.3%	52.2%	3.3%	68.8%
Fiber	8.3%	1.5%	0.0%	9.9%
Energy	4.2%	48.6%	3.2%	55.9%
Rest	0.8%	2.1%	0.0%	2.9%
2. Converting	8.0%	18.8%	0.6%	27.4%
Natural gas used at converting	0.1%	10.3%	0.0%	10.4%
Transportation of containerboard	3.1%	0.2%	0.0%	3.3%
Others (mainly purchased power)	4.8%	8.3%	0.6%	13.7%
3. Use	2.9%	0.2%	0.0%	3.1%
4. End-of-Life	0.6%	0.1%	0.0%	0.7%

NOTE: In this table, the main individual contributors are displayed in yellow.

Table 35. Contribution of the Various Life Cycle Stages/Groups of Unit Processes to the Non-Renewable Primary Energy Results by Fuels, GaBi Method (Industry-Average)

Life cycle stage/Unit process	Crude oil	Coal	Natural Gas	Others	Total
Total	17.1%	32.4%	49.5%	1.0%	100.0%
1. Pulp and papermaking operations	9.2%	27.0%	36.2%	0.5%	72.9%
Fiber	5.8%	0.4%	1.0%	0.1%	7.3%
Energy	2.9%	26.9%	33.7%	0.3%	63.7%
Rest	0.5%	-0.2%	1.6%	0.0%	1.9%
2. Converting	5.6%	5.4%	13.0%	0.4%	24.4%
Natural gas used at converting	0.1%	0.1%	7.1%	0.0%	7.3%
Transportation of containerboard	2.1%	0.0%	0.1%	0.0%	2.3%
Others (mainly purchased power)	3.3%	5.3%	5.8%	0.4%	14.8%
3. Use	2.0%	0.0%	0.0%	0.1%	2.2%
4. End-of-Life	0.3%	0.0%	0.3%	0.0%	0.6%

NOTE: In this table, the main individual contributors are displayed in yellow.

6.2.8 Renewable Energy Consumption

The GaBi method was used to compute the primary renewable energy demand (RPE). Renewable energy demand is mainly from the pulp and paper making operations life-cycle stage (93%) and consists of hogged fuel (self-generated and purchased) and black liquor solids.

6.2.9 Water Use and Water Consumption

As shown in Figure 17, the pulp and papermaking operations life cycle stage is the main contributor to water use but not to water consumption. Within the pulp and papermaking operations life-cycle stage, it is the pulp and paper mills that use the most water but these return

a significant portion to the environment. Within converting, some chemicals contribute significantly to water use and consumption: starch, wax and ink.

6.3 Sensitivity Analyses

This section presents results of sensitivity analyses that have been performed on parameters others than the LCIA method and methods for biogenic CO₂: a) parameters that contribute significantly to the results and have significant uncertainty associated with them and b) methodological choices with potential effect on the results. Sensitivity analyses were performed on the following aspects:

- allocation method for sold power (S1);
- transportation distance for containerboard to converting facilities (S2);
- board mix (S3);
- recovery rate (S4).

Figure 21 presents a summary of the sensitivity analysis results. The actual analyses performed and the detailed results are presented in the Section 6.3.1 to 6.3.4, below.

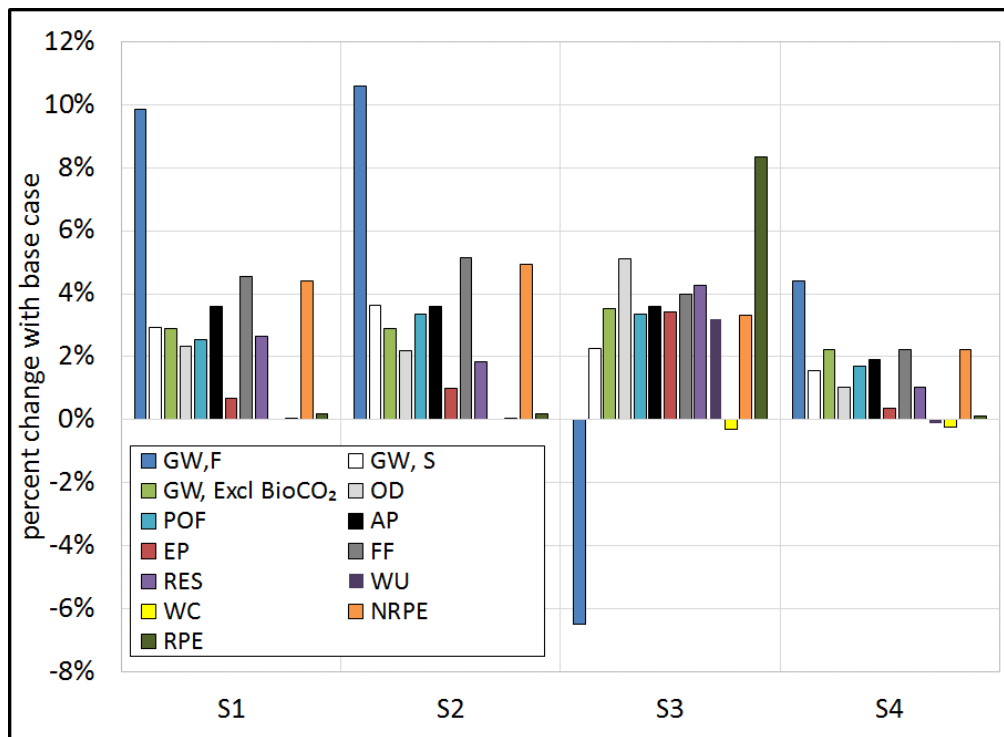

Figure 21. 2014 LCA Sensitivity Analysis Results

6.3.1 Allocation Method for Sold Power (S1)

In the base case analysis, fuels and combustion-related emissions were allocated to either energy used in the mill and/or sold energy, based on energy content and the hierarchy illustrated in Table 3. In this sensitivity analysis, system expansion was used instead. This method is one that is used extensively for electricity by LCA practitioners. To apply this method, it was assumed

that the burdens associated with purchased power were displaced. Using system expansion instead of allocation had little effect on the results as illustrated in Figure 21 (less than 2% difference with the base case)

6.3.2 Transportation Distance for Containerboard to Converting Facilities (S2)

In the base case analysis, most transportation distances were based on U.S. Census data, which are averaged across different categories and not necessarily specific to the product studied. Transportation of the containerboard to converting facilities was shown to be significant for some impact categories. Hence, this parameter was tested using sensitivity analysis by increasing the truck transportation distance by 50%. This had little effect on the results (less than 3% difference with the base case).

6.3.3 Board Mix (S3)

The board mix can potentially have significant effect on the results. In this study, the board mix for containerboard that is produced and used in the U.S. was estimated using data on exports. This sensitivity analysis looked at the effect at modeling board mix for containerboard produced in the U.S., irrespective of the exports, as shown in Table 36. The main effect of changing the board mix to include all board produced in the U.S. (including exports) is to reduce the global warming indicator results (GW, F) by 15%, mainly because of more removals of carbon from the atmosphere are included within the system boundary (from the production of all other linerboard). Another effect of the change in board mix is to increase the usage of renewable energy, again due to the increase in all other linerboard production.

Table 36. Sensitivity Analysis on Board Mix

Board type	2014 Produced in the U.S. (S3)	Produced and Used in the U.S.* (Base Case)
100%-recycled linerboard	14%	16.1%
All other linerboard	56%	50.7%
Total linerboard	70%	66.8%
100%-recycled corrugating medium	13%	14.4%
All other corrugating medium	17%	18.8%
Total corrugating medium	30%	33.2%

*Estimated based on U.S. actual production excluding imports.

6.3.4 Recovery Rate (S4)

The recovery rate for OCC has been increasing steadily and reached 92.9% in 2015 (compared to 89.5% in 2014). Hence, this sensitivity analysis tested the effect of increasing the recovery rate to 92.9%. The main effects observed were on the global warming indicator (GW, F) results, which were reduced by 15.6% due to lower GHG emissions, mainly methane, from landfills.

7. RESULTS AND INTERPRETATION: YEAR-TO-YEAR COMPARISON

7.1 Comparison Results

Figure 22 compares the impact/inventory indicators results obtained for 2014 with those obtained for 2006 and 2010. In general, changes by less than 10% are not considered meaningful (Franklin Associates 2004).

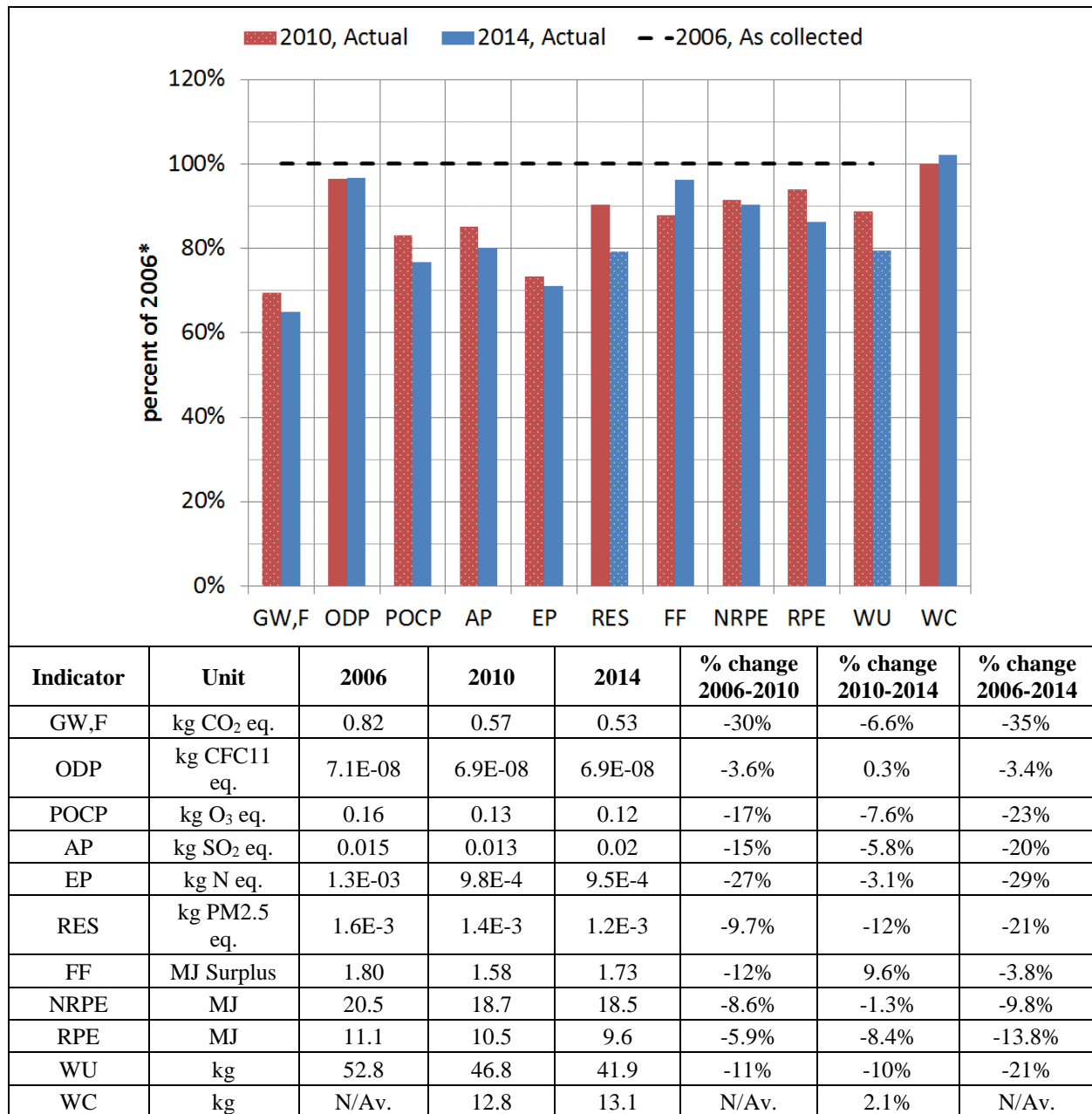

Figure 22. Comparison of 2014, 2010 and 2006 Impact Scores

*With exception of water consumption (WC) that is express as percent of 2010. Indicators that show a percent change greater than 10% compared to the previous year are shown with dots. In general, changes by less than 10% are not considered meaningful. However, explanations for change greater than 5% are still given below.

| 7. Result and Interpretation: Year-to-Year Comparison

It can be seen from the figure above that most environmental improvement occurred between 2006 and 2010. Between 2010 and 2014, the environmental performance was rather stable with modest improvement, mainly in particulates (RES) and water use (WU); and modest increase in fossil fuels depletion. Each indicator is further discussed below focusing on the differences observed between 2010 and 2014.

7.1.1 Global Warming

Between 2010 and 2014, the global warming indicator results were slightly reduced (-6.6%, a change that is not considered meaningful). Figure 23 provides more insight regarding the variations in the various components of the global warming results.

1. In 2014, the recovery rate was higher than in 2010, causing less corrugated product to end up in landfills thereby reducing methane emissions.
2. Direct emissions and emissions from purchased electricity and steam of fossil fuel-related CO₂, methane and nitrous oxide from containerboard mills were reduced by 13% in 2014 compared to 2010. This was mainly due to an increase of the share of the 100%-recycled product in the containerboard mix and to a reduction of energy consumption and/or switch to less carbon intensive fuels at containerboard mills.
3. The GHG emissions from converting increased due to higher reported fossil fuel combustion, in particular natural gas.
4. Increase in 100%-recycled products in the board mix results in lower removals. Removals contribute to offset emissions of GHGs.

7. Result and Interpretation: Year-to-Year Comparison

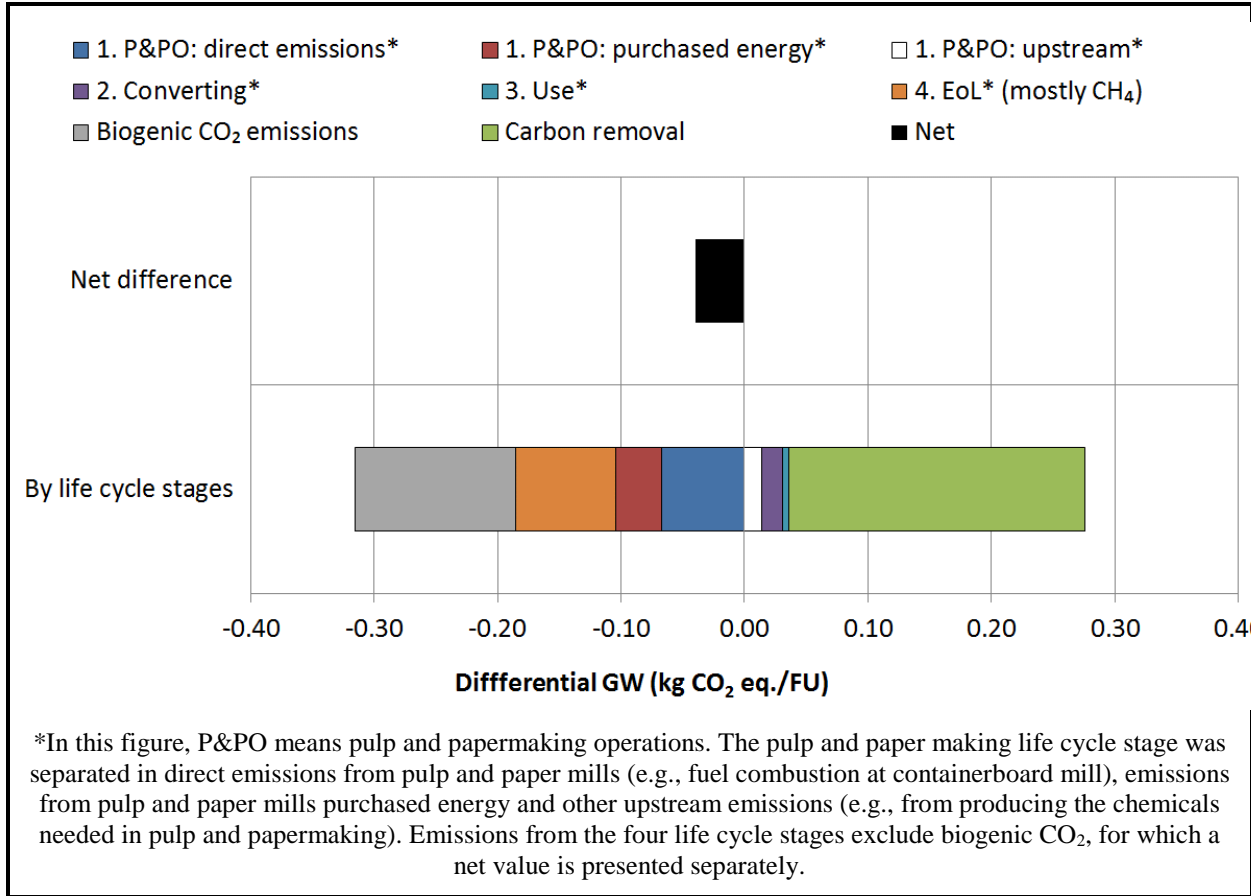

Figure 23. Explanation of the Difference in GHG Emissions between 2010 and 2014

Figure 24 below illustrates the various types of emissions/removals relevant to the flow accounting method. It can be seen that both emissions of biogenic CO₂ and of non-biogenic CO₂ GHG are decreasing over time. However, there is also a trend of reduced carbon removals due to increase recycled content in the products.

7. Result and Interpretation: Year-to-Year Comparison

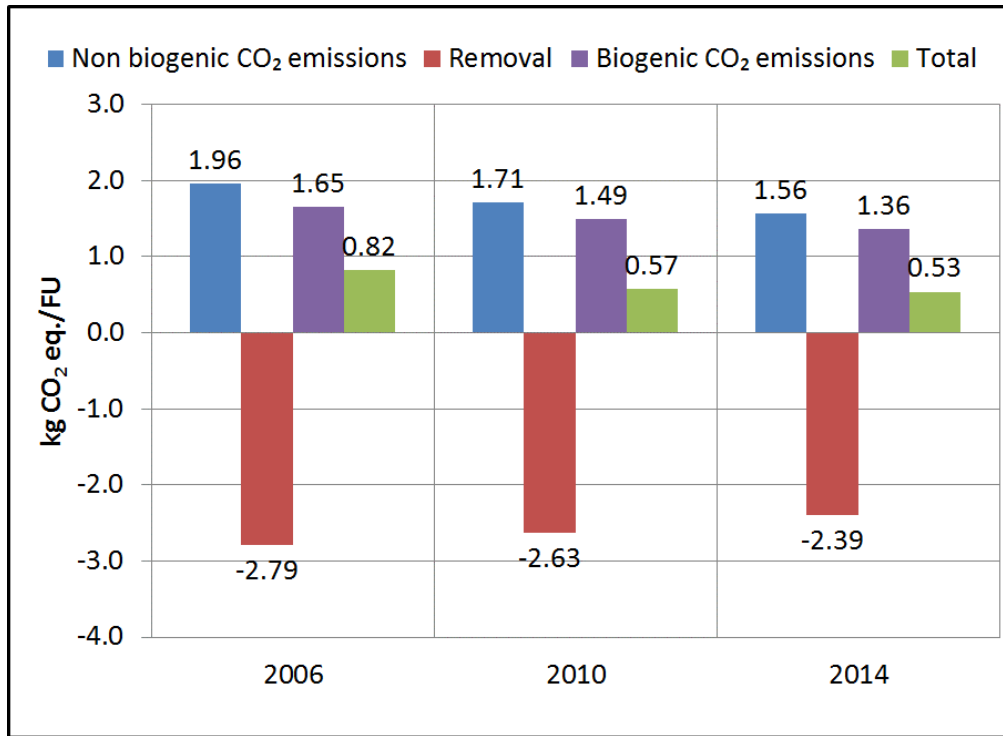

Figure 24. Yearly Comparison of Global Warming Results, Details of the Flow Accounting Method

The indicator for quantifying climate change impacts and the approach for accounting for biogenic CO₂ have the potential to have a significant effect on the comparison of results in different years. For this reason, the flow accounting method used in this study is compared to a stock change accounting method and to quantifying non-biogenic CO₂ GHGs only. The results, presented in Figure 25, show that applying stock change accounting also shows a modest decrease in global warming between 2010 and 2014. This is also observed when looking at non-biogenic CO₂ GHGs only. This is mainly due to an increase of the share of the 100%-recycled product in the containerboard mix, and to a reduction of energy consumption and/or switch to less carbon intensive fuels at containerboard mills.

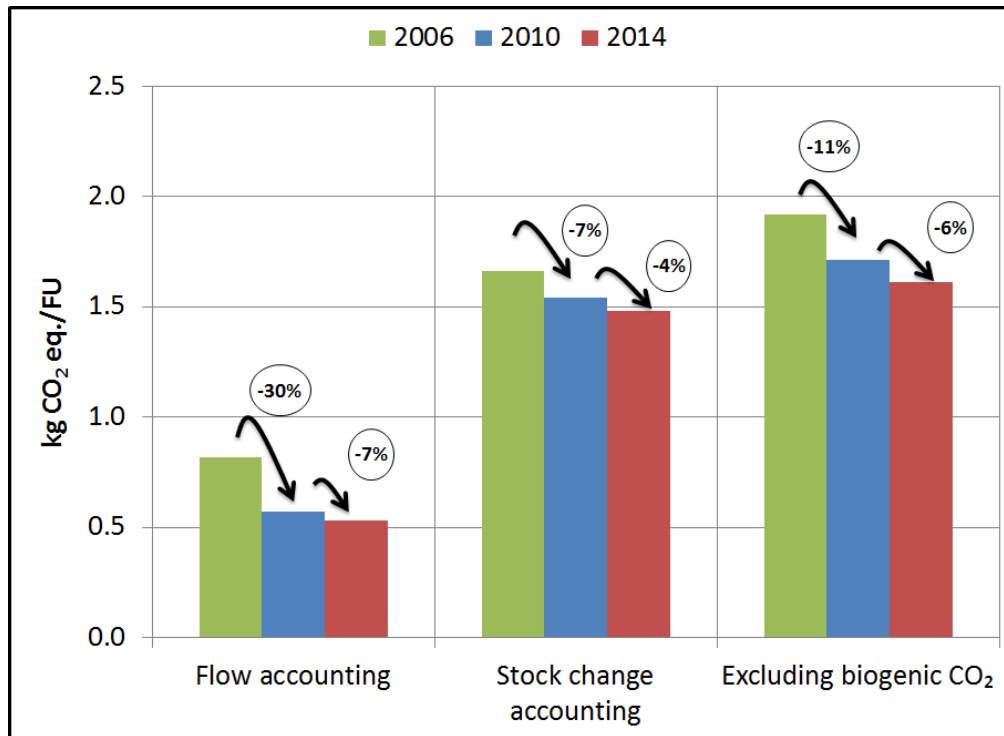

Figure 25. Effect of Biomass CO₂ Accounting on Yearly Comparison

7.1.2 Ozone Depletion

The release of ozone depleting substances remained stable between 2010 and 2014.

7.1.3 Smog

Smog was reduced by 8% between 2010 and 2014. This is mainly due to a reduction in NO_x released at containerboard mills and from purchased energy.

7.1.4 Acidification

Acidification was reduced by 6% between 2010 and 2014. This is mainly due to a reduction in NO_x and SO_x emissions at containerboard mills and from purchased energy.

7.1.5 Eutrophication

Eutrophication was reduced by 3% between 2010 and 2014, not a meaningful difference.

7.1.6 Fossil Fuel Depletion, Non-Renewable Primary Energy Demand and Renewable Energy Demand

Between 2010 and 2014, the impact score for fossil fuel depletion was increased by 9.6%. There two main drivers for this:

7. Result and Interpretation: Year-to-Year Comparison

- Increased consumption of fossil fuels, more specifically natural gas, by converting activities; and
- Increased natural gas share in the energy mix for containerboard mills.

Total non-renewable energy decreased by 1%, a change that is not meaningful. Total renewable energy decreased by 8%, mostly due to increase in the share of 100%-recycled products in the board mix. Total energy demand decreased slightly.

7.1.7 Respiratory Effects

The result of the respiratory effects indicator was reduced by 12% between 2010 and 2014 mainly due to reduction of emissions of SO₂ and particulates from containerboard mills, primarily due to a more natural gas in the fuel mix.

7.1.8 Water Use and Consumption

On one hand, there was a 10% reduction in water use between 2010 and 2014. The reduction in water use occurs mainly in the pulp and papermaking operations life cycle stage. There are two principal factors behind the water use reduction: containerboard mills and, more importantly, a greater share of 100%-recycled products in the board mix. On the other hand, water consumption was relatively stable. Decrease in water use at pulp and paper mills often comes at the expense of increased water consumption explaining why decrease water used is not resulting in decreased water consumption.

7.2 Sensitivity Analyses

In Section 6.3, a sensitivity analysis was performed to evaluate the effect of methodological choices and uncertainty on the calculated environmental performance of the 2014 corrugated product. In this section, the sensitivity of the 2010/2014 comparison by changing parameters with potential effect on the comparison which are potentially more uncertain than others. More specifically, the effect of the board mix is tested.

7.2.1 Board Mix

The board mix can potentially have a significant effect on the results. In this study, the board mix for containerboard that is produced and used in the U.S. was estimated using data on exports. This sensitivity analysis looked at the effect at modeling the board mix for 2014 containerboard produced in the U.S. while considering exports, as shown in Table 36. This board mix that includes exports is also very similar to the board mix observed for 2010. In this board mix, the share of boards from all other linerboard is increased. All other linerboard is the board type with the most carbon removals.

The results of these sensitivity analyses are presented in Figure 26. The figure shows that increasing the share of all other linerboard in the board mix:

- Significantly increases the difference between 2010 and 2014 (2014 presents an even lower global warming indicator compared to 2010);
- Changes the water use result from a meaningful to a non-meaningful reduction; and

7. Result and Interpretation: Year-to-Year Comparison

- Has no significant effect for the interpretation of the comparison results in terms of the remaining indicators.

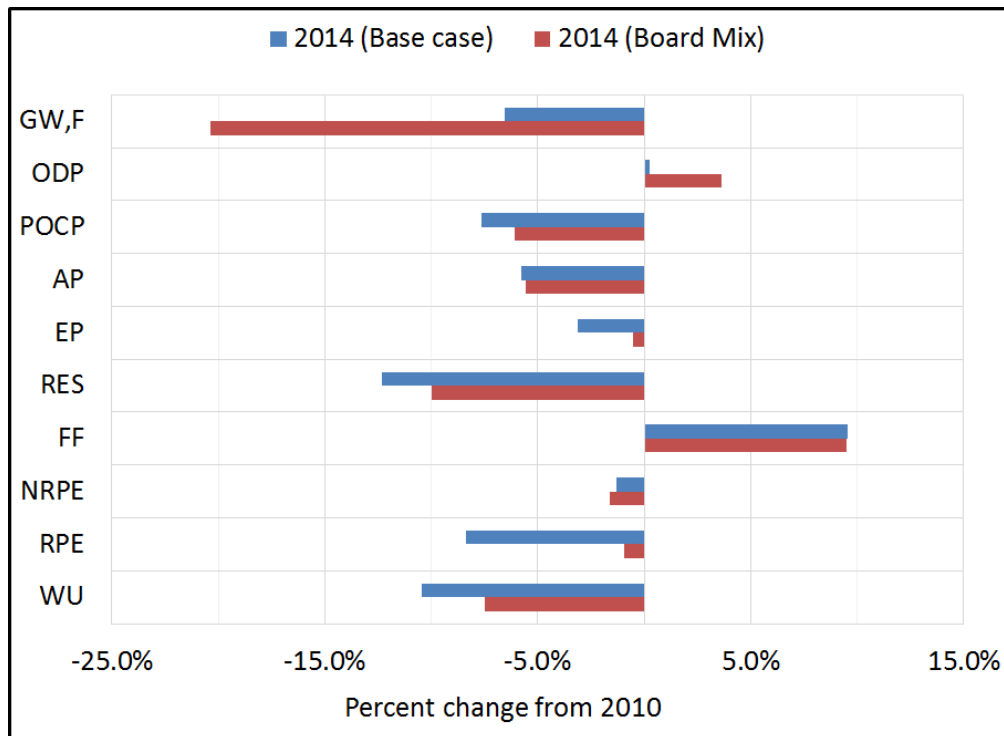

Figure 26. Effect of Board Mix on Comparison with 2010

7.2.2 Basis Weight

In this study, the annual environmental performance of 1 kg of corrugated product is analyzed and compared. However, two corrugated products of the same weight are not necessarily functionally equivalent since the functionality of a corrugated product is more related to its volume than to its weight. As such, if the basis weight goes down, less corrugated product, on a mass basis, is required to achieve the same volume functionality.

Data in Table 37 show that basis weight decreased with time. In this sensitivity analysis, we test the effect of the basis weight reduction on the results. For instance, due to the decrease in basis weight, it is possible to argue that only 0.952 kg of corrugated product is needed in 2010 to perform the same function as 1 kg of corrugated product in 2006.

The results of this sensitivity analysis are presented in Figure 27, which shows that making the comparison on a volume-equivalent functional unit would have shown greater reduction, or lower increase, in environmental indicator results.

Table 37. Basis Weight Sensitivity Analysis Settings

Year	Basis Weight	Functional Unit Adjustment
2006	138.6 lb/thousand square feet (msf, 0.677 kg/m ²)	1 kg
2010	131.9 lb/thousand square feet (msf, 0.644 kg/m ²)	0.952 kg
2014	131.6 lb/thousand square feet (msf, 0.643 kg/m ²)	0.949 kg

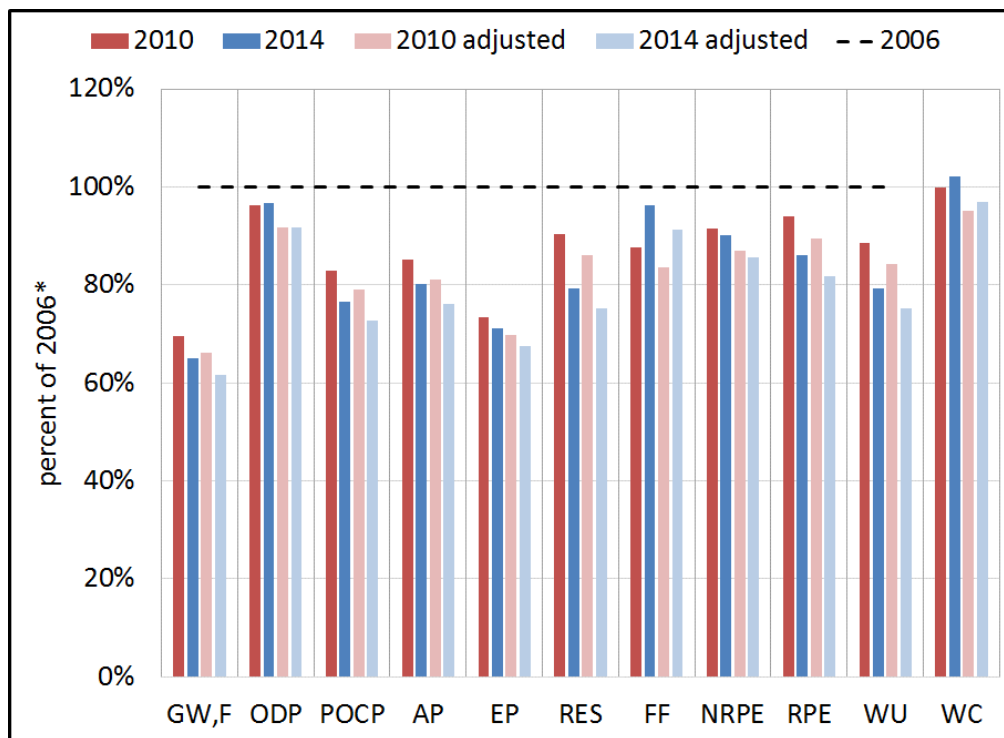

Figure 27. Effect of Functional Unit Definition on Observed Environmental Performance

*With exception of water consumption (WC) that is express as percent of 2010.

8. RESULTS AND INTERPRETATION: 100%-RECYCLED VS. INDUSTRY-AVERAGE

In this section, the environmental performance of the 100%-recycled product relative to that of the industry-average product is evaluated using two different allocation methods for recycling: the Number of Uses (NOU) Method and the Closed-Loop Approximation with Cut-Off Method. Section 8.1 presents the results using the NOU Method, while section 8.2 presents the results using the Closed-Loop Approximation with Cut-Off Method.

These two methods provide a different perspective on how the environmental load of virgin production processes should be distributed between all usages of the fiber (i.e., virgin and recycled). The main difference between the two methods is that the Cut-Off Method assigns the environmental loads and benefits from virgin material production to the products made of virgin fiber only while the Number of Uses method shares the loads and benefits between the products made of virgin fiber and those made of recycled fiber. In addition to the Closed-Loop Approximation with Cut-Off Method used for the industry-average LCA, The Number of Uses method was selected for several reasons. Among them is a recommendation from an international working group addressing LCI issues, as included in a 1996 report by AF&PA (*Life Cycle Inventory Analysis User's Guide - Enhanced Methods and Applications for the Products Industry*), that this method be used in LCA studies of paper because it is the only one that reflects the complex interactions between new and recycled fiber. The results obtained applying both methods are presented for consideration.

8.1 Number-of-Uses Method

8.1.1 Indicator Results and Significant Issues

This section presents the results for the impact categories and inventory indicators for the 100%-recycled product as well as simplified contribution analyses. The results presented are for the Number of Uses (NOU) method. Note that LCIA results are relative expressions and do not predict impacts on category endpoints, the exceeding of thresholds, safety margins or risks.

LCIA indicator results are presented in Table 38 and inventory indicators in Table 39.

Table 38. LCIA Indicator Results per Functional Unit (100%-Recycled, NOU Method)

Impact categories proposed by ISO 14047	Nomenclature	TRACI method	CML method	IPCC AR5 GWPs
Global warming, flow accounting	GW,F			1.67 kg CO ₂ eq.
Global warming, stock change accounting	GW,S			1.62 kg CO ₂ eq.
Global warming, excluding biogenic CO ₂	GW,ExclBioCO ₂			1.77 kg CO ₂ eq.
Stratospheric ozone depletion	ODP	4.02E-08 kg CFC-11 eq.		
Photo-oxidant formation	POCP	0.108 kg O ₃ eq.	0.0126 kg C ₂ H ₄ eq.	
Acidification	AP	0.0120 kg SO ₂ eq.*	0.0132 kg SO ₂ eq.	
Nitrification/Eutrophication	EP	5.84E-4 kg N eq.*	8.48E-4 kg PO ₄ eq.	
Depletion of abiotic resources (e.g., fossil fuels, minerals)	FF	1.74 MJ surplus		
Respiratory effects inorganics substances**	RES	9.89E-4 kg PM2.5 eq.		

*Total of air and water.

Table 39. LCI Indicator Results per Functional Unit (100%-Recycled, NOU Method)

Additional indicator	Nomenclature	Results
Non-renewable primary energy demand	NRPE	20.7 MJ
Renewable primary energy demand	RPE	2.77 MJ
Water use	WU	31.1 kg
Water consumption	WC	14.8 kg

Contribution analyses are presented in Figure 28, Figure 29 and Figure 30. Using the NOU approach, the 100%-recycled product has a similar environmental profile to that of the industry-average presented previously (Section 6). Notable exceptions include:

- The pulp and papermaking life cycle stage contributes more towards the global warming indicator calculated using flow accounting (GW,F). The reason is that there is very little carbon removal to offset emissions of GHGs.
- The contribution of the pulp and papermaking life cycle stage to renewable energy consumption is less significant. However, in the case of the NOU method, there is an imported virgin production load (NOU credit) that comes with the recovered fiber used in containerboard production. This additional environmental load contributes significantly towards renewable energy consumption.

8. Result and Interpretation: 100%-Recycled vs. Industry-Average

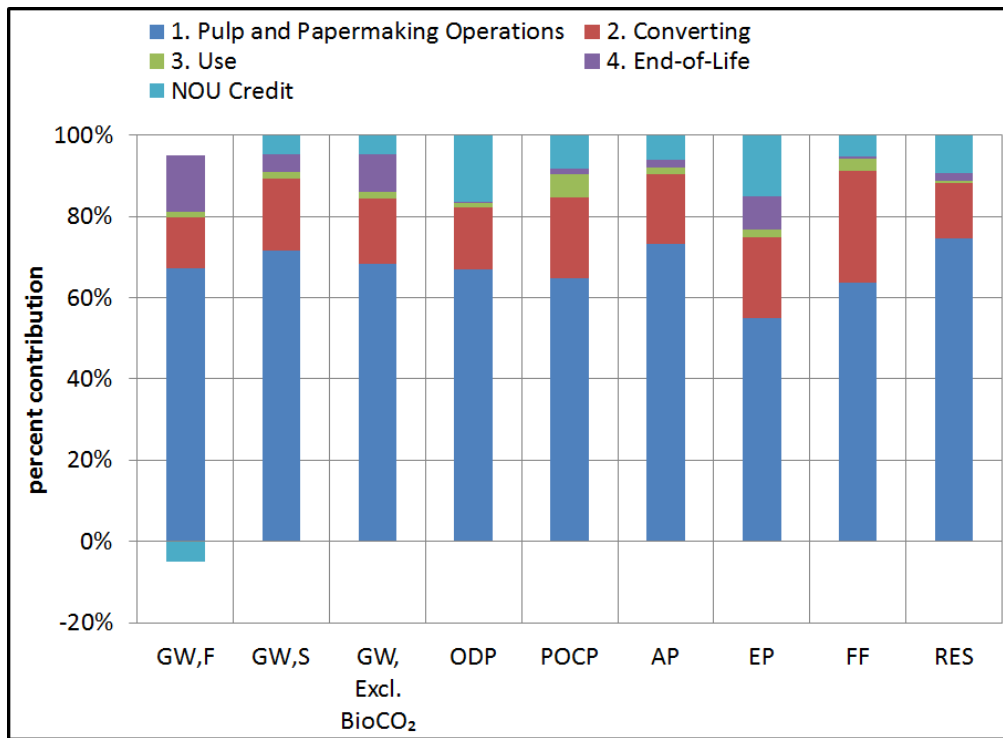

Figure 28. Contribution Analyses for LCIA Indicators, TRACI and IPCC (100%-Recycled, NOU Method)

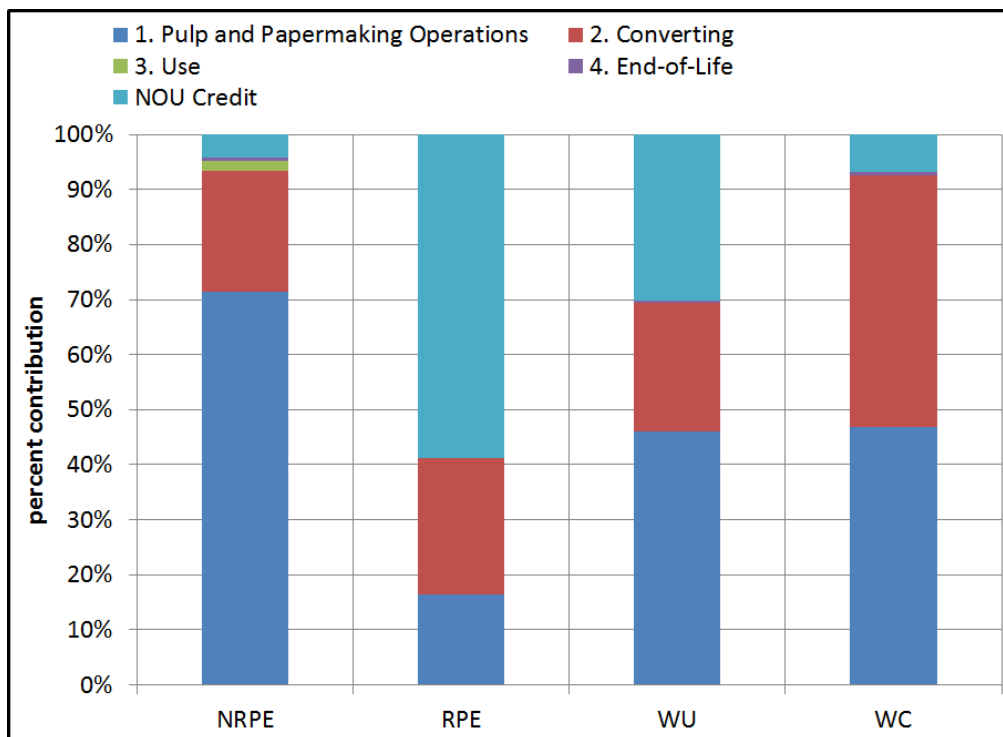

Figure 29. Contribution Analyses for LCI Indicators (100%-Recycled, NOU Method)

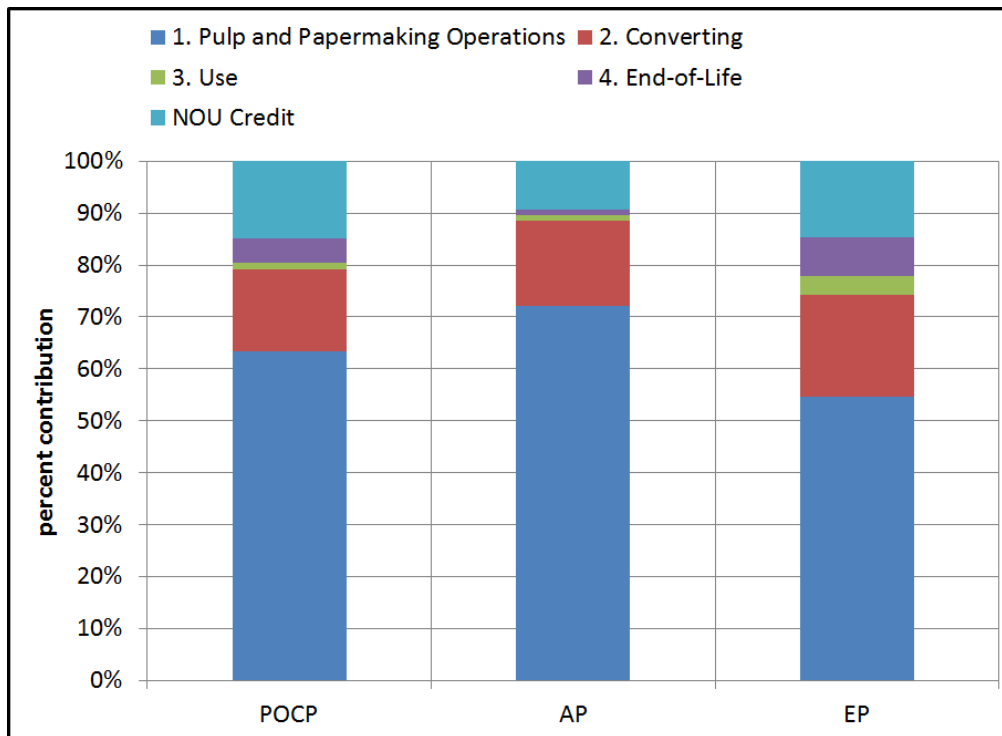

Figure 30. Contribution Analyses for LCIA Indicators, CML Method (100%-Recycled, NOU Method)

8.1.2 Comparison with Industry-Average

Figure 31 compares the LCIA and inventory indicator results for the 100%-recycled and industry-average corrugated product using the NOU method. It can be seen from the figure that when applying the NOU method, the 100%-recycled product shows:

- Lower environmental score result than the industry-average product for the following environmental indicators: renewable energy demand (RPE) and water use (WU);
- No meaningful difference with the industry-average product for the following environmental indicators: ozone depletion (ODP) and eutrophication (EP); and
- Higher environmental score results for all remaining indicators.

More details on each indicator are provided next.

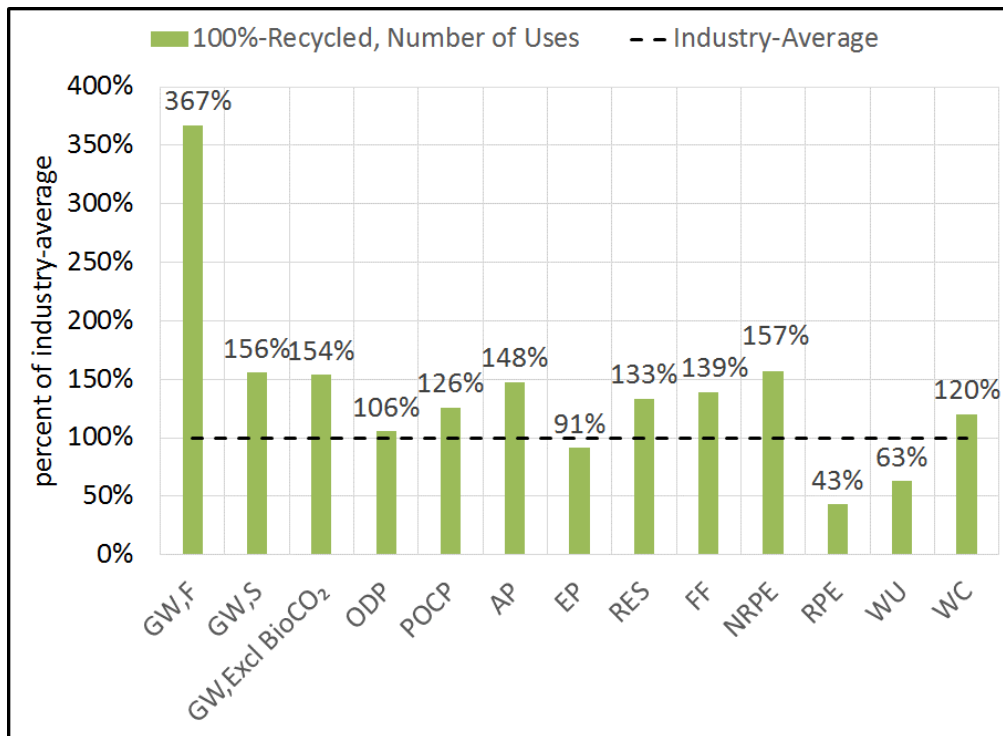

Figure 31. Impact Scores for the 100%-Recycled Product Relative to that of the Industry-Average Product (NOU Method)

8.1.2.1 Global Warming

Using the NOU method, the global warming results are significantly higher for the 100%-recycled product than for the industry-average product, and this irrespective of the global warming indicator used. Figure 32 explores the drivers for this results in the case of the global warming indicator calculated using the flow accounting approach (GW,F).

Two main reasons explain this difference:

- 1) Although the application of the NOU method involves the import of net carbon sequestration (NOU benefit on the figure) benefits from other product systems, there are still significantly more removals of CO₂ from the atmosphere associated with the industry-average that are not offset by emissions at the end-of-life because 89.5% the product is recovered for recycling; and
- 2) The 100%-recycled product consumes more purchased energy that is almost fully generated using fossil fuels.

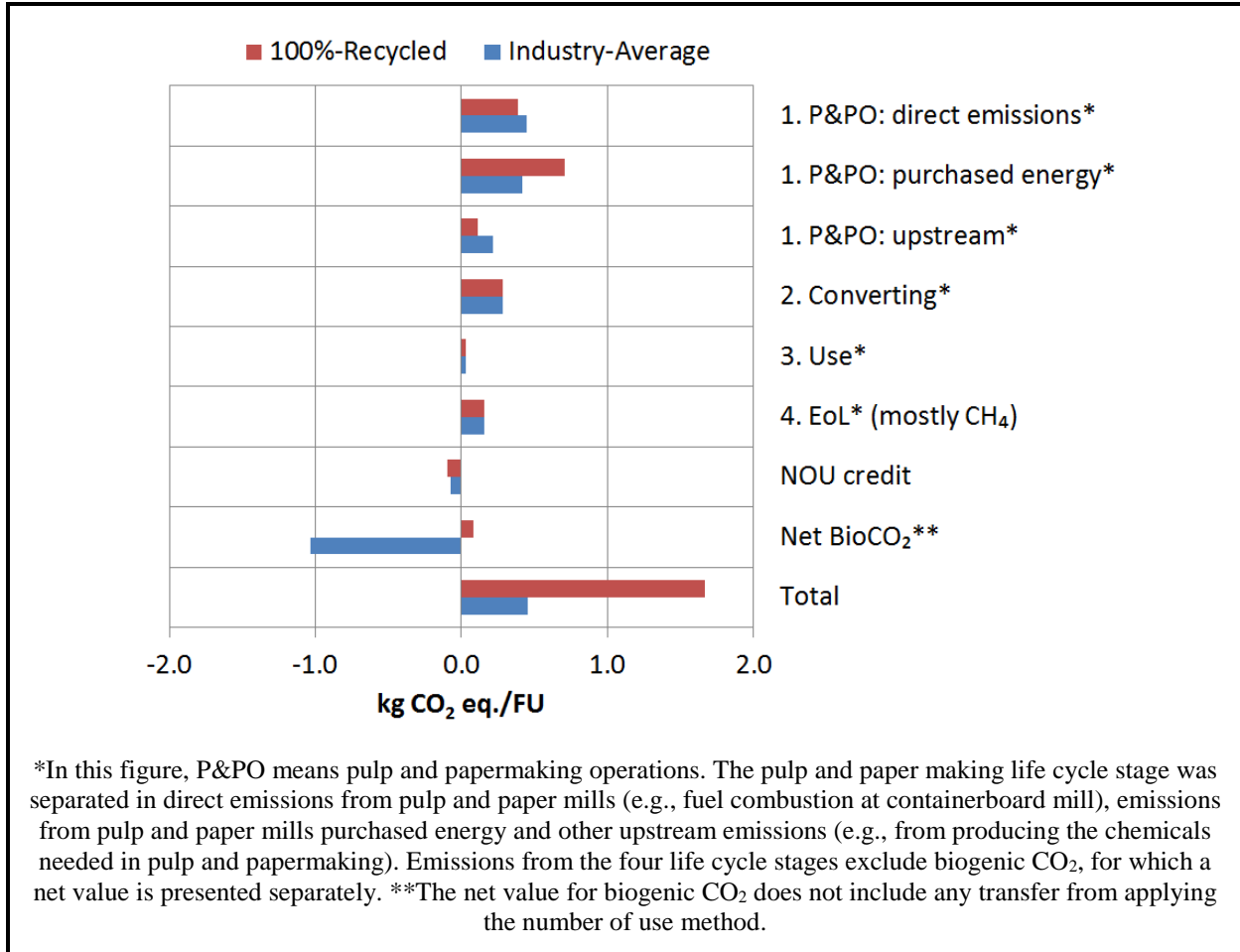

Figure 32. Difference in GHG Emissions between the Industry-Average and 100%-Recycled Products (NOU Method)

When analyzing the differences in global warming results between the industry-average and 100%-recycled product, it is important to understand the difference between "recovery rate" and "utilization rate." On one hand, the recovery rate is the fraction of old corrugated containers recovered at the end-of-life to be recycled. The recovery rate applies equally to all corrugated products (industry-average or 100%-recycled) because all corrugated products are recovered at the same rate, regardless of their content of recovered fiber. On the other hand, the utilization rate describes the quantity of recovered fiber used in containerboard production. The utilization rate is thus different for 100%-recycled corrugated products compared to that for industry-average products. Methane from landfills is avoided when material is diverted from the waste stream (increasing the recovery rate). Once it is recovered, fiber may go to a number of different uses, including utilization as raw material for containerboard (affecting the utilization rate). The utilization rate affects emissions primarily via its effects on manufacturing operations and upstream emissions related to production of raw materials and energy.

This report previously examined the differences in industry-average corrugated product between 2010 and 2014 and found that for end-of-life, with respect to greenhouse gas emissions, they were lower in 2014 due to the increased recovery rate (less landfill methane). In the context of comparing 100%-recycled product with industry-average, methane reduction from landfills is not

a factor because the recovery rate, and hence the quantity of product going to landfill, is the same for both product types.

8.1.2.2 Ozone Depletion (ODP)

The releases of ozone-depleting substances are similar for the 100%-recycled and industry-average products. There are more releases of ozone-depleting substances from virgin production processes than for recycling processes. However, when applying the NOU method, a portion of the releases from virgin production processes are shared over the multiple uses of the fiber resulting in the first (virgin) use carrying less of the load. The amounts shared are assigned to subsequent (recycled) uses, causing the releases of ozone-depleting substances.

8.1.2.3 Smog (POCP)

The releases of substances contributing towards the smog indicator are higher for the 100%-recycled product than for the industry-average product. This can be explained as follows. There are more releases of substances contributing towards the smog indicator from virgin production processes than for recycling processes. However, when applying the NOU method, a portion of the releases from virgin production processes are shared over the multiple uses of the fiber resulting in the first (virgin) use carrying less of the load. The amounts shared are assigned to subsequent (recycled) uses, causing the releases of substances contributing towards the smog indicator to be higher for the 100%-recycled product than for the industry-average product.

8.1.2.4 Acidification (AP)

The releases of acidifying substances are higher for the 100%-recycled product than for the industry-average product. This can be explained as follows. There are more releases of acidifying substances from virgin production processes than for recycling processes. However, when applying the NOU method, a portion of the releases from virgin production processes is shared over the multiple uses of the fiber resulting in the first (virgin) use carrying less of the load. The amounts shared are assigned to subsequent (recycled) uses, causing the releases of acidifying substance to be higher for the 100%-recycled product than for the industry-average product.

8.1.2.5 Eutrophication (EP)

The releases of eutrophying substances are higher for the 100%-recycled product than for the industry-average product. This can be explained as follows. There are more releases of eutrophying substances from virgin production processes than for recycling processes. However, when applying the NOU method, a portion of the releases from virgin production processes are shared over the multiple uses of the fiber resulting in the first (virgin) use carrying less of the load. The amounts shared are assigned to subsequent (recycled) uses, causing the releases of eutrophying substances to be higher for the 100%-recycled product than for the industry-average product.

8.1.2.6 Fossil Fuel Depletion (FF), Non-Renewable Primary Energy Demand (NRPE), and Renewable Energy Demand (RPE)

Using the NOU method, the 100%-recycled life cycle results in greater fossil fuel depletion and non-renewable energy demand scores. This can be explained as follows. In this case, recycled and virgin production processes contribute similarly to these two indicators. However, when applying the NOU method, a portion of fossil fuel usage from virgin production processes is shared over the multiple uses of the fiber resulting in the first (virgin) use carrying less of the load. The amounts shared are assigned to subsequent (recycled) uses, causing the score for the fossil fuel depletion and non-renewable energy demand indicators to be higher for the 100%-recycled product.

Using the NOU method, the 100%-recycled product consumes less renewable energy than the industry-average. Virgin production processes consume more renewable energy than recycling processes. Although in applying the NOU method a portion of renewable energy from virgin production processes is shared over the multiple uses of the fiber resulting in the first (virgin) use carrying less of the load and the recycled products more, this is not sufficient to change the overall picture in terms of renewable energy consumption.

8.1.2.7 Respiratory Effects (RES)

The results for the respiratory effects indicator are not significantly different for the 100%-recycled and industry-average products. Although direct particulate releases are lower for the 100%-recycled product, while considering the virgin production load that is transferred to 100%-recycled products when applying the NOU method these releases become equivalent for the two products.

8.1.2.8 Water Use (WU) and Water Consumption (WC)

Water use is significantly lower for the 100%-recycled product than for the industry-average product. This is mainly because pulp and papermaking using recycled fiber requires less water than using virgin fiber. However, water consumption is not significantly different for the two products. Water consumption does go up as a percentage of the intake as water use goes down. Water consumption will also increase on a volumetric basis as water use goes down because temperature management issues become more important, making water consumption equivalent for the two products. However, using the NOU method, virgin production burden is transferred to the recycled products and observed water consumption is higher for 100%-recycled corrugated product.

8.1.3 Sensitivity Analysis

This section presents results of sensitivity analyses that have been performed on: (a) parameters that contribute significantly to the results and have significant uncertainty associated with them, and (b) methodological choices with potential effects on the results. Sensitivity analyses were performed on the following aspects:

- LCIA method;
- accounting approach for biogenic CO₂;

8. Result and Interpretation: 100%-Recycled vs. Industry-Average

- board mix;
- electricity mix for 100%-recycled linerboard and medium; and
- under-representativeness of the 100%-Recycled corrugating medium in the collected data.

Results of these sensitivity analyses are discussed in the following paragraphs.

8.1.3.1 LCIA Method

Figure 33 compares the results obtained using the TRACI and CML methods for the acidification (AP), eutrophication (EP) and smog (POCP) indicators. This figure shows that the choice of the method has little effect on the results of the comparison for the acidification and smog indicators. TRACI and CML apply very different weightings to various substances in the eutrophication impact category. These differences are significant enough to affect the results of a comparison between the 100%-recycled and industry-average products. As shown in Figure 33, when using the TRACI indicator, the release of eutrophication substances was 9% lower for the 100%-recycled product than that of the industry-average. When using the CML method they are 8% higher mainly because CML does not attribute a significant importance to phosphorus releases.

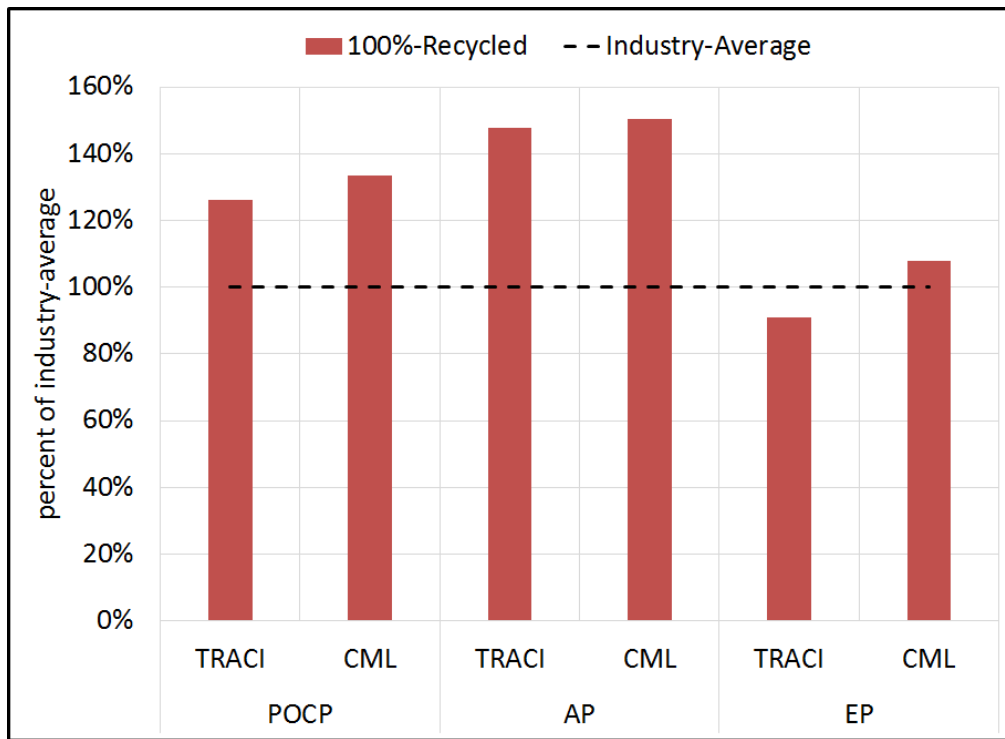

Figure 33. Results for the 100%-Recycled Product Relative to that of the Industry-Average Product: TRACI vs. CML (NOU)

8.1.3.2 Accounting Approach for Biogenic CO₂

The effect of the accounting approach used for biogenic CO₂ on the global warming indicator results was presented in Figure 28 and Table 43. When using flow accounting, the 100%-recycled product has a score for the global warming indicator that is 367% that of the industry-

average, whereas the score is approximately 155% of the industry-average score when using stock change accounting or when ignoring biogenic CO₂. This shows that although the magnitude of the difference between 100%-recycled and industry average varies significantly depending on the method used, the industry-average product always results in lower global warming impact.

8.1.3.3 Proportion of Each Individual Board Type in the Production Mix

When comparing the 100%-recycled product to the industry-average product, the ratio of linerboard to medium was kept constant, representing the realistic approach because the same product mix is compared. Another approach could have been to compare the actual industry-average corrugated product produced and used in the U.S. to the actual 100%-recycled corrugated product produced and used in the U.S (based on data from AF&PA). As shown in Table 40, applying this alternative approach affects the ratio of linerboard and medium in the corrugated product. While the industry-average product produced and used in the U.S. is made of 66.8% linerboard and 33.2% corrugated medium, the 100%-recycled product produced and used in the U.S. is made of 52.8% linerboard and 47.2% corrugated medium, indicating a difference in exports outside the U.S. of the different containerboard components.

Table 40. Mix of Boards in Corrugated Products

Board type	Industry-Average	100%-Recycled	
	Base Case Scenarios	Base Case Scenario	Actual U.S. Production and Usage
100%-recycled linerboard	16.1%	66.8%	52.8%
All other linerboard	50.7%	0%	0%
Total linerboard	66.8%	66.8%	52.8%
100%-recycled corrugating medium	14.4%	33.2%	47.2%
All other corrugating medium	18.8%	0%	0%
Total corrugating medium	33.2%	33.2%	47.2%

Figure 34 shows that the board mix does not affect significantly the results. This is because 100%-recycled linerboard and 100%-recycled medium have very similar environmental performance. From converting to end-of-life, they are assumed to have the same environmental profile. The production of 100%-recycled linerboard and 100%-recycled medium use similar quantities of fiber and of energy. Other aspects that differ between the two products, such as chemical and additive usage, are not very significant for the overall environmental performance of the two products. With few exceptions, recycled linerboard and recycled medium are produced at the same facilities. The most straightforward method for a mill to allocate environmental load to the two products would be to use mass allocation, which would result in the same environmental profile for the two products on a mass basis.

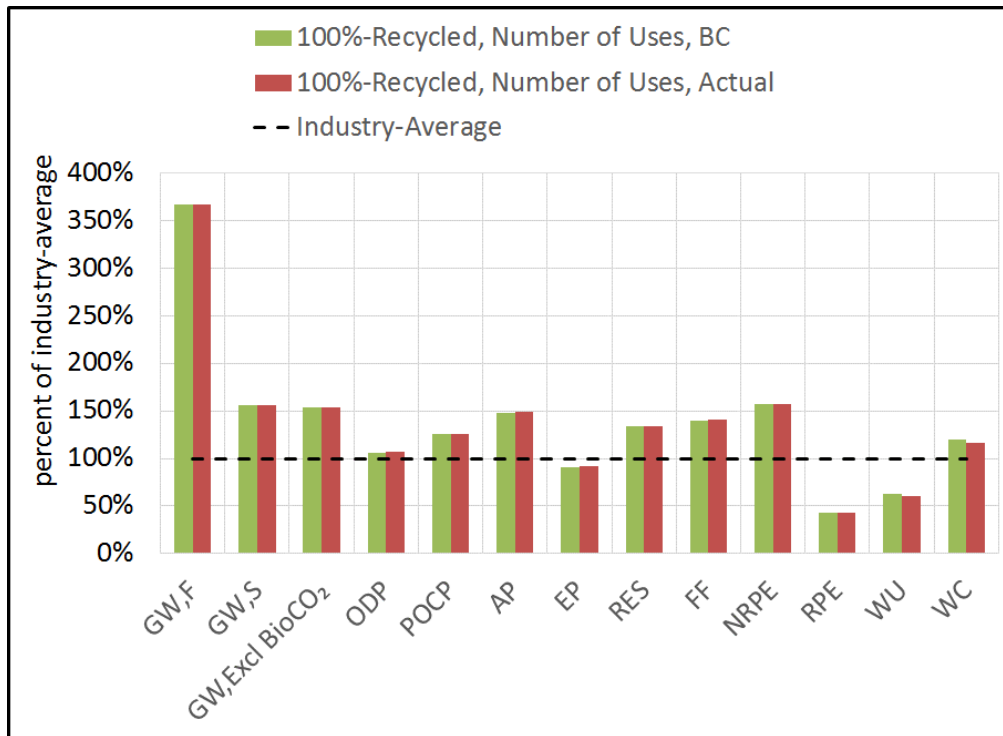

Figure 34. Effect of Board Mix on the Comparison of 100%-Recycled and Industry-Average Products (NOU Method)

8.1.3.4 Electricity Mix for 100%-Recycled Linerboard and Medium

The data collected for 100%-recycled linerboard and medium was exclusively from eastern U.S. states. However, there is 100%-recycled containerboard produced in other parts of the country. One effect of this is to skew the impact of the electricity mix modeled in the study. This sensitivity analysis assesses the effect of assuming the same electricity mix for 100%-recycled linerboard and medium as in 2010. As illustrated in Figure 35, this has little effect on the results.

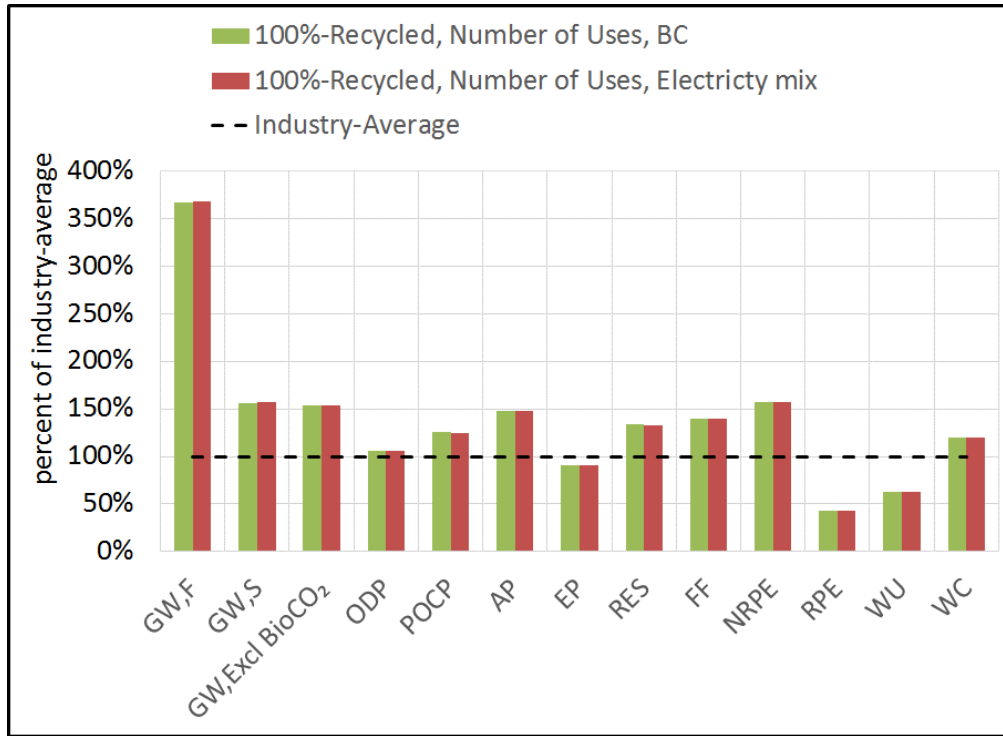

Figure 35. Effect of Electricity Mix on the Comparison of 100%-Recycled and Industry-Average Products (NOU Method)

8.1.3.5 Under-Representativeness of the 100%-Recycled Corrugating Medium in the Collected Data

One of the main limitations regarding the comparison of the industry-average and 100%-recycled products concerns the relatively low coverage of U.S. industry production of 100%-recycled medium represented by the mills providing data (only 40%). It was assumed that the data provided by these mills were representative of recycled medium production in the U.S. A sensitivity analysis was performed assuming the 100%-recycled corrugating medium not represented in the collected data performed (1) 50% worse than, and (2) 50% better than the represented 100%-recycled corrugating medium. A 50% difference was selected based on professional judgment, with the intent of examining a large difference from the average. The results are presented in Figure 36. As shown in this figure, under-representativeness of 100%-recycled medium is not expected to have a significant effect on the results.

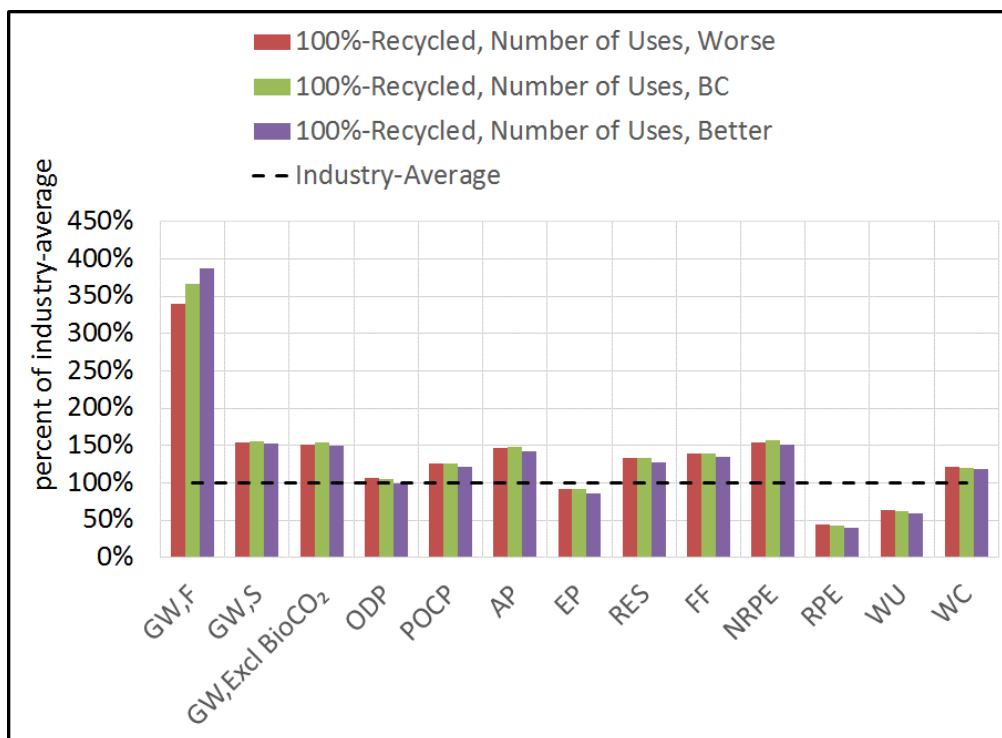

Figure 36. Sensitivity Analysis on the Potential Effect of Having 100%-Recycled Medium Under-Represented in the Collected Data (NOU Method)

8.2 Closed-Loop Approximation with Cut-Off Method

8.2.1 Indicator Results and Significant Issues

This section presents the results for the impact categories and inventory indicators for the 100%-recycled product as well as simplified contribution analyses. The results presented are for the Closed-Loop Approximation with Cut-Off Method (hereinafter referred to as the "Cut-Off Method"). Note that LCIA results are relative expressions and do not predict impacts on category endpoints, the exceeding of thresholds, safety margins or risks.

LCIA indicator results are presented in Table 41 and inventory indicators in Table 42.

8. Result and Interpretation: 100%-Recycled vs. Industry-Average

Table 41. LCIA Indicator Results per Functional Unit (100%-Recycled, Cut-Off Method)

Impact categories proposed by ISO 14047	Nomenclature	TRACI method	CML method	IPCC AR5 GWPs
Global warming, flow accounting	GW,F			1.77 kg CO ₂ eq.
Global warming, stock change accounting	GW,S			1.55 kg CO ₂ eq.
Global warming, excluding biogenic CO ₂	GW,ExclBioCO ₂			1.69 kg CO ₂ eq.
Stratospheric ozone depletion	ODP	3.36E-08 kg CFC-11 eq.		
Photo-oxidant formation	POCP	0.099 kg O ₃ eq.	1.17E-3 kg C ₂ H ₄ eq.	
Acidification	AP	0.0113 kg SO ₂ eq.*	0.0124 kg SO ₂ eq.	
Nitrification/ Eutrophication	EP	4.95E-4 kg N eq.*	7.56E-4 kg PO ₄ eq.	
Depletion of abiotic resources (e.g., fossil fuels, minerals)	FF	1.65 MJ surplus		
Respiratory effects inorganics substances**	RES	8.96E-4 kg PM2.5 eq.		

*Total of air and water.

Table 42. LCI Indicator Results per Functional Unit (100%-Recycled, Cut-Off Method)

Additional indicator	Nomenclature	Results
Non-renewable primary energy demand	NRPE	19.8 MJ
Renewable primary energy demand	RPE	1.14 MJ
Water use	WU	21.8kg
Water consumption	WC	13.8 kg

Contribution analyses are presented in Figure 37, Figure 38 and Figure 39. The 100%-recycled product has a similar environmental profile as that of the industry-average except for the pulp and papermaking operation life cycle stage. When compared to the industry-average, the pulp and papermaking life cycle stage is characterized mainly by:

- no virgin fiber feedstock and hence, no associated carbon removals;
- higher consumption of recovered fiber; and
- a very different energy profile (e.g., almost no renewable energy, more purchased steam, etc.).

8. Result and Interpretation: 100%-Recycled vs. Industry-Average

In consequence, the contribution analyses show quite different results for some indicators. For instance, while the pulp and papermaking operations (P&PO) life cycle stage was an insignificant contributor to the global warming indicator (GW,F) for the industry-average product, it is the main contributor for the 100%-recycled product. Also, the P&PO stage contributes less to the renewable energy, water use and water consumption indicators than does the industry-average product.

In the case of the 100%-recycled product, the P&PO stage is the main contributor to all indicators except for water consumption, for which converting is the main contributor. The converting life cycle stage is a significant contributor to all indicators. End-of-life is relevant only for the global warming indicator. The choice of the LCIA method did not greatly affect the results.

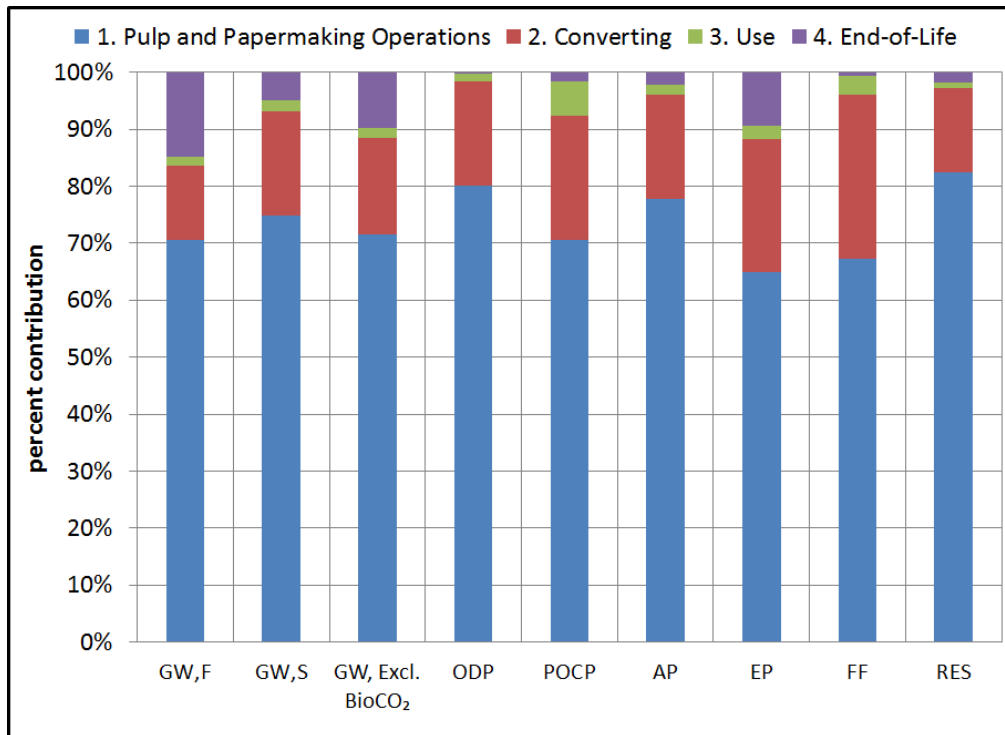

Figure 37. Contribution Analyses for LCIA Indicators, TRACI and IPCC (100%-Recycled, Cut-Off Method)

8. Result and Interpretation: 100%-Recycled vs. Industry-Average

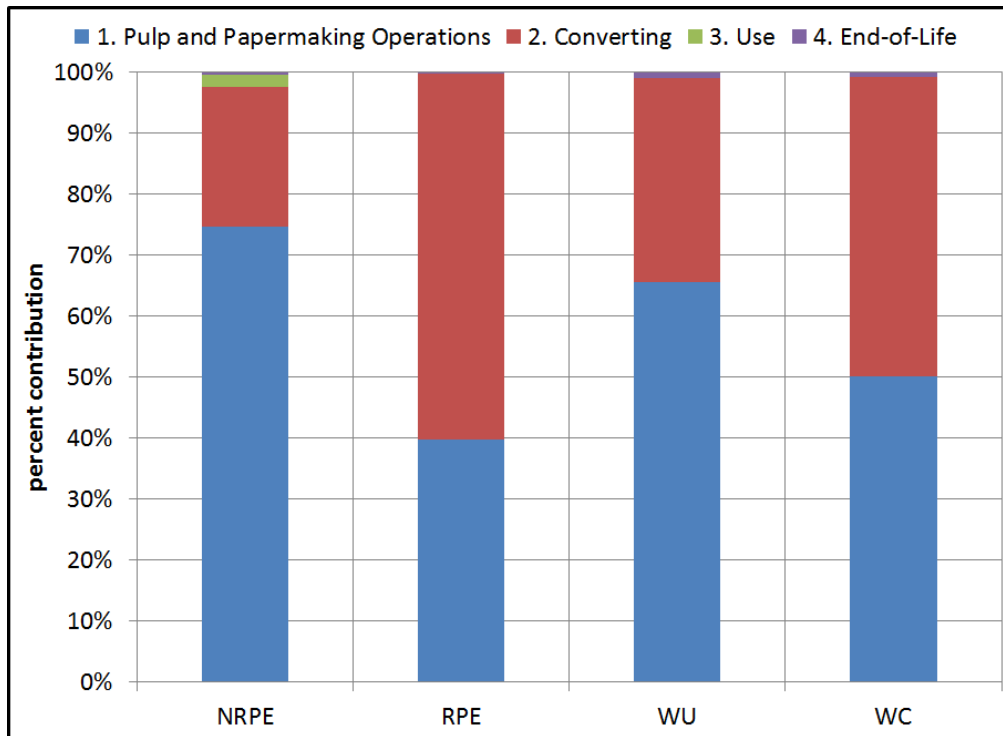

Figure 38. Contribution Analyses for LCI Indicators (100%-Recycled, Cut-Off Method)

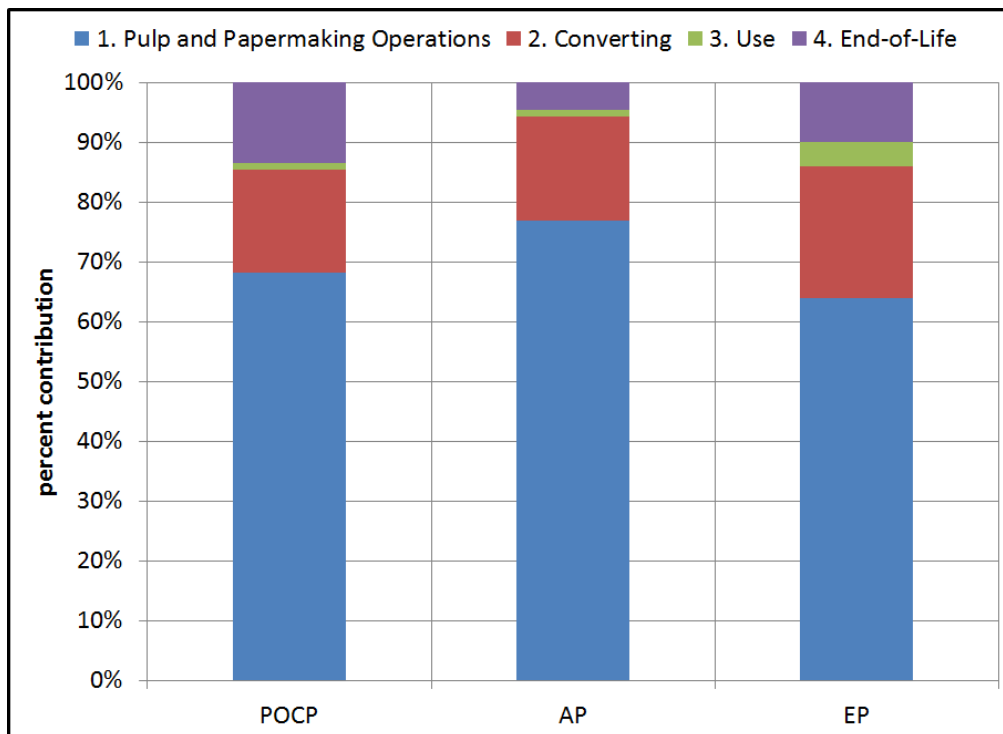

Figure 39. Contribution Analyses for LCIA Indicators, CML Method (100%-Recycled, Cut-Off Method)

8.2.2 Comparison with Industry-Average

Figure 40 compares the LCIA and inventory indicator results for the 100%-recycled and industry-average corrugated product using the Cut-Off method. It can be seen from the figure that, when applying the Cut-Off method, the 100%-recycled product shows:

- Lower environmental score result than the industry-average product for the following environmental indicators: ozone depletion (ODP), smog, (POCP), eutrophication (EP), respiratory inorganics (RES), renewable energy demand (RPE), and water use (WU);
- No significant difference with the industry-average product for the following environmental indicators: acidification (AP), fossil fuels depletion (FF), non-renewable energy demand (NRPE) and water consumption (WC); and
- Higher environmental score results for the global warming indicator.

More details on each indicator are provided next.

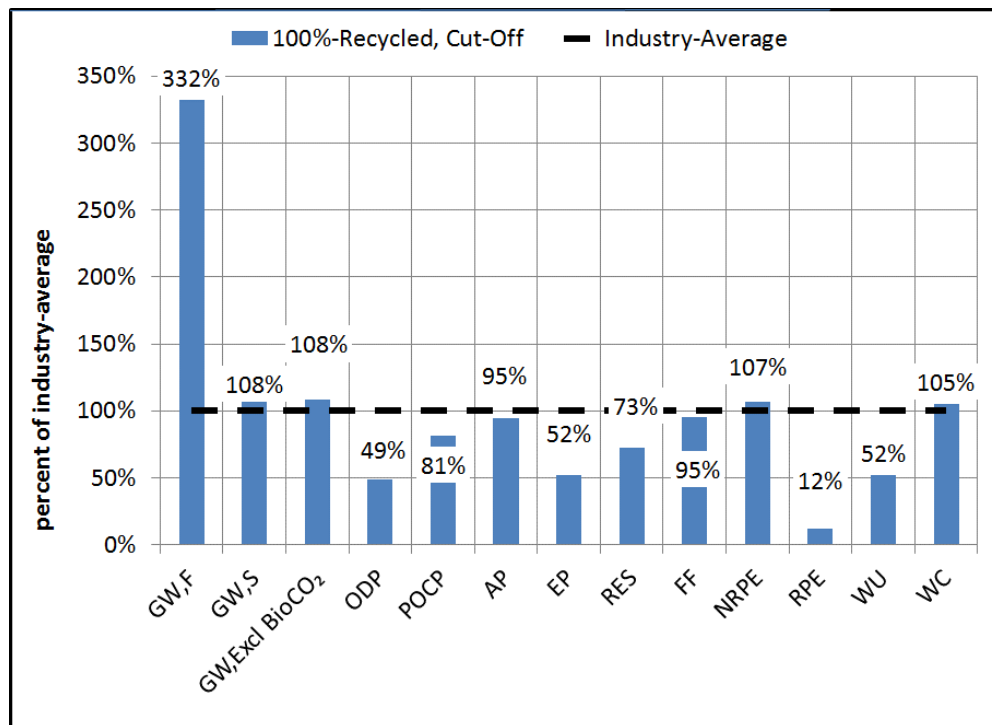

Figure 40. Impact Scores for the 100%-Recycled Product Relative to that of the Industry-Average Product (Cut-Off Method)

8.2.2.1 Global Warming

As shown in Figure 41, the global warming results are significantly higher for the 100%-recycled product than for the industry-average product when using the flow accounting approach (GW,F) and somewhat higher when using the stocks change accounting approach or when ignoring biomass CO₂.

8. Result and Interpretation: 100%-Recycled vs. Industry-Average

Figure 41 provides more explanation for the difference between the industry-average and 100%-recycled product for the flow accounting approach, primarily:

- 1) There are significantly more removals of CO₂ from the atmosphere associated with the industry-average (due to its consumption of virgin fiber) that are not offset by emissions at the end-of-life because 89.5% the product is recovered for recycling; and
- 2) The 100%-recycled product consumes more purchased energy that is almost fully generated using fossil fuels.

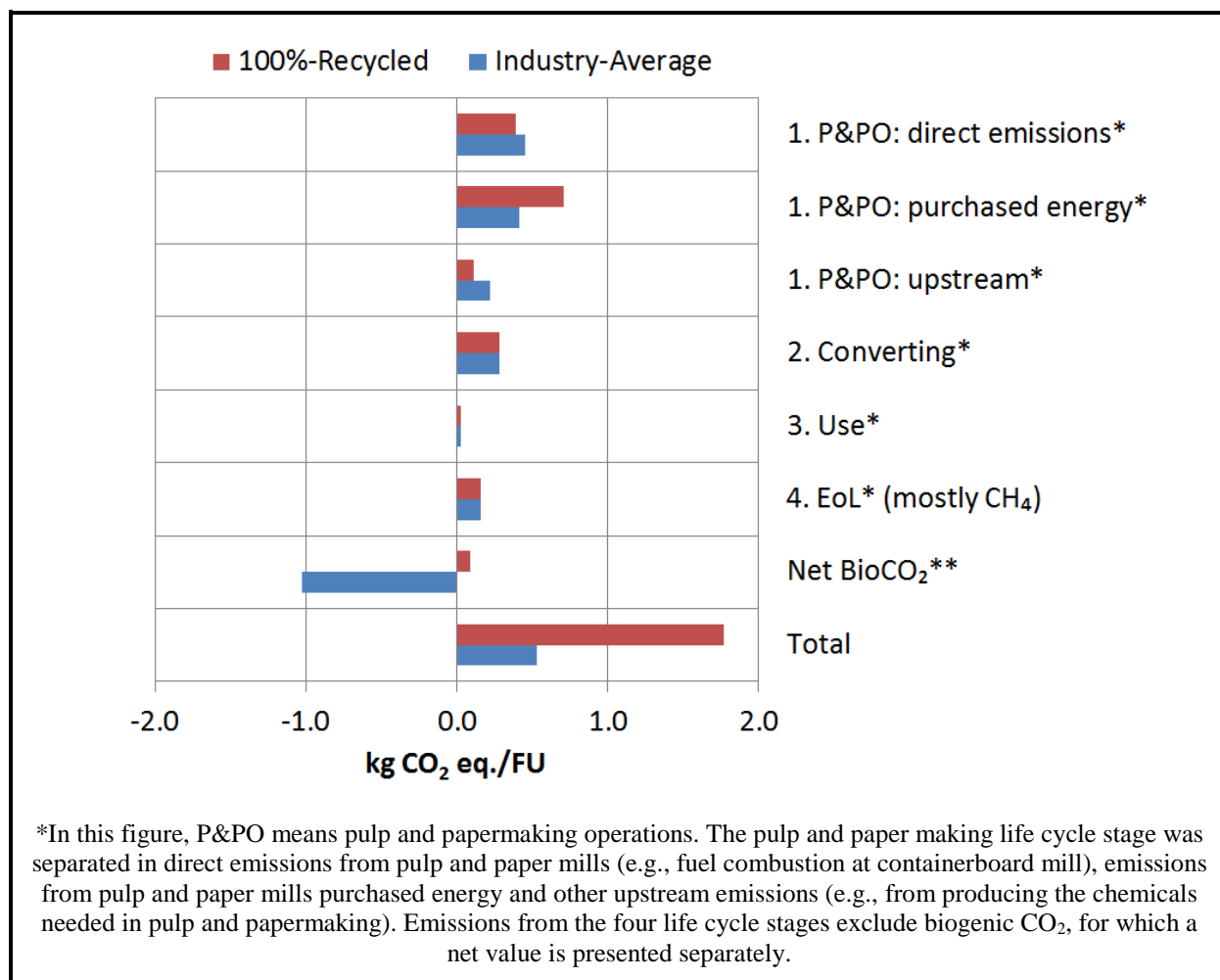

Figure 41. Difference in GHG Emissions between the Industry-Average and 100%-Recycled Corrugated Products (Cut-Off Method)

8.2.2.2 Ozone Depletion (ODP)

The releases of ozone-depleting substances are significantly lower for the 100%-recycled product than for the industry-average product. This is mainly due to greater release of ozone-depleting substances associated with more biofuel combustion in producing the industry-average product.

8.2.2.3 Smog (POCP)

Smog emissions are lower for the 100%-recycled product than for the industry-average product. This is mainly because NO_x emissions are lower at pulp and paper mills that use 100%-recycled fiber than for the industry-average, most likely due to a different fuel mix.

8.2.2.4 Acidification (AP)

The results for the acidification indicator are not significantly different for the 100%-recycled and industry-average products.

8.2.2.5 Eutrophication (EP)

The results for the eutrophication indicator are significantly lower for the 100%-recycled product than for the industry-average product. The main explanation is that NO_x emissions to air and phosphorus releases to water are significantly lower at pulp and paper mills that use 100%-recycled fiber. Note, however, that phosphorus releases from pulp and paper mills are very uncertain for both the industry-average and 100%-recycled products. The effect of this uncertainty is discussed later.

8.2.2.6 Fossil Fuel Depletion (FF), Non-Renewable Primary Energy Demand (NRPE), and Renewable Energy Demand (RPE)

The difference in fossil fuel depletion and non-renewable energy demand between the industry-average and 100%-recycled product is less than 10%. However, the 100%-recycled product consumes significantly less renewable energy than the industry-average. Overall, the 100%-recycled product consumes less total energy than the industry-average.

8.2.2.7 Respiratory Effects (RES)

The results for the respiratory effects indicator are significantly lower for the 100%-recycled than for the industry-average product.

8.2.2.8 Water Use (WU) and Water Consumption (WC)

Water use is significantly lower for the 100%-recycled product than for the industry-average product. This is mainly because pulp and papermaking using recycled fiber requires less water than using virgin fiber. However, water consumption is not significantly different for the two products. Water consumption does go up as a percentage of the intake as water use goes down. Water consumption will also increase on a volumetric basis as water use goes down because temperature management issues become more important.

8.2.3 Sensitivity Analysis

This section presents results of sensitivity analyses that have been performed on: (a) parameters that contribute significantly to the results and have significant uncertainty associated with them, and (b) methodological choices with potential effects on the results. Sensitivity analyses were performed on the following aspects:

8. Result and Interpretation: 100%-Recycled vs. Industry-Average

- LCIA method;
- accounting approach for biogenic CO₂;
- board mix;
- electricity mix for 100%-recycled linerboard and medium; and
- under-representativeness of the 100%-Recycled corrugating medium in the collected data.

Results of these sensitivity analyses are discussed in the following paragraphs.

8.2.3.1 LCIA Method

Figure 42 compares the results obtained using the TRACI and CML methods for the acidification (AP), eutrophication (EP) and smog (POCP) indicators. This figure shows that the choice of the method does not change the conclusion of the comparison.

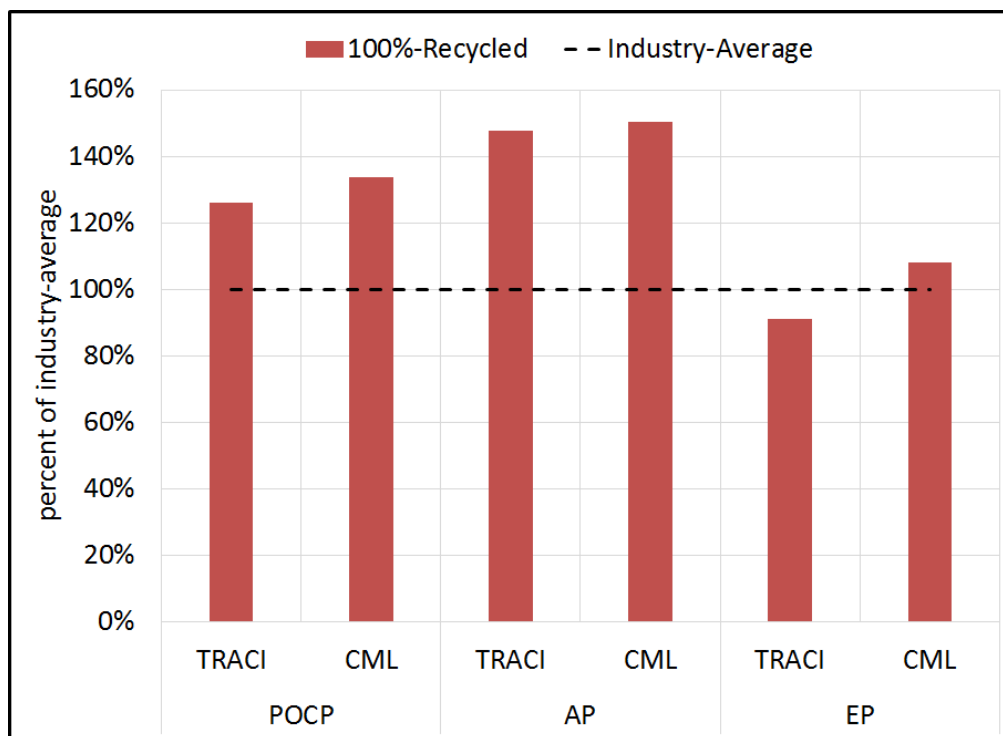

Figure 42. Results for the 100%-Recycled Product Relative to that of the Industry-Average Product: TRACI vs. CML (Cut-Off)

8.2.3.2 Accounting Approach for Biogenic CO₂

The effect of the accounting approach used for biogenic CO₂ on the global warming indicator results was presented in Figure 40. When using flow accounting, the 100%-recycled product has a score for the global warming indicator that is 332% that of the industry-average, whereas the score is approximately 108% of the industry-average score when using stock change accounting or when ignoring biogenic CO₂. This shows that, although the magnitude of the difference between 100%-recycled and industry average varies significantly depending on the method used, the industry-average product always results in lower global warming impact.

8.2.4 Proportion of Each Individual Board Type in the Production Mix

When comparing the 100%-recycled product to the industry-average product, the ratio of linerboard to medium was kept constant, representing the fairest approach because the same product mix is compared. Another approach could have been to compare the actual industry-average corrugated product produced and used in the U.S. to the actual 100%-recycled corrugated product produced and used in the U.S (based on data from AF&PA). As shown in Table 40 above, this affects the ratio of linerboard and medium in the corrugated product. While the industry-average product produced and used in the U.S. is made of 66.8% linerboard and 33.2% corrugated medium, the 100%-recycled product produced and used in the U.S. is made of 52.8% and 47.2% corrugated medium, indicating a difference in exports of the different containerboard components.

Figure 43 shows that the board mix does not significantly affect the results. This is because 100%-recycled linerboard and 100%-recycled medium have very similar environmental performance. From converting to end-of-life, they are assumed to have the same environmental profile. The production of 100%-recycled linerboard and 100%-recycled medium use similar quantities of fiber and of energy. Other aspects that differs between the two products such as chemical and additive usage are not very significant for the overall environmental performance of the two products. With few exceptions, recycled linerboard and recycled medium are produced at the same facilities. The most straightforward method for a mill to allocate environmental load to the two products would be to use mass allocation, which would result in the same environmental profile for the two products on a mass basis.

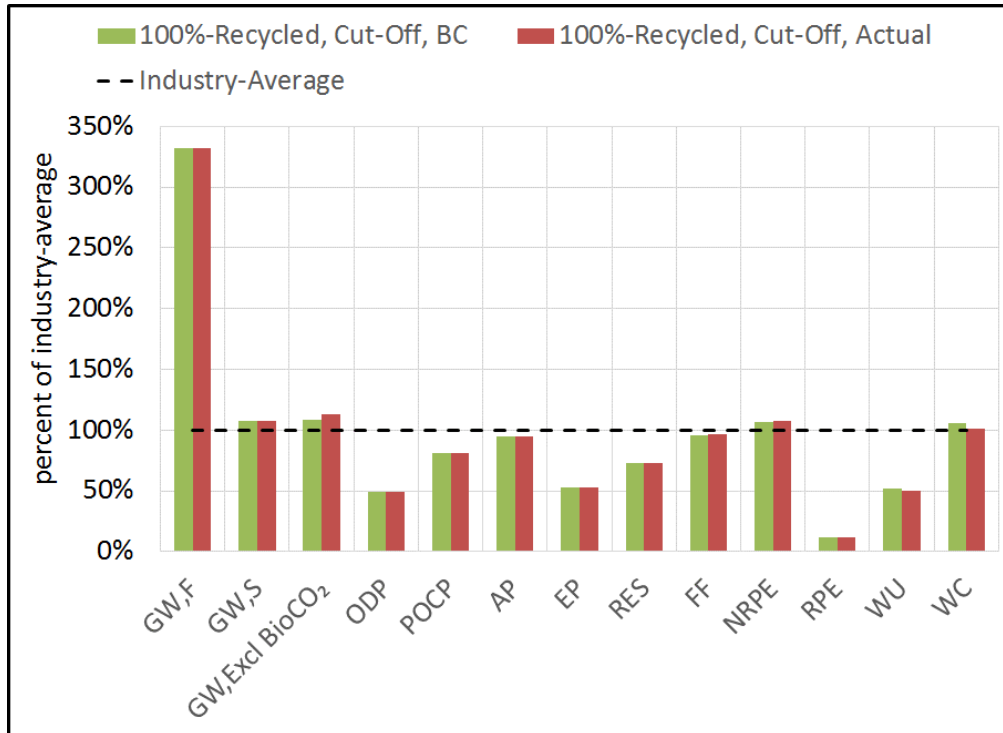

Figure 43. Effect of Board Mix on the Comparison of 100%-Recycled and Industry-Average Products (Cut-Off Method)

8.2.4.1 Electricity Mix for 100%-Recycled Linerboard and Medium

The data collected for 100%-recycled linerboard and medium was exclusively from eastern U.S. states. One effect of this is to skew the impact of the electricity mix modeled in the study. This sensitivity analysis assesses the effect of assuming the same electricity mix for 100%-recycled linerboard and medium as in 2010. As illustrated in Figure 44, this has little effect on the results.

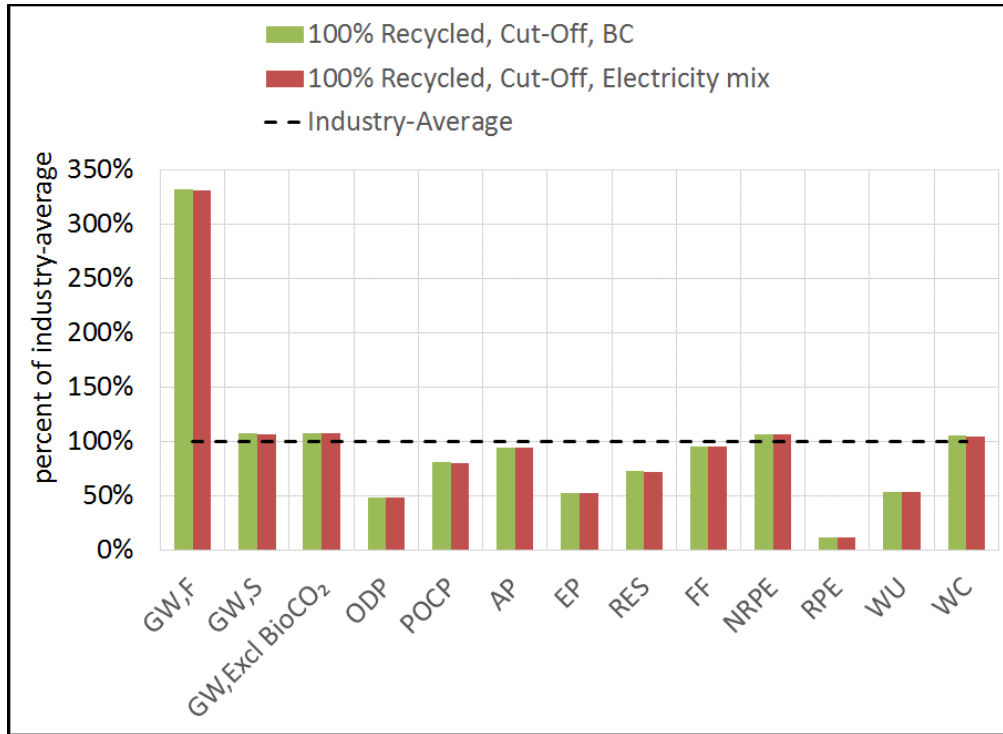

Figure 44. Effect of Electricity Mix on the Comparison of 100%-Recycled and Industry-Average Products (Cut-Off Method)

8.2.4.2 Under-Representativeness of the 100%-Recycled Corrugating Medium in the Collected Data

One of the main limitations regarding the comparison of the industry-average and 100%-recycled products concerns the relatively low coverage of U.S. industry production of 100%-recycled medium represented by the mills providing data (only 40%). It was assumed that the data provided by these mills were representative of recycled medium production in the U.S. A sensitivity analysis was performed assuming the 100%-recycled corrugating medium not represented in the collected data performed (1) 50% worse than, and (2) 50% better than the represented 100%-recycled corrugating medium. A 50% difference was selected based on professional judgment, with the intent of examining a large difference from the average. Results show (Figure 45) that the under-representativeness of corrugating medium is not expected to have significant effect on the results of the comparison of the industry-average and 100%-recycled products.

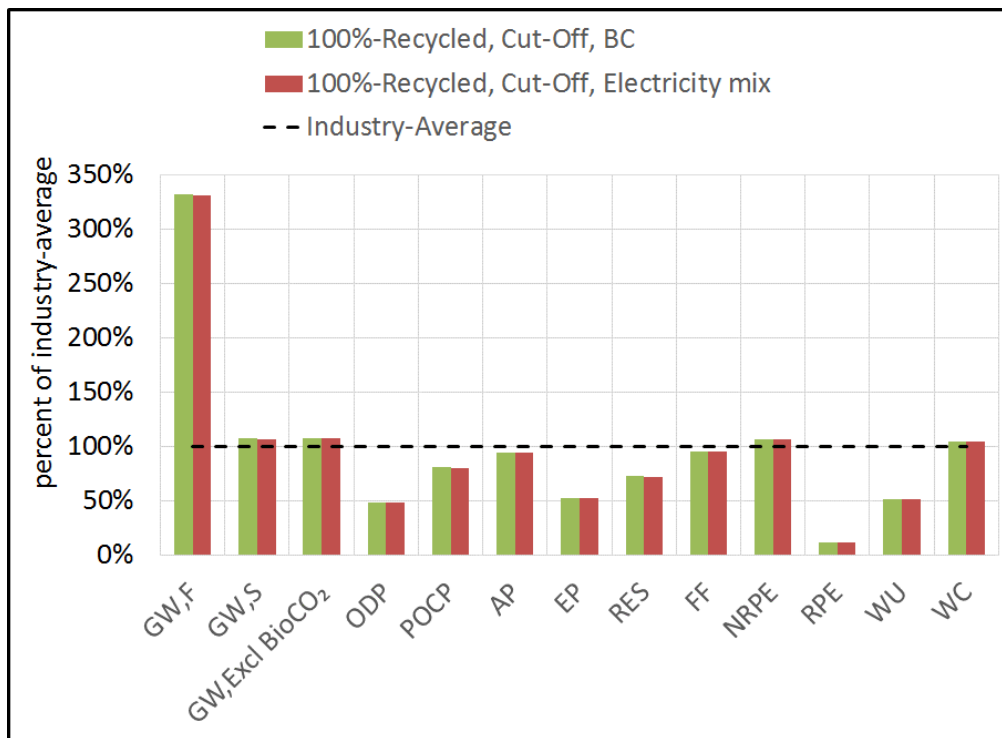

Figure 45. Sensitivity Analysis on the Potential Effect of Having 100%-Recycled Medium Under-Represented in the Collected Data (Cut-Off Method)

8.3 Summary

Table 43 presents a summary of the results obtained for the evaluation of the environmental performance of the 100%-recycled product relative to that of the industry-average product. The results in the table reflect the following interpretations:

- For a given allocation method and a specific environmental indicator, a product was considered as having a lower score if its environmental score was lower than the other product's score by at least 10%.
- For a specific environmental indicator, a product was considered to have a lower environmental score overall if its score was lower, by both allocation methods, than the other product's score by at least 10%.
- For a specific environmental indicator, a product was considered to "probably" have a lower environmental score if its score was lower, by both allocation methods, than the other product's score by less than 10%.

The industry-average product shows a lower environmental score for the global warming indicator (flow accounting) and probably shows a lower environmental score for the other global warming indicators, non-renewable energy consumption and water consumption.

The 100%-recycled product shows a lower environmental score for the renewable energy and water use indicators and probably a lower environmental score for the eutrophication indicator.

8. Result and Interpretation: 100%-Recycled vs. Industry-Average

The results of comparing the industry-average and 100%-recycled products strongly depend on the allocation method for the ozone depletion, smog, acidification, respiratory effects and fossil fuel depletion indicators.

Table 43. Environmental Indicator Results for the 100%-Recycled Product Relative to that of the Industry-Average Product Given Two Allocation Methods for Recycling

Impact Indicator	Product with the Lower Environmental Indicator Result		
	Number of Uses Method	Cut-Off Method	Overall
Global warming, flow accounting	Industry-average	Industry-average	Industry-average
Global warming, stock change accounting	Industry-average	No significant difference observed	Probably industry-average
Global warming, excluding biogenic CO ₂	Industry-average	No significant difference observed	Probably industry-average
Global warming, all indicators	Industry-average	Depends on the indicator	Probably industry-average
Ozone depletion	No significant difference observed	100%-recycled	Depends on the method
Smog	Industry-average	100%-recycled	Depends on the method
Acidification	Industry-average	No significant differences observed	Depends on the method
Eutrophication	No significant difference observed	100%-recycled	Probably 100%-recycled
Respiratory effects	Industry-average	100%-recycled	Depends on the method
Fossil fuel depletion	Industry-average	No significant differences observed	Depends on the method
Non-renewable primary energy demand	Industry-average	No significant differences observed	Probably industry-average
Renewable primary energy demand	100%-recycled	100%-recycled	100%-recycled
Water use	100%-recycled	100%-recycled	100%-recycled
Water consumption	Industry-average	No significant differences observed	Probably industry-average

9. EVALUATION

The evaluation phase of a LCA is intended to establish confidence in the results of the life cycle assessment. It normally includes a sensitivity check, completeness check and consistency check and can be supplemented with uncertainty and data quality analyses.

9.1 Sensitivity Check

Sensitivity analyses were performed for the three main objectives of this project and the results were presented in previous sections.

9.2 Completeness and Consistency Checks

The completeness check is the *"process of verifying whether information from the phases of a life cycle assessment is sufficient for reaching conclusions in accordance with the goal and scope definition"* and the consistency check is the *"process of verifying that the assumptions, methods and data are consistently applied throughout the study and are in accordance with the goal and scope definition performed before conclusions are reached."* (ISO 2006b, p. 6).

In this study, most assumptions and methodological choices have been applied consistently. Sensitivity analyses were performed on methodological choices, on the parameters with relatively large uncertainty, and on potential inconsistencies. These allowed clear definition of the conditions for which the main conclusions remain valid. Hence, consistency in modeling systems in the study is considered sufficient to achieve the objectives. There were no significant data gaps, and hence the completeness of the study is considered adequate in relation to its objectives.

9.3 Uncertainty Analysis

No formal quantitative uncertainty analysis was performed in this study. However, uncertainty is important in understanding the significance of the results obtained, especially when comparisons are performed. For this reason, a qualitative analysis was undertaken. Any difference lower than 10% is unlikely to be significant (Franklin Associates 2004, Humbert et al. 2009, NCASI 2010). These differences were depicted for results of the comparison of the 2006 and 2010 environmental performance as well as for the comparison of 100%-recycled and industry-average products using gray bars on figures in previous sections. The results are summarized below.

9.3.1 2014 vs. 2010

The differences observed for the global warming, ozone depletion, smog, acidification eutrophication, non-renewable energy, fossil fuel depletion, renewable energy demand and water consumption indicators fall below the 10% threshold. This indicates that, for these indicators, the differences observed between 2014 and 2014 are not considered meaningful. However, reductions considered meaningful were observed for the respiratory effects (-12%) and water use (-10%) indicators.

9.3.2 100%-Recycled vs. Industry-Average

9.3.2.1 Number of Uses Method

Based on the uncertainty analysis only, the significance of the differences observed between industry-average and 100%-recycled products was not significant for the ozone depletion and eutrophication indicators (see Figure 31).

9.3.2.2 Cut-Off Method

Based on the uncertainty analysis only, the significance of the differences observed between industry-average and 100%-recycled products was not significant for the global warming (stock change accounting and excluding biogenic CO₂), acidification, fossil fuel depletion, non-renewable energy and water consumption indicators (see Figure 40).

9.4 Data Quality Analysis

The results of the data quality analysis were presented in the inventory phase of this LCA (see Section 4.4).

10. CONCLUSIONS

This study represents a comprehensive LCA of a 2014 U.S. industry-average corrugated product. The main conclusions that can be drawn from the study are discussed here.

10.1 2014 Industry-Average

Pulp and papermaking production (containerboard) is the main driver of the life cycle environmental performance. For all impact categories, material and energy flows from paper mills dominate the results (positively or negatively). Environmental impacts are dominated by energy demands at the mill. Bio-based energy (e.g., hog-fuel, liquor, etc.) substantially reduces the global warming contribution from mills. Converting facilities also contribute relatively significantly to most impact categories.

End-of-Life is only significant with respect to the global warming indicator results. Other life-cycle impact indicators show little or no response from the end-of-life stage. The global warming potential observed at end-of-life is mainly due to methane released from landfill operations. Sensitivity analyses clearly showed that increasing the recovery rate has the potential to improve overall environmental performance.

The global warming indicator results are highly dependent on the accounting method for biogenic CO₂. Two different accounting approaches can be used to compute the results for the global warming indicator: flow accounting, which was the main method employed in this study, and stock accounting, which was examined in a sensitivity analysis. Flow accounting is the accounting method the most used in LCA studies. Stock change accounting is mostly used in national inventories. Another approach sometimes used in LCA is simply ignoring biogenic CO₂ when calculating the global warming indicator results to get an understanding of how non-biogenic CO₂ GHG contribute to the global warming indicator. Note that this approach ignores any removal/storage of biogenic carbon. The effect on the global warming indicator of applying one of approach versus the other was very significant. The pulp and papermaking operations life cycle went from a being an insignificant contributor to global warming when applying the flow accounting approach to a very significant contributor when applying the stock change method or ignoring biogenic CO₂. When applying the stock change accounting approach or ignoring biogenic CO₂, the contribution of end-of-life to the overall global warming results was reduced compared to when applying the flow accounting method.

10.2 2014 vs. 2010

Overall, the life cycle environmental performance was about stable between 2010 and 2014. However, significant improvements were observed for the respiratory effects (particulates) and water use indicators. The main drivers for the reduction in particulate release is the increased share of natural gas in the containerboard mills energy mix. The reduction in water use is mainly due to an increase in recycled content. The study also showed a significant increase in the fossil fuel indicator, mainly due to increase share in natural gas in the containerboard fuel mix and increase used of natural gas by converting facilities.

The sensitivity analysis found that the changes in performance between 2010 and 2014 calculated in the study were affected in magnitude by the parameters examined in the sensitivity analysis but not in direction, indicating that the results are robust for most environmental indicators. An exception is the global warming indicator that can be sensitive to the share of all other linerboard in the board mix. The board mix for containerboard produced and used in the U.S. was estimated based on various sources of information. Errors in the mix could have significant effects on the global warming results.

10.3 100%-Recycled vs. Industry-Average

The results of comparisons of the industry average product to 100%-recycled product varied by indicator, with some results being strongly dependent on the allocation method chosen for recycling.

In summary, the industry-average indicator results were lower for the global warming, acidification and non-renewable energy indicators regardless of the allocation method used, although for the non-renewable indicator the results obtained with the cut-off allocation method showed that the difference between the two products was not significant. Results also suggest that the 100%-recycled product generates lower emissions of eutrophying substance and uses less water and renewable energy than the industry-average, although for the eutrophication indicator the results obtained with the Number of Uses allocation method showed that the difference between the two products was not significant. The results for the other environmental indicators (i.e., ozone depletion, smog, eutrophication, respiratory effects, fossil fuel depletion) depend on the allocation method.

Although 100%-recycled corrugated medium production was under-represented by the survey data used in the study, a sensitivity analysis showed that this was unlikely to affect the general findings described above.

11. CRITICAL REVIEW

A critical review was undertaken for this study to ensure it is completed to the requirements of ISO 14040 Series Standards and industry best practices. Some aspects of this study are comparative, making the peer review even more critical. However, because the study was essentially a repetition of one undertaken in previous years, only one person reviewed it. Lindita Bushi from the Athena Sustainable Materials Institute was commissioned to undertake the critical review in accordance with ISO 14040/44 (2006).

The review process consisted of the following steps:

1. Review and comment on the draft final report;
2. Discuss issues with study CPA and NCASI; and
3. Review of the updated final report.

The details of the final peer review can be found on the next page and the details in Appendix K.

Mr. Brian O'Banion
Fibre Box Association
500 Park Blvd., Suite 985
Itasca, IL 60143
www.fibrebox.org

May 23rd, 2017

RE: Critical Review of 2014 U.S. Average Corrugated Product LCA Report by External Expert

Introduction

The Athena Sustainable Materials Institute (www.athenasmi.org) was engaged to perform a third-party review of the 2014 U.S. Average Corrugated Product LCA report conducted by National Council for Air and Stream Improvement, Inc. (NCASI) in 2017 as commissioned by Corrugated Packaging Alliance (CPA).

The review was conducted by Dr. Lindita Bushi, Senior Research Associate, Athena Sustainable Materials Institute. Dr. Bushi reviewed the first draft and the final version of the LCA report from May 23rd, 2017 in accordance with:

- International Organization of Standardization (ISO) 14044:2006 Environmental Management—Life Cycle Assessment—Requirements and Guidelines, Clause 6 Critical review.
- ISO 14040:2006 Environmental Management—Life Cycle Assessment—Principles and Framework, Clause 7 Critical review.

The reviewer confirms the following,

- The industry specific data, as presented in the LCA report, has been examined regarding plausibility and consistency;
- She has sufficient knowledge and experience of the corrugated packaging products, pulp and paper industry, relevant standards and the geographical area of the LCA to carry out this review; and
- She has been independent in her role as reviewer in accordance with the ISO 14044 requirements, and has no conflicts of interest regarding this review.

Critical Review Objectives

Per ISO 14044:2006, the critical review process included the following criteria to ensure conformance with applicable standards:

- Are methods used to carry out the LCA consistent with ISO 14040/14044 standards?
- Are methods used to carry out the LCA scientifically and technically valid?
- Are data used appropriate and reasonable in relation to the goal of the study?
- Do interpretations reflected the limitations identified and the goal of the study?
- Is the study report transparent and consistent?

Review Results

As per the critical review objectives, the reviewer concludes that the 2014 U.S. Average Corrugated Product LCA study conforms to the applicable ISO 14040/14044 standards as a comprehensive study that may be disclosed to the public.

A copy of the review report, including Annex A *LCA report Checklist* and *Review Matrix from May 23rd, 2017 (9 pp.)*, is provided to the CPA and NCASI. As per ISO 14044, Clause 6.2, this review report shall be made available to any interested party upon the request.

The reviewer appreciates the professional responsiveness of NCASI LCA team to all technical queries and comments and that of all parties involved in the review process.

Respectfully,

Name and organization of external reviewer: Lindita Bushi, Ph.D., LEED Green Associate Athena Sustainable Materials Institute D: 416 269 8571 E: lindita.bushi@athenasmi.org	Address: 119 Ross Avenue, Suite 100 Ottawa, Ontario, Canada K1Y 0N6 http://www.athenasmi.org
--	---

5/23/2017

X *Lindita Bushi*

Lindita Bushi

Signed by: Lindita Bushi

APPENDICES

A. DISCUSSION OF ISO 14044 OPTIONS FOR ALLOCATION

In this appendix, the general recommendations of the ISO 14044 Standard on LCA (ISO 2006b, p. 14) regarding co-product and open-loop recycling allocation are summarized. The ISO 14044 Standard specifies the following requirements for all allocation situations.

“The inputs and outputs shall be allocated to the different products according to clearly stated procedures that shall be documented and explained together with the allocation procedure.

The sum of the allocated inputs and outputs of a unit process shall be equal to the inputs and outputs of the unit process before allocation.²²

Whenever several alternative allocation procedures seem applicable, a sensitivity analysis shall be conducted to illustrate the consequences of the departure from the selected approach.

Allocation procedures shall be uniformly applied to similar inputs and outputs of the system under consideration. For example, if allocation is made to usable products (e.g., intermediate or discarded products) leaving the system, then the allocation procedure shall be similar to the allocation procedure used for such products entering the system.”

This last requirement means that the same allocation procedure shall be applied to both the production and use of recovered fiber.

The ISO Standard proposes different strategies that can be used to resolve co-product and recycling allocation problems. These are discussed below.

A.1 Co-Product Allocation

The ISO 14044 Standard on LCA (ISO 2006b) provides the following hierarchy of strategies for co-products :

- 1) Avoid allocation through
 - a. System subdivision, or
 - b. System expansion,
- 2) Perform allocation using an underlying physical relationship, and
- 3) Perform allocation using another relationship.

Strictly speaking, the hierarchy in the ISO 14044 Standard requires that, whenever possible, system subdivision and expansion strategies must be selected. Practically speaking, the selection of an adequate approach depends on the goal of the study, the available data and information, and the type of the shared process to be allocated (Ekvall and Weidema 2004, European Commission - Joint Research Centre - Institute for Environment and Sustainability (EC-JRC-IES) 2010, Tillman 2000, Werner 2005b). The LCA ISO series (International Organization for

²² This is often referred to as the modularity requirement.

Standardization (ISO) 2006a, b) also recognizes that the decision context and the intended application should be considered when defining the product system studied but has been criticized for not accounting for various application approaches in its allocation hierarchy (Ekvall and Finnveden 2001, Ekvall and Tillman 1997, Ekvall and Weidema 2004, Werner 2005b).

A.2 Recycling

The ISO 14044 Standard (International Organization for Standardization (ISO) 2006b) specifies that the hierarchy for co-product allocation also applies to recycling, especially for the recovery processes. However, additional elaboration may be required because recycling “*may imply that the inputs and outputs associated with unit processes for **extraction and processing of raw materials and final disposal of products** are to be shared by more than one product system*” (International Organization for Standardization (ISO) 2006b). In other words, the recovery processes are not the only processes shared between different product systems. Another reason for recycling allocation to potentially require additional elaboration is that it “*may change the inherent properties of materials in subsequent use*” (International Organization for Standardization (ISO) 2006b).

Several allocation approaches can be applied to open-loop recycling. As mentioned, the first approach in the ISO 14044 hierarchy for co-products is to avoid allocation by dividing or expanding the system boundaries. Another way to avoid allocation, in a manner that is specific to recycling allocation problems, is to approximate an open-loop system with a closed-loop system. In doing so, it is assumed that the use of recovered material displaces the use of virgin materials. The ISO Standard allows for this only in cases “*where no changes occur in the inherent properties of the recycled material*²³” (International Organization for Standardization (ISO) 2006b).

In cases where allocation cannot be avoided, the ISO Standard (International Organization for Standardization (ISO) 2006b) recommends application of an allocation procedure for the shared unit processes that use, in order of preference, the following as the basis for allocation, where feasible:

- Physical properties (e.g., mass);
- Economic value (e.g., market value of the scrap material or recycled recovered in relation to market value of primary material); or
- Number of subsequent uses of the recovered material.

A.3 Relation between the Study Objective and the Choice of an Allocation Strategy

The LCA ISO series (ISO 2006a, b) also recognizes that the decision context and the intended application should be considered when defining the product system studied and mentions two application approaches for LCA that have been developed in recent years:

²³ The ISO Standard uses the term “recycled material” to designate a type of secondary raw material. This terminology can be confusing. Hence, in this document, “recovered material” will be used instead.

- 1) “one which assigns elementary flows and potential environmental impacts to a specific product system typically as an account of the history of the product, and
- 2) one which studies the environmental consequences of possible (future) changes between alternative product systems.”

These have been called Accounting LCA and Change-Oriented LCA, respectively, along with a variety of other monikers. Although the ISO 14044 Standard recognizes that “the scope, including system boundary and level of detail, of a LCA depends on the subject and the intended use of the study,” it does not provide any guidance on how the allocation hierarchy should be adapted in this context. In the literature, there is general agreement that system subdivision always applies but that system expansion is better suited to change-oriented LCAs (e.g., Baumann 1996, Baumann and Tillman 2004, Ekvall 1999, Ekvall et al. 2005, Ekvall and Weidema 2004, Werner 2005a).

B. CARBON CONTENT AND MASS BALANCES

B.1 Carbon Contents

This section summarizes the calculation of carbon contents for containerboard and corrugated products.

B.1.1 Containerboard

The carbon content of 2014 industry-average containerboard ($CC_{CB,IA}$) was estimated as follows:

$$CC_{CB,IA} = (1 - F_{PA,IA}) \times CC_F + Q_{St,CB,IA} \times CC_{St} = (1 - 0.0130) \times 0.5 + 0.0049 \times 0.444 \\ = 0.496 \text{ kg/kg}$$

Where $F_{PA,IA}$ is the fraction of the total mass of containerboard that is from papermaking additives in 2014 industry-average containerboard (aluminum sulfate, strength agent, starch and other fillers); CC_F is the carbon content of fiber, $Q_{St,CB,IA}$, the quantity of starch in 2014 industry-average containerboard; and CC_{St} is the carbon content of starch. Carbon in other additives was neglected. All units are kg per kg of containerboard.

Similarly, it was possible to calculate the carbon content of 100%-recycled containerboard ($CC_{CB,REC}$):

$$CC_{CB,REC} = (1 - F_{PA,REC}) \times CC_F + Q_{St,CB,REC} \times CC_{St} = (1 - 0.00904) \times 0.5 + 0.0055 \times 0.444 \\ = 0.498 \text{ kg/kg}$$

Where $F_{PA,REC}$ is the fraction of the total mass of containerboard that is from papermaking additives in 100%-recycled containerboard (aluminum sulfate, calcium carbonate, sizing agent, soda, sodium carbonate, strength agents, retention aids, etc.); CC_F is the carbon content of fiber; $Q_{St,CB,REC}$ is the quantity of starch in 100%-recycled containerboard; and CC_{St} is the carbon content of starch. Carbon in other additives was neglected. All units are kg per kg of containerboard.

Difference in carbon contents between 2006 and 2010 were neglected because most additives were set equal between 2006 and 2010.

B.1.2 Corrugated Product

A carbon balance, illustrated in Figure 46, was used to calculate the carbon content of the 2014 corrugated product ($CC_{CP,2014}$):

$$Q_{CB,IA} \times CC_{CB,IA} + Q_{St,CP} \times CC_{St} = Q_{CP,2014} \times CC_{CP,2014} + Q_L \times CC_L \\ = Q_{CP,2014} \times CC_{CP,2014} + Q_L \times CC_{CP,2014}$$

$$CC_{CP,IA} = \frac{Q_{CB,IA} \times CC_{CB,IA} + Q_{St,CP} \times CC_{St}}{Q_{CP,2014} + Q_L} = \frac{1.10 \times 0.496 + 0.016 \times 0.444}{1 + 0.125} = 0.491 \text{ kg/kg}$$

Where $Q_{CB,IA}$ is the quantity of 2014 industry-average containerboard (in kg/kg); $CC_{CB,IA}$ is the carbon content of the 2014 industry-average containerboard; $Q_{St,CP}$ is the quantity of starch used in 2014 industry-average corrugated product; CC_{St} is the carbon content of starch; $Q_{CP,2014}$ is the quantity of 2010 corrugated product; Q_L is the quantity of converting losses; and CC_L is the carbon content of losses. Converting losses are a mixture of unconverted containerboard and trimming from corrugated product, but are mostly made of the latter. For this reason, it was assumed that the carbon content of losses was the same as that of the corrugated product (i.e., $CC_L = CC_{CP,2014}$). Carbon in other additives was neglected. All units are kg per kg of containerboard.

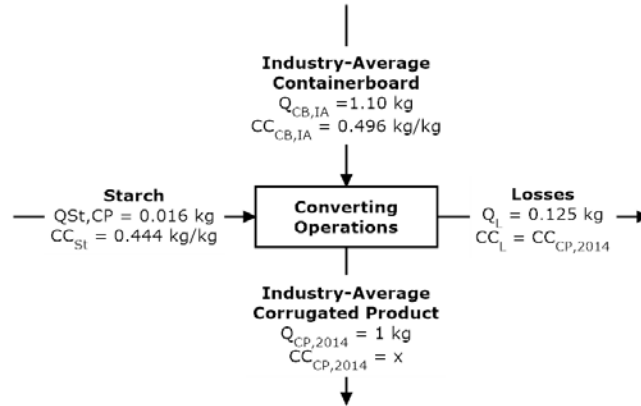

Figure 46. Carbon Balance on Converting Operations (2014 Industry-Average)

B.2 Mass Balances

Three types of mass balance checks were performed: a fiber balance check, a carbon balance check and a water balance check.

B.2.1 2014 Industry-Average Containerboard

First, it was verified using standard yield values that the quantity of fiber was sufficient for manufacturing the quantity of pulp reported by the mills. As illustrated in Table 44, the fiber input falls within the expected range.

Table 44. Fiber Balance for the 2014 Industry-Average Containerboard Production

Fiber material	Quantity of fiber (kg/kg CP)	Typical yield (kg pulp/kg fiber)	Quantity of pulp/product (kg)
Pulpwood*	1.02	0.53 (0.49-0.67)**	0.54 (0.50-0.69)
Recovered fiber	0.57	0.90 (0.85-0.95)	0.52 (0.49-0.55)
<i>Total pulp, calculated (kg/kg CP)</i>			<i>1.05 (0.99-1.23)</i>
<i>Total pulp, reported (kg/kg CP)</i>			<i>1.10</i>
<i>Discrepancy [(calculated-reported)/reported]</i>			<i>-4.6% (-10% to 12%)</i>

*Chips and logs not including self-generated hogged fuel from manufacturing residues. **Estimated weighted average of kraft (0.485) and semichemical (0.70).

Second, the carbon balance was checked, as depicted in Table 45. This table shows a 1.4% difference between outputs and inputs of carbon. This difference may be due to:

- Smaller sources of carbon emissions that were computed in the model but not in Table 45 (e.g., carbon stored in mill landfills, carbon emitted in something other than CO₂, etc.);
- Imprecision in some of the carbon contents (i.e., recovered pulp, recovered fiber, WWTP residuals, and black liquor);
- Carbon content in other wastes; or
- Real discrepancies in the data collected.

To be conservative, the carbon balance was forced to close by increasing the releases. NCASI used professional judgment to increase the quantity of disposed residuals and carbon content of black liquor (and hence related releases):

- The average quantity of residuals being disposed of was increased from 0.074 to 0.088 kg/kg CP, making the carbon from residuals increase from 0.036 to 0.043 kg/kg CP. This was achieved by increasing the quantity of WWTP residuals sent to disposal but keeping constant the WWTP residuals burned for energy. Changes were applied only to the 100%-recycled board components. The average quantity of WWTP residuals being disposed of was increased from 0.023 to 0.036 kg/kg CP, making the carbon from total WWTP increase from 0.011 to 0.018 kg/kg CP.
- The remaining discrepancy was fixed by changing the carbon content of black liquor (on average from 35.0% to 35.9%) for all other linerboard and recycled medium. As a result, the carbon emissions from black liquor went from 0.202 kg C/kg CP to 0.208 kg C/kg CP.

Table 45. Carbon Balance for the 2014 Industry-Average Containerboard Production

Carbon Input	Quantity as Obtained through Data Collection and Assumptions		Carbon Output	Quantity as Obtained through Data Collection and Assumptions	
	kg/kg CP	kg C/kg CP		kg/kg CP	kg C/kg CP
Wood inputs (logs and chips)	1.14	0.571	Containerboard	1.10	0.545
Recovered fiber	0.572	0.281	Combustion of self-generated manufacturing hogged fuel	0.122	0.061
Virgin pulp	~0.000	0.000	Combustion of black liquor	0.577	0.202 (0.208)*
Recovered pulp	0.004	0.002	Combustion of hogged fuel other than self-generated manufacturing	0.122	0.061
Hogged fuel, not including self-generated manufacturing	0.134	0.067	Residuals burned for energy or disposed of	0.0739 (0.0875)*	0.0362 (0.0429)*
Starch	0.005	0.002	Total carbon output		0.911 (0.925)*
Total input carbon input		0.925	Discrepancy [(in-out)/out]		1.4%

*Corrected value.

Finally, for containerboard mills, mass balances were used to close the water balance. Data were collected for:

- water intake (aggregated cooling and process);
- effluent (process only);
- water in raw materials; and
- water in product.

The total of cooling water output and evaporation was assumed to be equal to the difference between inputs and outputs of water:

$$\begin{aligned} \text{Difference} &= \text{Cooling water}_{OUT} + \text{Evaporation} \\ &= \text{Water intake} + \text{Water in raw material} - \text{Effluent} - \text{Water in product} \end{aligned}$$

The quantity of water evaporated was estimated using NCASI data (2008, Tables 2.12, 3.6 and 3.10) and the cooling water output was calculated by difference.

B.2.2 2014 100%-Recycled

First, it was verified using standard yield values that the quantity of fiber was sufficient for manufacturing the product. As illustrated in Table 46, the fiber input fell well within the expected range.

Table 46. Fiber Balance for the 100%-Recycled Containerboard Production

Fiber material	Quantity of fiber (kg/kg CP)	Typical yield (kg pulp/kg fiber)	Quantity of pulp/product (kg)
Recovered fiber	1.23	0.90 (0.85-0.95)	1.11 (1.05-1.18)
Purchased pulps	Negligible	1.00	Negligible
<i>Total pulp</i>			1.12 (1.05-1.17)
<i>Total pulp, reported (kg/kg CP)</i>			1.14
<i>Discrepancy [(in-out)/out]</i>			-1.6% (-7.1%-3.9%)

Second, the carbon balance was checked, as depicted in Table 47. This table shows a 3.9% difference between outputs and inputs of carbon. This difference may be due to:

- Smaller sources of carbon emissions that were computed in the model but not in Table 45 (e.g., carbon stored in mill landfills, carbon emitted in something other than CO₂, etc.);
- Imprecision in some of the carbon contents (i.e., recovered pulp, recovered fiber, WWTP residuals, and black liquor);
- Carbon content in other wastes; or
- Real discrepancies in the data collected.

To be conservative, the carbon balance was forced to close by increasing the releases. NCASI used professional judgment to increase the quantity of disposed WWTP residuals and carbon content of black liquor (and hence related releases):

- The average quantity of WWTP residuals being disposed of was increased from 0.017 to 0.064 kg/kg CP, making the carbon from total WWTP increase from 0.008 to 0.032 kg/kg CP. The quantity of WWTP residuals burned for energy was kept constant. Changes were applied only to the 100%-recycled board components.

Table 47. Carbon Balance for the 2014 100%-Recycled Containerboard Production

Carbon Input	Quantity as Obtained through Data Collection and Assumptions		Carbon Output	Quantity as Obtained through Data Collection and Assumptions	
	kg/kg CP	kg C/kg CP		kg/kg CP	kg C/kg CP
Wood inputs (logs and chips)	0.002	0.001	Containerboard	1.10	0.548
Recovered fiber	1.24	0.604	Combustion of self-generated manufacturing hogged fuel	0.004	0.002
Virgin pulp	0	0	Combustion of black liquor	0	0
Recovered pulp	0	0	Combustion of hogged fuel other than self-generated manufacturing	0.030	0.015
Hogged fuel, not including self-generated manufacturing	0.030	0.015	Residuals burned for energy or disposed of	0.0713 (0.119)*	0.0349 (0.0582)*
Starch	0.006	0.003	Total carbon output	0.612 (0.623)*	
Total input carbon input		0.623	Discrepancy [(in-out)/out]		3.9%

†Corrected value.

Finally, for containerboard mills, mass balances were used to close the water balance. Data were collected for:

- water intake (aggregated cooling and process);
- effluent (process only);
- water in raw materials; and
- water in product.

The total of cooling water output plus evaporation was assumed to be equal to the difference between inputs and outputs of water:

$$\begin{aligned} \text{Difference} &= \text{Cooling water}_{OUT} + \text{Evaporation} \\ &= \text{Water intake} + \text{Water in raw material} - \text{Effluent} - \text{Water in product} \end{aligned}$$

The quantity of water evaporated was estimated using NCASI data (2008, Tables 2.12, 3.6 and 3.10) and the cooling water output was calculated by difference.

B.2.3 Converting

Mass balances were also performed for converting facilities, by plant types. For confidentiality reason, these are not presented here. However, data indicated some small discrepancies.

Although the data was accepted from a QA perspective, mass balance errors for converting plants would have a direct effect on the main reference flows and hence on the study results. For this reason, it was decided to correct the mass balance for modeling purposes. A conservative approach was taken, in that the amount of containerboard or sheet input in each of the facility types was increased to close the balance. This approach is also the most aligned with the existing knowledge on typical conversion losses (i.e., between 3 and 10%).

B.2.4 Overall Biogenic Carbon Balances

Figure 47 and Figure 48 present the life cycle carbon balance for the industry-average and 100%-recycled products.

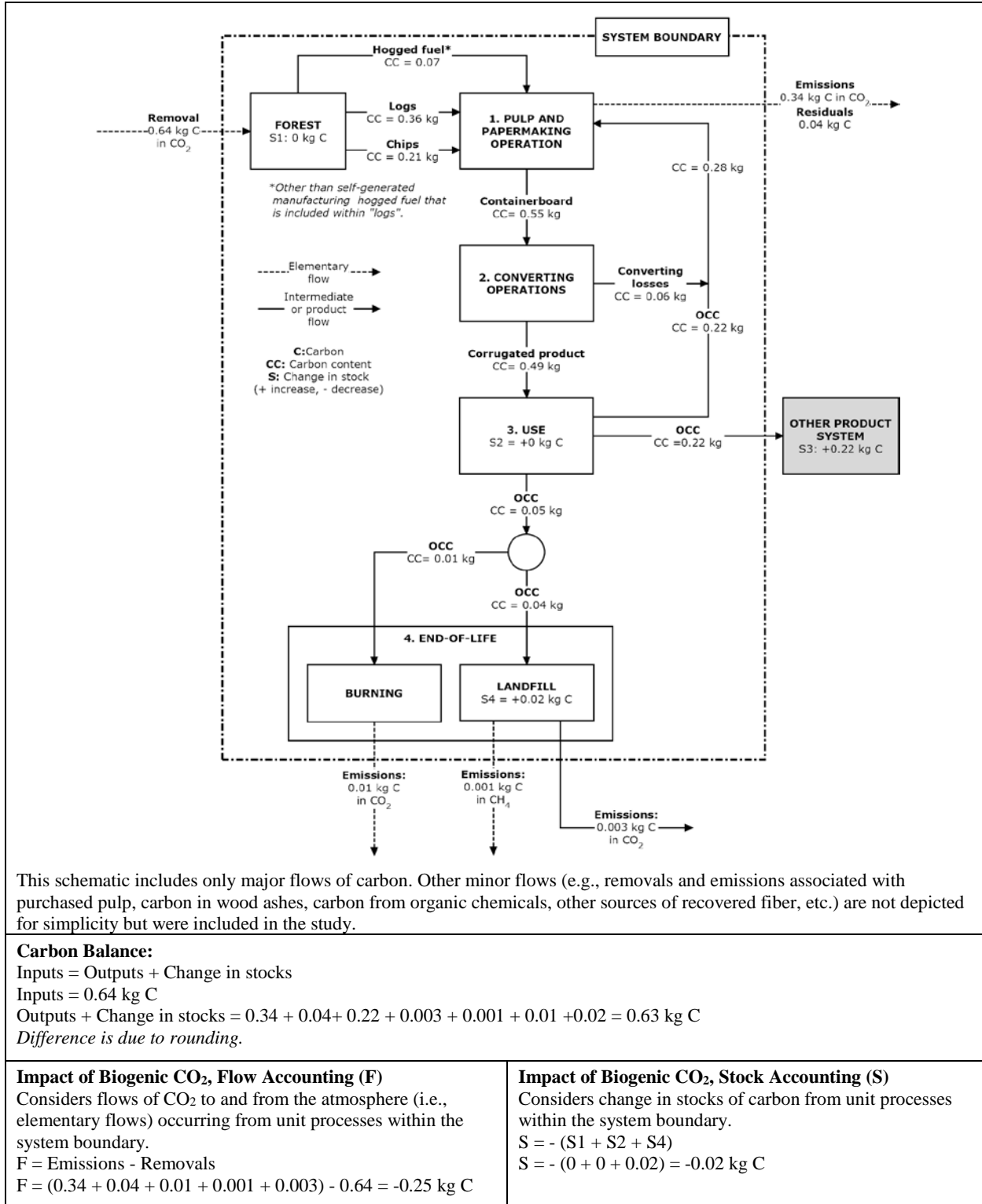
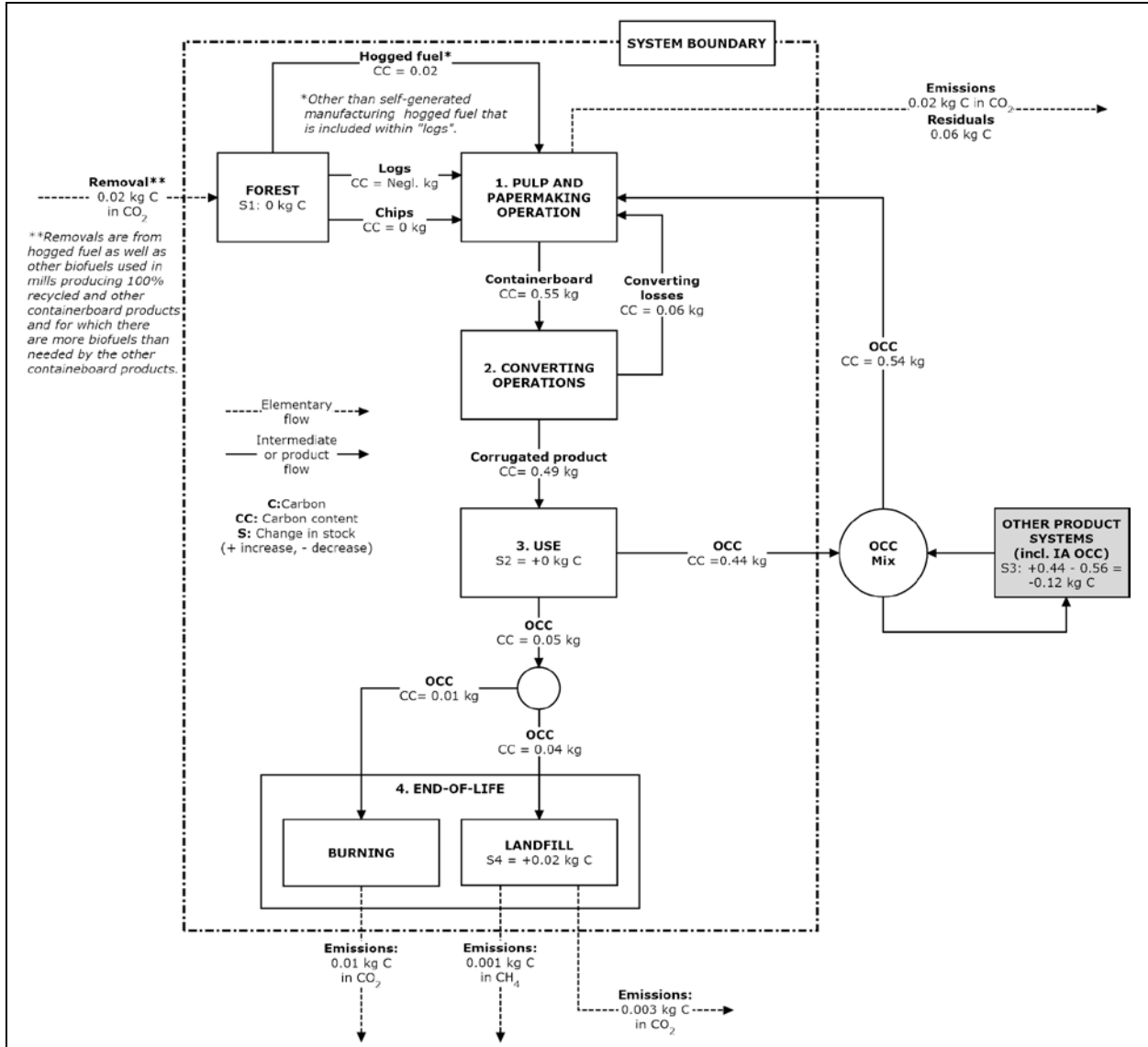

Figure 47. Cradle-to-Grave Carbon Balance: Industry-Average Product



The schematic of biogenic carbon flows across and within the corrugated product system boundary, presented above, is based on the simplifying assumption that all needs of recovered fiber for containerboard production are fulfilled using OCC. The schematic includes only major flows of carbon. Other minor flows (e.g., removals and emissions associated with purchased pulp, carbon in wood ashes, carbon from organic chemicals, etc.) are not depicted for simplicity but were included in the study.

Carbon Balance:

Inputs = Outputs + Change in stocks (within system boundary)
 Inputs = 0.02 + 0.54 = 0.56 kg C
 Outputs + Change in stocks = 0.02 + 0.06 + 0.01 + 0.001 + 0.003 + 0.44 + 0.02 = 0.55 kg C
 Difference is due to rounding.

Impact of Biogenic CO₂, Flow Accounting (F)

Considers flows of CO₂ to and from the atmosphere (i.e., elementary flows) occurring from unit processes within the system boundary.
 F = Emissions - Removals
 F = 0.02 + 0.06 + 0.01 + 0.001 + 0.003 - 0.02 = -0.08 kg C

Impact of Biogenic CO₂, Stock Accounting (S)

Considers change in stocks of carbon from unit processes within the system boundary.
 S = - (S1 + S2 + S4)
 S = - (0 + 0 + 0.02) = - 0.02 kg C

Figure 48. Cradle-to-Grave Biogenic Carbon Balance: 100%-Recycled Product

C. COMPARING 2006, 2010 AND 2014 ENVIRONMENTAL PERFORMANCES

The 2006 LCA of product was performed using a slightly different methodological framework than the 2010 and 2014 LCAs. Hence, they were not directly comparable. For this reason, the 2006 data were used to rebuild, to the extent possible, a model that matches the methodological framework used for the 2010 and 2014 models. More specifically, the original 2006 LCA model was modified as follows.

For the 2010 and 2014 studies, mill-level data were collected for chemical consumption, which resulted in an extensive list of chemicals. For 2006, the Fisher International Database was used to model chemical consumption and only two chemicals were modeled. Except for the two chemicals that were already modeled in 2006, the 2006 model was modified to include the same quantity of chemicals as in 2010 (based on the actual board mix). Note that in 2014 the chemical consumption data collection was streamlined to include only important chemicals.

For the original 2006 study, transportation distances were estimated by CPA. For the 2010, 2014 and updated 2006 studies, these were modeled after the U.S. Commodity Flow Survey (United States Department of Transportation and United States Department of Commerce 2010).

Data used for fuel combustion and electricity production were aligned.

Releases of toxic substances were added.

Because the utilization rate of recovered fiber was likely to have a significant effect on the results, it was decided to compare the yearly environmental performances based on the "2006, as collected", "2010, actual", "2014, actual" datasets. However, given that this implies doing a comparison based on slightly different methodologies, the "2006, as collected" dataset was also compared to the "2010, as collected" and "2014, as collected" dataset in a sensitivity analysis.

Table 48. Mix of Boards in U.S.-Average Containerboard (2006, 2010 and 2014)

Board type	2006		2010		2014	
	Collected	Actual	Collected*	Actual*	Collected	Actual
100%-recycled linerboard	10.8%	10.0%	10.3%	13.5%	9.6%	16.1%
All other linerboard	61.5%	57.3%	66.6%	55.3%	66.0%	50.7%
Total linerboard	72.3%	67.3%	76.9%	68.8%	75.6%	66.8%
100%-recycled corrugating medium	7.9%	12.3%	7.3%	13.1%	6.8%	14.4%
All other corrugating medium	19.8%	20.4%	15.9%	18.1%	17.7%	18.8%
Total corrugating medium	27.7%	32.7%	23.1%	31.2%	24.4%	33.2%

D. DETAILED DATA SOURCES

Table 49 lists the generic datasets used in the study.

Table 49. List of Datasets Used in the Study

<i>FIBER</i>			
Fiber name	Database	Specific dataset	Comment
Logs, Northern Hardwood	U.S. LCI	Pulpwood, hardwood, average, at forest road, NE-NC/RNA	
Logs, Southern Hardwood	U.S. LCI	Pulpwood, hardwood, average, at forest road, NE-NC/RNA	No data available for southern hardwood pulpwood, northern used as a proxy
Logs, Southern Softwood	U.S. LCI	Softwood logs with bark, harvested at average intensity site, at mill, US SE/US	Without transportation
Chips, Northern Hardwood	U.S. LCI	Wood chips, hardwood, green, at sawmill, NE-NC/kg/RNA	
Chips, Southern Hardwood	U.S. LCI	Wood chips, hardwood, green, at sawmill, NE-NC/kg/RNA	No data available for southern hardwood chips, northern used as a proxy
Chips, Northern Softwood	U.S. LCI	Wood chips, softwood, green, at sawmill NE-NC/kg/RNA	
Chips, Southern Softwood	U.S. LCI	Pulp chips, at sawmill, US SE/kg/US	
Recovered Paper, Mixed	N/A	Transportation only	
Recovered Paper, Corrugated	N/A	Transportation only	
Recovered Paper, Pulp Substitutes	N/A	Transportation only	
Recovered Paper, High-grade Deinking	N/A	Transportation only	
Purchased BKMP	NCASI	NCASI 2006/2007 bleached kraft market pulp dataset	
Purchased UBKMP	EI	Sulphate pulp, unbleached, at plant/RER	
Purchased RNDI	EI	Paper, recycling, no deinking, at plant/RER	No data for pulp, paper used as a proxy

(Table continued next page.)

Table 49. (Cont'd)

<u>CHEMICALS</u>			
Chemical name	Database	Specific dataset	Comment
Adhesive	GaBi	EU-27: Starch glue (for paper/cardboard)	
Aluminium chloride	EI	Chemicals inorganic, at plant/GLO	
Aluminum sulfate	GaBi	US: Aluminium sulphate (estimation)	
Borax	U.S. LCI	Sodium borates, at plant/US	
Coatings	EI	Coating powder, at plant/RER	
Dispersant	EI	Pitch despergents, in paper production, at plant/RER	
Ink	GaBi	US: Polyacrylate ink (estimation)	
Other fillers	Literature	Precipitated calcium carbonate used as a proxy for all other fillers	
Quicklime	U.S. LCI	Quicklime, at plant /US	
Soda	U.S. LCI	Soda, powder, at plant /US	Includes soda powder, soda ash and sodium carbonate
Sodium hydroxide	U.S. LCI	Sodium hydroxide, production mix, at plant/kg /RNA	
Starch	GaBi	US: Dried starch (corn wet mill) (economic allocation)	
Strength agents	GaBi	DE: Polyacrylamide (anionic) (solid)	Polyacrylamide is one type of strength agent, used as a proxy for all
Sulfuric acid	U.S. LCI	Sulfuric acid, at plant/RNA	
Wax	GaBi	EU-27: Wax/Paraffins at refinery	
<u>FUELS</u>			
Fuel name	Database	Specific dataset	Comment
Purchased Hogged Fuel, Logging Residues	U.S. LCI/US, NCASI	Forest residue, processed and loaded, at landing system/RNA, NCASI combustion emissions	

(Table continued next page.)

Table 49. (Cont'd)

<u>FUELS</u>			
Fuel name	Database	Specific dataset	Comment
Purchased Hogged Fuel, Manufacturing Residues	U.S. LCI/US, NCASI	Bark, at sawmill, US SE/kg US, NCASI combustion emissions	
Self-Generated Hogged Fuel, Logging Residues	U.S. LCI/US, NCASI	Forest residue, processed and loaded, at landing system/RNA, NCASI combustion emissions	
Self-Generated Hogged Fuel, Manufacturing Residues	NCASI	NCASI combustion emissions	
Spent Liquor Solids	NCASI	NCASI combustion emissions	
Self-Gen Hydroelectricity	EI	Electricity, hydropower, at run-of-river power plant/RER	
Non-Recyclable Paper	EI	Disposal, paper, 11.2% water, to municipal incineration/CH	
Other biomass	U.S. LCI/US, NCASI	Bark, at sawmill, US SE/kg/US, NCASI combustion emissions	
Sludge	NCASI	NCASI combustion emissions	
Coal	U.S. LCI	Bituminous coal, combusted in industrial boiler /US	
Distillate Fuel Oil (#2)	U.S. LCI	Diesel, combusted in industrial boiler/US	Diesel combustion used as a proxy for DFO combustion
Gasoline	U.S. LCI	Gasoline, combusted in equipment/US	
Kerosene	U.S. LCI	Diesel, combusted in industrial boiler/US	Diesel combustion used as a proxy for kerosene combustion
Liquid Propane Gas	U.S. LCI	Liquefied petroleum gas, combusted in industrial boiler/US	

(Table continued next page.)

Table 49. (Cont'd)

<u>CHEMICALS</u>			
<u>FUELS</u>			
Fuel name	Database	Specific dataset	Comment
Natural Gas	U.S. LCI	Natural gas, combusted in industrial boiler/m3/RNA	
Other Fuel/Other Fuel 1	U.S. LCI	Diesel, combusted in industrial boiler/US	Diesel combustion used as a proxy for other fuels
Petcoke	U.S. LCI/U.S. EPA	Bituminous coal, combusted in industrial boiler/US,	With coal replaced by petcoke and GHG emissions modeled after U.S. EPA (2010)
Residual Fuel Oil (#5,6)	U.S. LCI	Residual fuel oil, combusted in industrial boiler/US	
Rubber Tire Chips	Literature (U.S. EPA 1997)		
Purchased electricity	U.S. LCI/EI	See more details in Section 4.2.3.	
Purchased steam	U.S. LCI	See more details in Section 4.2.3.	Steam mix obtained from the mills purchasing steam (mostly coal)
<u>WASTE MANAGEMENT</u>			
Name	Database	Specific dataset	Comment
Residuals, landfilled	NCASI	N/A	
Residuals, land applied	EI	N/A	
Residuals, burned	NCASI	N/A	Assumed to be included in combustion emissions
Sludge, ash, other waste, other beneficial	N/A	N/A	Ignored
Effluent to river	NCASI	N/A	
Effluent to municipal treatment	GaBi	EU-27: Waste water treatment (slightly organic and inorganic contaminated) PE	

(Table continued next page.)

Table 49. (Cont'd)

<u>TRANSPORT</u>			
Name	Database	Specific dataset	Comment
Truck	U.S. LCI	Transport, combination truck, diesel powered/US	
Train	U.S. LCI	Transport, train, diesel powered/US	
Boat, river	U.S. LCI	Transport, barge, average fuel mix/US	
Boat ocean	U.S. LCI	Transport, ocean freighter, average fuel mix/US	
Pipeline	EI	Transport, natural gas, pipeline, long distance/RER Transport, crude oil pipeline, onshore/RER	
<u>END-OF-LIFE</u>			
Name	Database	Specific dataset	Comment
Landfill of corrugated packaging	GaBi	US: Waste on landfill	Carbon modeled using methods described in Section 4.2.7.2
Incineration of corrugated packaging	GaBi	EU-27: Incineration of paper waste PE	Carbon modeled based on U.S. conditions

E. DETAILED INVENTORY DATA - AVERAGE CONTAINERBOARD

Table 50 presents the details of the containerboard data as collected.

Table 50. Detailed Containerboard LCI Data (per 1 odst of Containerboard)

Name	Unit*	Quantity	Average water content
<u>WATER INPUTS</u>			
Water (process and cooling)	m ³	25.4	50.0%
<u>FIBER INPUTS</u>			
Logs, Northern Hardwood	odst	2.16E-02	50.0%
Logs, Southern Hardwood	odst	1.08E-01	50.0%
Logs, Southern Softwood	odst	5.26E-01	50.0%
Chips, Northern Hardwood	odst	5.07E-02	50.0%
Chips, Southern Hardwood	odst	4.31E-02	50.0%
Chips, Northern Softwood	odst	68.87E-02	50.0%
Chips, Southern Softwood	odst	2.01E-01	50.0%
Recovered Paper, Mixed	odst	1.02E-02	10.0%
Recovered Paper, Corrugated	odst	5.04E-01	10.0%
Recovered Paper, Pulp Substitutes	odst	5.86E-03	10.0%
Purchased BKMP	odst	6.57E-04	10.0%
Purchased UBKMP	odst	1.15E-04	10.0%
Purchased RNDI	odst	3.76E-03	10.0%
<u>CHEMICALS/ADDITIVES</u>			
Aluminium sulfate	kg	2.20	Total weight of water in chemicals: 14.9 kg
Caustic	kg	6.30	
Starch	kg	4.45	
Sulfuric acid	kg	9.60	
Strength agents	kg	0.58	
Lime	kg	7.40	
Soda powder	kg	2.99	
Dispersants	kg	0.05	
Other fillers	kg	4.54	
<u>FUELS/ENERGY</u>			
Purchased Hogged Fuel, Logging Residues	tons	9.64E-03	N/A
Purchased Hogged Fuel, Manufacturing Residues	tons	1.09E-1	N/A
Self-Generated Hogged Fuel, Logging Residues	tons	3.26E-3	N/A
Self-Generated Hogged Fuel, Manufacturing Residues	tons	1.11E-1	N/A
Spent Liquor Solids	tons	5.24E-01	N/A

(Table continued next page. See notes at end of table.)

Table 50. (Cont'd)

Name	Unit*	Quantity	Average water content
<u>FUELS/ENERGY</u>			
Self-Gen Hydroelectricity	MMBtu	2.76E-03	N/A
Non-Recyclable Paper	tons	3.69E-3	N/A
Other biomass	tons	6.43E-03	N/A
Sludge	tons	6.24E-03	N/A
Coal	tons	3.53E-02	N/A
Distillate Fuel Oil (#2)	gal	1.33E-01	N/A
Gasoline	gal	2.50E-03	N/A
Kerosene	gal	7.42E-03	N/A
Liquid Propane Gas	gal	2.40E-02	N/A
Natural Gas	1000 ft ³	3.16E+00	N/A
Other Fuel	MMBtu HHV	1.60E-02	N/A
Residual Fuel Oil (#5,6)	gal	5.74E-01	N/A
Rubber Tire Chips	tons	3.54E-03	N/A
Purchased electricity	Million kWh	3.80E-04	N/A
Purchased steam	MMBtu	6.04E-01	N/A
<u>PRODUCTS/COPRODUCTS</u>			
Average containerboard	odst	1.00E00	8.2%
Turpentine and tall oil	kg	13.8	N/A
Sold electricity	Million kWh	1.63E-05	N/A
<u>EMISSIONS TO AIR</u>			
Nitrogen oxides	kg	1.28	N/A
Sulfur oxides	kg	0.95	N/A
Total reduced sulfur	kg	0.064	N/A
Particulates	kg	0.50	N/A
Carbon monoxide	kg	0.21	N/A
Carbon dioxide, biogenic	kg	1023	N/A
Carbon dioxide, fossil	kg	272	N/A
Methane, biogenic	kg	2.94	N/A
Methane, fossil	kg	0.012	N/A
Nitrous oxide	kg	0.041	N/A
Water evaporation	m ³	2.72	N/A
<u>EMISSIONS TO WATER</u>			
Process effluent	m ³	22.2	N/A
Cooling water discharges	m ³	1.51	N/A

(Table continued next page. See notes at end of table.)

Table 50. (Cont'd)

Name	Unit*	Quantity	Average water content
<u>EMISSIONS TO WATER</u>			
Absorbable organic halides	kg	3.5E-3	N/A
Biological oxygen demand	kg	0.80	N/A
Total suspended solids	kg	1.10	N/A
Total nitrogen	kg	0.17	N/A
Total phosphorus	kg	0.018	N/A
<u>RESIDUALS</u>			
Wastewater treatment plant residuals	kg	31.1	N/Av.
Wood ashes	kg	19.4	N/Av.
Coal ashes	kg	5.25	N/Av.
Other solid wastes	kg	40.0	N/Av.

*All tons are short tons.

F. MODIFIED MASS ALLOCATION

Mill-specific environmental release and energy consumption data for forest products manufacturing in the U.S. were available from surveys done by the national industry organizations in the U.S. These data are aggregated at the whole mill level (e.g., total pounds of BOD₅ released in treated effluent from a mill in a year). Life cycle studies are often focused on particular consumer products. Because most mills make a variety of paper products, and sometimes from a variety of furnishes, use of mill-level environmental data in such studies calls for *allocation* of the mill environmental and energy burdens to the product(s) of interest made at the mills. ISO 14044 (ISO 2006b, 4.4.4.2, p. 14) addresses this issue:

"Wherever possible, allocation should be avoided by [...] dividing the unit process to be allocated into two or more sub-processes and collecting the input and output data related to these sub-processes."

This was applied as much as possible by collecting additional data (supplemental survey). However, this was not sufficient to fully solve the allocation problem. In this case, ISO 14044 (ISO 2006b, 4.4.4.2, p. 14) specifies the following:

"Where allocation cannot be avoided, the inputs and outputs of the system should be partitioned between its different products or functions in a way that reflects the underlying physical relationships between them; i.e., they should reflect the way in which the inputs and outputs are changed by quantitative changes in the products or functions delivered by the system."

To achieve this, the method outlined in Section 3.5.2.1 was applied, but again was not sufficient to completely solve the internal allocation problem.

One way to allocate environmental loads or energy consumption (hereafter referred to as "burdens") might be by mass of product made. That is, if the product of interest accounts for half of the mass of all products made at the mill, then half of the total mill burden would be allocated to that product. This method overlooks differences in burdens that might be contributed by different furnishes, however. For example, consider a mill that produces equal quantities of linerboard from 100% unbleached kraft pulp and corrugating medium from 100% OCC (recycled fiber). If the mill reported release of 100 tons of TRS, simple mass allocation would assign 50 tons of TRS to the kraft linerboard and 50 tons to the medium. However, process knowledge indicates that essentially all the TRS should be allocated to the linerboard because TRS releases from the kraft process, if present, will dwarf any releases from the OCC recycling process. Similarly, NCASI has process knowledge for other environmental parameters and energy consumption that has been developed through benchmarking studies of the data referenced above. In those studies, mills are categorized with more emphasis on their production processes than on their product types.

This appendix describes the modified mass allocation methodology that was used in this study. This methodology incorporates process knowledge to yield allocated environmental and energy burdens that better reflect the true burdens attributable to each product made at a mill.

F.1 kraft Pulping Parameters

Some parameters are specific to kraft pulping: spent liquor, some air releases, self-generated bark. These were allocated based on kraft pulp produced.

F.2 Other Parameters

The proposed modified mass allocation methodology is summarized in this section using a hypothetical example mill for which the production information is provided in Table 51, with five separate production lines, which, according to industry survey data, made 787,100 short tons of finished products and released 1,442,464 pounds of BOD₅ in treated effluent.

Table 51. Example Mill Producing Multiple Products from Multiple Furnishes

Grade	Finished product	% of all products*
Corrugating medium	Recycled corrugating medium	17.8
kraft paper	Bag and sack	4.4
kraft paper	Bag and sack	11.1
kraft paper	Wrapping paper	11.1
Linerboard	kraft linerboard	55.6

*Rounded to 1 decimal place. All available digits used in actual calculations.

Table 52 shows the results of simple mass allocation of the BOD₅ burden for each finished product at the mill (by production line).

Table 52. Example Mill Simple Mass Allocation of BOD₅

Grade	Finished product	% of all products	BOD ₅ simple mass allocation, lb*
Corrugating medium	Recycled corrugating medium	17.8	256,759
kraft paper	Bag and sack	4.4	63,468
kraft paper	Bag and sack	11.1	160,114
kraft paper	Wrapping paper	11.1	160,114
Linerboard	kraft linerboard	55.6	802,010

*Rounded to the nearest integer.

The total burden allocated to bag and sack production at this mill, using simple mass allocation, would be 223,582 lb., the total of the two bag and sack production lines.

Incorporation of process knowledge into the allocation calculation requires knowledge about (1) the production processes used at the mill and (2) the burdens associated with those processes. Table 53 shows the furnish types, which are closely related to production processes, for each product, as derived from Fisher International information, for the example mill.

Table 53. Example Mill Products and Furnishes

Finished product	% of all products	Furnish* as percent of total furnish for finished product		
		RNDI	SC	UBK
Recycled corrugating medium	17.8	40	60	0
Bag and sack	4.4	8	0	92
Bag and sack	11.1	0	0	100
Wrapping paper	11.1	0	0	100
kraft linerboard	55.6	6	0	94

* More details provided in Table 54.

Table 54 lists NCASI benchmarking production categories, their descriptions, and the benchmarking production-weighted mean (PWM) loading rate for final effluent BOD₅ associated with each mapped production category. The mill count indicates the number of mills from which NCASI has information. These values can be updated each year. The latter information represents NCASI process knowledge that is incorporated into the allocations using the methodology presented here.

Table 54. NCASI Production Categories

NCASI production category	Category description	2006 final effluent BOD PWM	
		lb/ton*	Mill count
Bleached chemi-thermomechanical (BCTMP)	Mills that produce bleached chemi-thermomechanical market pulps.	**	**
Bleached kraft, integrated (BKI)	Mills that produce paper, market pulp, or bleached board whose total fiber is comprised of at least 75% bleached kraft pulp produced on-site, where market pulp represents less than 67% of total product.		
Bleached kraft, other (BKO)	Mills that produce bleached kraft or soda pulp comprising at least 18% but less than 75% of the fiber contained in final products. These mills make an assortment of final products that may incorporate mechanical pulps, secondary fiber, or purchased fiber.		
Bleached kraft (BK)	Combination of BKI and BKO	3	46
Bleached kraft market pulp (BKMP)	Mills that produce paper, market pulp, or bleached board whose total fiber is comprised of at least 75% bleached kraft pulp produced on-site, where market pulp represents at least 67% of total product.		
Bleached kraft dissolving (BKD)	Mills that produce dissolving grade bleached kraft pulps.		
Unbleached kraft 1 (UK1)	Mills whose final products are comprised of at least 85% unbleached kraft or semi-chemical pulps produced on-site. No pulp bleaching is done on-site.		

(Table continued next page. See notes at end of table.)

Table 54. (Cont'd)

NCASI production category	Category description	2006 final effluent BOD PWM	
		lb/ton*	Mill count
Unbleached kraft 2 (UK2)	Mills whose final products are comprised of less than 85% unbleached kraft or semi-chemical pulps produced on-site. The balance of the fiber furnish may include non-deinked secondary fiber, mechanical pulps. No pulp bleaching is done on-site.		
Unbleached kraft (UK)	UK1 and UK2 combined but excluding mills producing any bleached chemical pulp.	2	30
Semi-chemical (SC)	Mills producing corrugating medium from semi-chemical pulps produced on-site and non-deinked secondary fiber. They may also produce linerboard from recycled fiber.	0.7	10
Mechanical (MECH)	Mills whose final products are comprised primarily of mechanical pulps manufactured on-site. No chemical pulps are produced on-site.	1	9
Deinked tissue/fine papers (DTF)	Mills that produce tissue/toweling or fine papers from deinked secondary fiber produced on-site.		
Deinked newsprint (DNWS)	Mills that produce newsprint from deinked secondary fiber produced on-site.		
Recycled deinked newsprint and fine paper (RDI)	Combination of DTF and DNWS	2	8
Recycled tissue/fine papers (RTF)	Mills that produce tissue/toweling or fine papers from non-deinked secondary fiber produced on-site.		
Recycled containerboard (RCTR)	Mills that produce linerboard and corrugating medium, typically on fourdrinier machines, from non-deinked secondary fiber produced on-site.		
Recycled boxboard (RBOX)	Mills that produce boxboard, tube stock, and similar products, typically on cylinder machines, from non-deinked secondary fiber produced on-site.		
Recycled non-deinked (RNDI)	Combination of RTF, RCTR and RBOX	1	50
Non-integrated fine or lightweight papers (NIF)	Mills that produce fine or lightweight papers from purchased fiber.	0.7	5
Non-integrated other papers (NIO)	Mills that produce tissue, filter, or other papers from purchased fiber.		
Sulfite paper grade (SULP)	Mills that produce paper primarily from sulfite pulp produced on-site.	9	2
Sulfite dissolving pulp (SULD)	Mills that produce dissolving grade sulfite pulps.		

*Values rounded to one significant figure for illustration purposes. All available digits used in actual calculations.

**There is no U.S. BCTMP production. North American PWM is 2 lb/st.

The knowledge about the production processes used at the example mill and the PWM loading rates associated with those processes are combined with the simple mass allocation calculation in **Equation 1** to calculate the burden that would be associated with each product if the furnish production processes are contributing to the burden at their industry PWM rates:

$$B_i = P_{tot} P_i \sum_{j=1}^f F_{ij} M_{ij} \quad \text{Equation 1}$$

B_i: the expected burden associated with the ith product if all furnish processes are contributing at their industry PWM rates

P_{tot}: the total production for all products at the mill

P_i: the fraction of total production represented by the ith product

F_{ij}: the fraction of the total furnish for the ith product represented by the jth furnish

M_{ij}: the industry PWM loading rate for the jth furnish of the ith product

f: the number of furnishes for the ith product.

For example, the expected annual load of BOD₅ associated with recycled corrugating medium at the example mill is:

$$B_{RecyCM} = 787,100 \text{ tons} (0.178) [0.40 (1 \text{ lb} / \text{ton}) + 0.60 (0.7 \text{ lb} / \text{ton})] = 114,885 \text{ lb}$$

The fractional allocation of the whole mill burden to the ith product is computed using **Equation 2**:

$$A_i = \frac{B_i}{\sum_{i=1}^p B_i} \quad \text{Equation 2}$$

A_i: the fractional allocation of whole mill burden to the ith product

p: the number of products made at the mill

Table 55 presents the results from Equations 1 and 2 for the example mill.

Table 55. Example Mill BOD₅ Allocations Incorporating Process Knowledge

Finished product	P _i , %	P _{tot} P _i F _{ij} M _{ij} , lb			Equation 1	Equation 2
		NDI	SC	UK	B _i *, lb	A _i , %
Recycled corrugating medium	17.8	56,042	58,844	0	114,885	8.3
Bag and sack	4.4	2,771	0	63,724	66,494	4.8
Bag and sack	11.1	0	0	174,736	174,736	12.7
Wrapping paper	11.1	0	0	174,736	174,736	12.7
kraft linerboard	55.6	26,258	0	822,740	848,998	61.5
Totals*	100	153	38.3	165	1,379,849**	100

*Totals shown may differ from the sum of components due to rounding. In the actual calculations, only the final result is rounded. **The expected average total load for a mill like the example mill is about 1.38 million lb BOD₅, which is slightly less than the 1.44 million lbs. the mill reported releasing. This indicates that release rates for one or more production processes at the mill are slightly greater than the industry production weighted mean loading rates for those processes. See the Limitations section for a discussion of the implications of this kind of discrepancy.

For ease of implementation in spreadsheets and database queries, the calculations can be simplified by substituting Equation 1 for B_i in Equation 2:

$$A_i = \frac{P_{tot} P_i \sum_{j=1}^f F_{ij} M_{ij}}{P_{tot} \sum_{i=1}^p \left(P_i \sum_{j=1}^f F_{ij} M_{ij} \right)} \quad \text{Equation 3}$$

Equation 3 can then be reduced to **Equation 4**:

$$A_i = \frac{P_i \sum_{j=1}^f F_{ij} M_{ij}}{\sum_{i=1}^p \left(P_i \sum_{j=1}^f F_{ij} M_{ij} \right)} \quad \text{Equation 4}$$

If Equation 4 is used for the calculation it is not necessary to know the total production at the mill. While Equation 2 is, perhaps, easier to grasp conceptually, Equation 4 may be easier to implement in a spreadsheet or in database queries.

With values for A_i for each product, actual burdens allocated to each product can be calculated by multiplication of A_i and the total reported burden for the mill. Results for the example mill are shown in Table 56.

Table 56. Example Mill Mass Allocation of BOD₅ with and without Incorporation of Process Knowledge

Finished product	Simple allocation based on product mass		Allocation incorporating process knowledge		
	% of all products	BOD ₅ , lb	A _i , %	BOD ₅ , lb	Difference from simple allocation, lb
Recycled corrugating medium	17.8	256,759	8.3	120,098	-136,661
Bag and sack	4.4	63,468	4.8	69,512	6,044
Bag and sack	11.1	160,114	12.7	182,665	22,551
Wrapping paper	11.1	160,114	12.7	182,665	22,551
kraft linerboard	55.6	802,010	61.5	887,523	85,513
Totals*	100	1,442,464	100	1,442,464	0

*Totals shown may differ from the sum of components due to rounding. In the actual calculations, only the final result is rounded.

Compared to simple product mass allocation, the allocations calculated from Equation 2 (or 4) shift over half of the load from the recycled corrugating medium, which contains no kraft pulp produced on-site, to the other products, which are made primarily from kraft pulp. The shift occurs because the PWM loading rate for kraft furnish (3 lb/t) is higher than the PWMs for the recycled (1 lb/t) and semichemical (0.7 lb/t) furnishes for the corrugating medium.

For burdens that are dependent on the fuel type and/or combustion conditions for heat and power generation at a mill (e.g., greenhouse gases, power boiler sulfur dioxide, and nitrogen oxides), the fractional allocated burdens are the same as the fractional allocation for energy consumption associated with generation of those burdens. For example, only the fossil energy allocation would be used to allocate greenhouse gas releases. For allocation of energy consumption, the calculations are done exactly as illustrated here using production-weighted mean energy consumption rates that are related to the furnish production processes. Individual fuel allocations are done using allocations for the appropriate kind of energy. For example, fossil fuel consumption is allocated using the allocation fraction computed for fossil energy consumption. Biofuel consumption is allocated using the bioenergy allocation fraction. Purchased electricity is allocated separately since this energy source is also related to production type, particularly for mechanical pulping.

The proposed methodology is based on knowledge of the production-weighted mean environmental loading and energy consumption rates associated with particular production processes (i.e., furnishes). For any parameter for which a relationship with particular production processes can be credibly established, the methodology should yield reasonably accurate allocations.

To the extent that the relationship between loadings and furnish processes at a particular mill differ from the PWMs, the allocations will be inaccurate. As noted above, it is apparent that BOD₅ release rates for one or more production processes at the example mill are slightly greater than the industry PWMs for those processes. If all processes at the mill are similarly elevated, perhaps because the wastewater treatment plant is unusually inefficient, then the allocations

should be reasonably accurate. If, however, only some processes are elevated, perhaps because of unusually poor black liquor spill control causing just the UK releases to be elevated, error would be introduced into the allocations for an individual mill. Of course, if the latter situation could be accurately identified at all mills, there would be little need for allocation methodologies like those proposed here. The effect of this kind of inaccuracy should diminish as allocated loads from a number of mills are combined to produce production-weighted mean allocated burdens for further use in a life cycle study.

G. NUMBER OF USES METHOD

G.1 Introduction

The ISO 14044 Standard (ISO 2006b) recommends, where allocation for open-loop recycling cannot be avoided through system expansion or by using a closed-loop approximation, that “the allocation procedures for the shared unit processes ... should use, as the basis for allocation, if feasible, the following order:

- Physical properties (e.g., mass);
- Economic value (e.g., market value of the scrap material or recycled material in relation to market value of primary material); or
- The number of subsequent uses of the recycled material (see ISO/TR 14049).”

The Number of Uses (NOU) method, as described in the ISO/TR 14049 Technical Report (ISO 2012b), was used as an alternative approach when comparing the 100%-recycled and industry-average products. This allocation procedure is based on physical properties and number of subsequent uses of the recovered material. The steps, as described by the ISO/TR 14049 Technical Report, are presented in Figure 49.

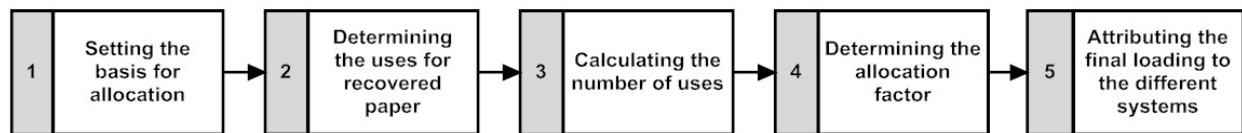

Figure 49. Stepwise Procedure for Applying the Number-of-Uses Allocation Procedure to Pulp and Paper Products

G.2 Application of the NOU Method to Corrugated Product

This section discusses the determination of which proportion of the environmental burden associated with the production of industry-average corrugated product from virgin fiber stays within the studied system and which portion is transferred to subsequent uses.

G.2.1 Recovery of OCC

Setting the Basis for Allocation

The “basis” upon which the allocation factor is made – that is, the total loading that will be allocated between the primary product and the products derived from recycled fibers – reflects the loadings associated with the primary product system, through the end of product life.

Determining the Uses for Recovered Paper

According to AF&PA, the average recovery rate of OCC in 2014 was 89.5%. The NOU method was applied only to the fraction considered to be in closed-loop²⁴ applicable only to open-loop

²⁴ The true application of the NOU method would be to apply a credit for everything that is recycled and import burden to all use of recovered fiber, which is the same as applying it to the closed-loop fraction only.

recycling which represents 47.0% (the other 42.5% being recycled in closed-loop). As illustrated in Figure 50, OCC is recovered, when not used for containerboard production, into tissue paper, packaging paper, paperboard (including construction paper and board), P&W paper products, and newsprint (exports are not considered in this figure) (AF&PA 2009)²⁵. Parameters for calculating the number of uses are presented in Table 57. To simplify the calculation procedure, the closed-loop assumption was made for the second and higher passes of recycling (i.e., $z_3 = x_3$), as proposed in ISO 14049.

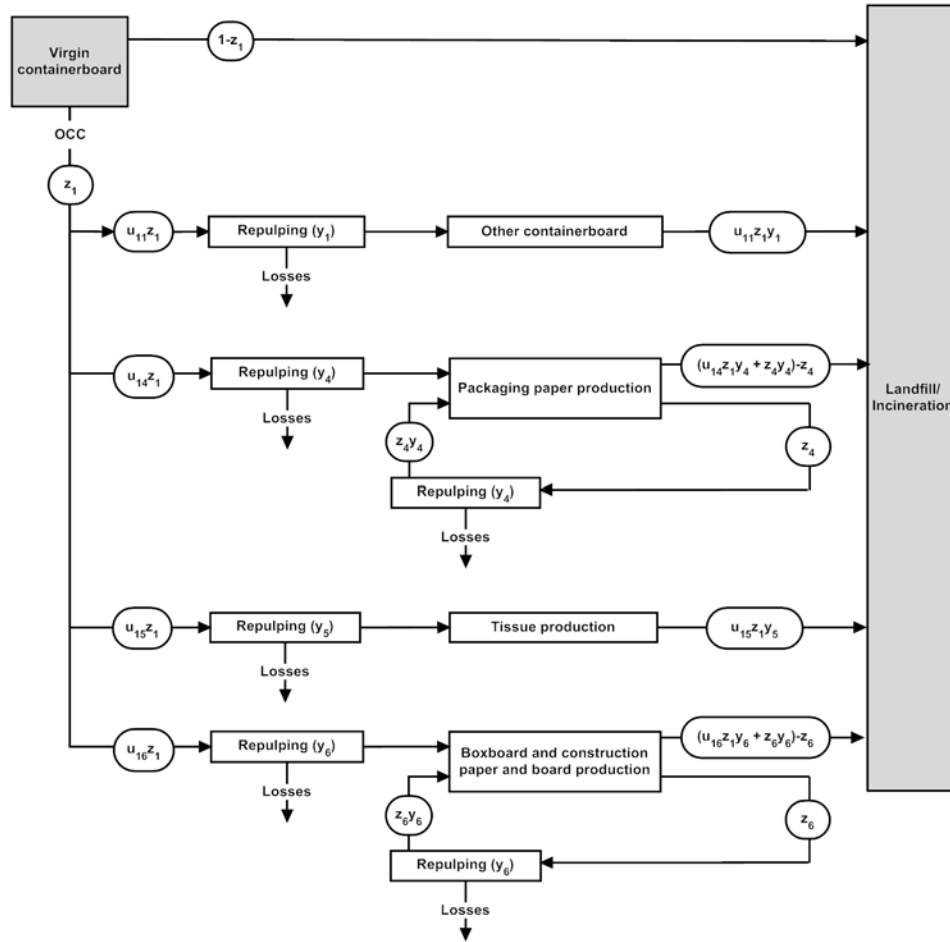

Figure 50. Uses of Recovered OCC: Open-Loop Recycling

²⁵ NCASI NOU model is based on 2008 industry data. The model was not updated to 2010 but this is not expected to have significant effect on the number of uses calculated.

Table 57. Data for Calculating the Number of Uses of OCC

z_1	0.47 [§]				
$u_{11}^{*,§}$	0	y_1^\dagger	0.95	z_1^\ddagger	0.892
u_{14}^*	0.136	y_4^\dagger	0.90	z_4^\ddagger	0.277
u_{15}^*	0.057	y_5	0.65		
u_{16}^*	0.807	y_6^\dagger	0.90	z_6^\ddagger	0.770

* u_{ij} from AF&PA (2015) $^\dagger y_i$ from Clark et al. (1987). $^\ddagger z_i$ from U.S. EPA (2015), for each grade the most recent available data was used. [§]When applying the number of use to the industry average, only the fraction in open-loop recycling was considered. In consequence, OCC recovered in containerboard was not considered.

Calculating the Number of Uses

In the system illustrated in Figure 50, the number of uses can be calculated as follows:

$$u \approx 1 + z_1[u_{14}y_4/(1-z_4y_4) + u_{15}y_5 + u_{16}y_6/(1-z_6y_6)] \approx 2.22$$

Determining the Allocation Factor and Attributing the Final Loading to the Different Systems

The allocation factor for virgin production can be calculated as follows:

$$A_v = (1 - z_1) + (z_1/u) = 0.74$$

This means that 74% of the environmental burden from using virgin fiber for production of containerboard stays within the system and 26% is exported to subsequent uses.

The environmental impacts were calculated as an industry average that consists of a mix of virgin and recycled pulp production. At this level, the data did not allow determination of which fraction of the environmental impacts arising at pulp and paper mills is attributable to the virgin production, and thus to apply the calculated allocation factor directly. The following procedure was used as an approximation.

- In cases where it is obvious that an environmental burden is attributable to virgin production (e.g., direct consumption of wood fiber, purchased virgin pulp, etc.), the allocation factor A_v was applied directly.
- For other cases, the fraction of product manufactured from virgin fiber (f_v) was determined based on the inputs of recovered paper, wood and purchased pulp, and using typical yields.
- The calculated fraction was used to calculate a corrected allocation factor, which was further adjusted with a variable factor F in the case of effluent, water use and energy to account for typical differences in virgin and recycled production ($A_v' = A_v f_v F$).
- The corrected allocation factor (A_v') was applied to environmental impacts.

G.2.2 Use of Recovered Paper to Produce Industry-Average and 100%-Recycled

It was also necessary to calculate the virgin production burden that comes with consumption of recovered paper for production of containerboard (industry-average and 100%-recycled). Mixed papers and pulp substitutes (PS) were recovered into containerboard. An allocation factor needed

to be calculated for these three. A similar approach to the one described above, but where the fraction of virgin load attached with a given amount of recovered fiber is calculated instead, was applied. More details regarding the applied approach can be found elsewhere (NCASI 2012). The calculated allocation factors were as follows:

- mixed papers: 0.18 kg of virgin production/kg of recovered mixed paper;
- pulp substitute: 0.25 kg of virgin production/kg of recovered PS.

In the case of the 100%-recycled product, no virgin production burden is exported but a virgin production burden is imported for each ton of recovered fiber used, including OCC. That allocation factor was estimated with the method described above: 0.15 kg of virgin production burden/kg of additional OCC.

The virgin production burden associated with each of the recovered fiber grade were approximated as follows:

- mixed papers: bleached kraft market pulp modeled using AF&PA data (NCASI 2010);
- pulp substitute: all other linerboard as modeled in this study; and
- OCC: all other linerboard as modeled in this study.

H. IMPACT INDICATORS

H.1 Global Warming (GW)

The mechanism of the greenhouse effect can be observed on a small scale, as the name suggests, in a greenhouse. These effects are also occurring on a global scale. The short-wave radiation from the sun comes into contact with the earth's surface and is partly absorbed (leading to direct warming) and partly reflected as infrared radiation. The reflected part is absorbed by so-called greenhouse gases in the troposphere and is re-radiated in all directions, including back to Earth. This results in a warming effect at the earth's surface. In addition to the natural mechanism, the greenhouse effect is enhanced by human activities. Greenhouse gases that are considered to be caused, or increased, anthropogenically are, for example, carbon dioxide, methane and CFCs. Figure 51 shows the main processes of the anthropogenic greenhouse effect. An analysis of the greenhouse effect should consider the possible long-term global effects. The global warming potential is calculated in carbon dioxide equivalents (CO₂ eq.). This means that the greenhouse potential of an emission is given in relation to CO₂. Since the residence time of the gases in the atmosphere is incorporated into the calculation, a time range for the assessment must also be specified. A period of 100 years is customary.

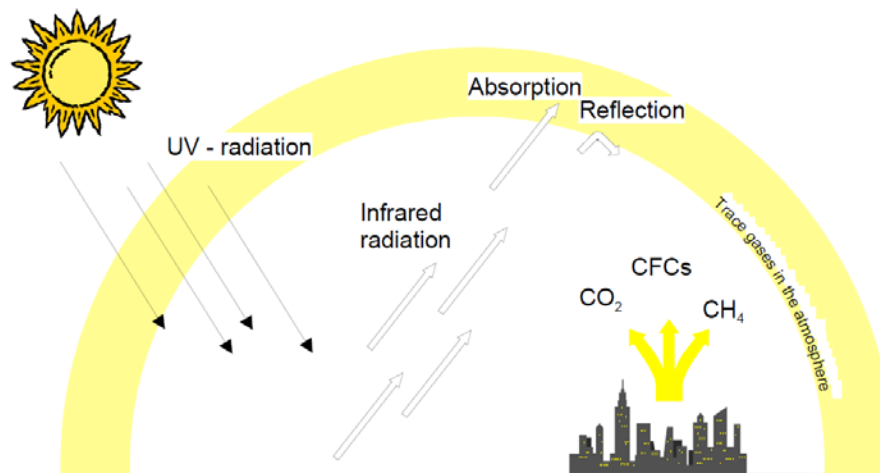

Figure 51. Greenhouse Effect

H.2 Ozone Depletion (ODP)

Text taken from Bare et al. (2003, p. 56)

Ozone depletion is the reduction of the protective ozone within the stratosphere caused by emissions of ozone-depleting substances. Recent anthropogenic emissions of chlorofluorocarbons (CFCs), halons, and other ozone-depleting substances are believed to be causing an acceleration of destructive chemical reactions, resulting in lower ozone levels and ozone "holes" in certain locations. These reductions in the level of ozone in the stratosphere lead to increasing ultraviolet-B (UVB) radiation reaching the earth. As shown in Figure 52, increasing UVB radiation can cause additional cases of skin cancer and cataracts. UVB radiation can also

have deleterious effects on crops, materials, and marine life. International consensus exists on the use of ozone depletion potentials, a metric proposed by the World Meteorological Organization for calculating the relative importance of CFCs, hydrochlorofluorocarbons (HFCs), and halons expected to contribute significantly to the breakdown of the ozone layer. The reference substance is CFC-11 (CFC-11 eq.).

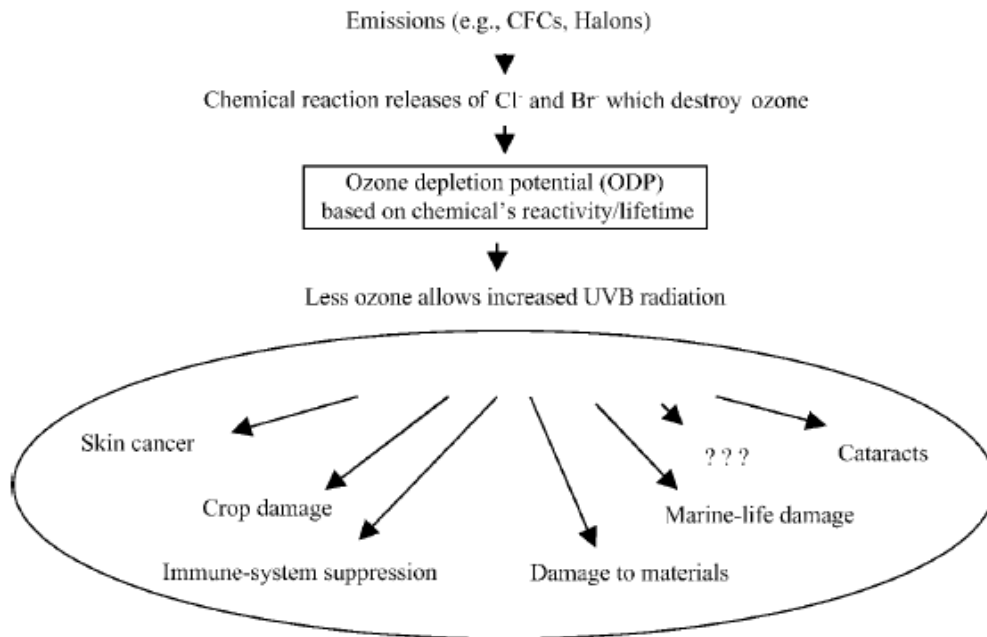

Figure 52. Ozone Depletion Impact Pathways
[Figure taken from Bare et al. (2003, p. 54)]

H.3 Acidification (AP)

The acidification of soils and waters occurs predominantly through transformation of air pollutants into acids. This leads to a decrease in the pH value of rainwater and fog from 5.6 to 4 and below. Sulfur dioxide, nitrogen oxide and their respective acids (H₂SO₄ and HNO₃) produce relevant contributions. This damages ecosystems, whereby forest dieback is the most well-known impact. Acidification has direct and indirect damaging effects (such as nutrients being washed out of soils or an increased solubility of metals into soils). But even buildings and building materials can be damaged. Examples include metals and natural stones that are corroded or disintegrated at an increased rate. When analyzing acidification, it should be considered that although it is a global problem, the regional effects of acidification could vary. Figure 53 displays the primary impact pathways of acidification. The acidification potential is given in sulfur dioxide equivalents (SO₂ eq.). The acidification potential is described as the ability of certain substances to build and release H⁺ - ions. Certain emissions can also be considered to have an acidification potential, if the given S-, N- and halogen atoms are set in proportion to the molecular mass of the emission. The reference substance is sulfur dioxide.

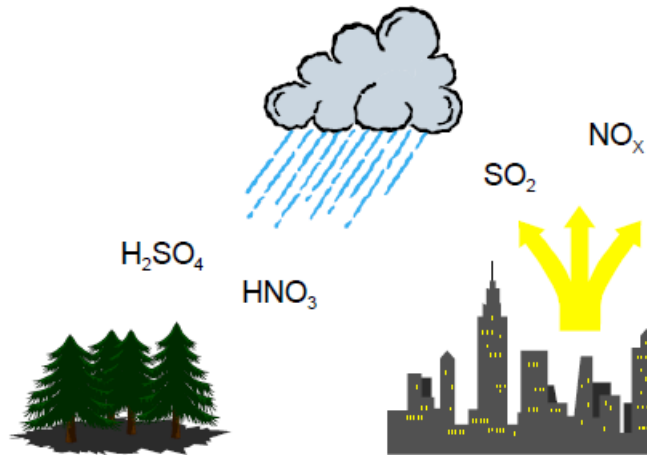

Figure 53. Acidification Impact Pathways

H.4 Eutrophication (EP)

Eutrophication is the enrichment of nutrients in a certain place. Eutrophication can be aquatic or terrestrial. Air pollutants, wastewater and fertilization in agriculture all contribute to eutrophication. The result in water is accelerated algae growth, which in turn prevents sunlight from reaching the lower depths. This leads to a decrease in photosynthesis and less oxygen production. In addition, oxygen is needed for decomposition of dead algae. Both effects cause a decreased oxygen concentration in the water, which can eventually lead to fish dying and to anaerobic decomposition (decomposition without the presence of oxygen). Hydrogen sulfide and methane are thereby produced. On eutrophicated soils, increased susceptibility of plants to diseases and pests is often observed, as is degradation of plant stability. If the eutrophication level exceeds the amounts of nitrogen necessary for a maximum harvest, it can lead to an enrichment of nitrate. This can cause, by means of leaching, increased nitrate content in groundwater. Nitrate also can end up in drinking water. Nitrate at low levels is harmless from a toxicological point of view. However, nitrite, a reaction product of nitrate, can be toxic to humans at excessive doses. The causes of eutrophication are displayed in Figure 54.

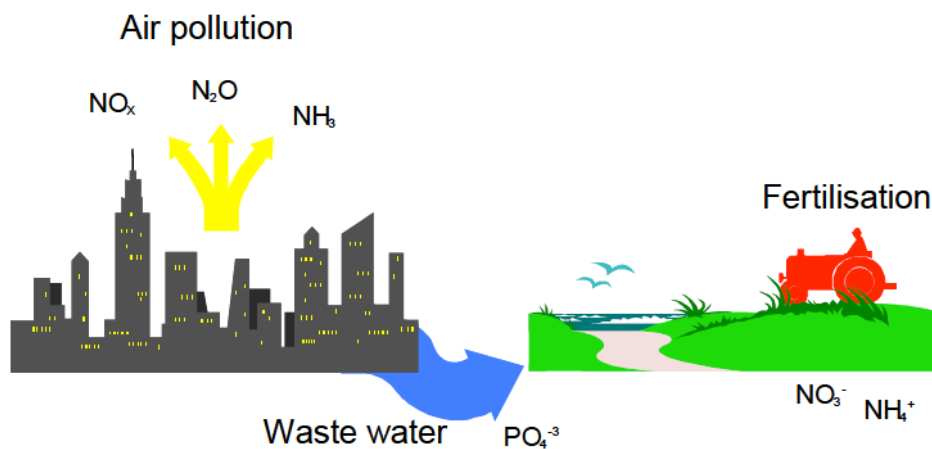

Figure 54. Eutrophication Impact Pathways

The eutrophication potential is calculated in nitrate equivalents (N eq.). As with acidification potential, it's important to remember that the effects of eutrophication potential differ regionally and can vary significantly in different water bodies.

H.5 Photo-Chemical Oxidant Formation (Smog, POCP)

Despite playing a protective role in the stratosphere, at ground-level ozone is classified as a damaging trace gas. Photo-chemical ozone production in the troposphere, also known as summer smog, is suspected to damage vegetation and material. High concentrations of ozone are toxic to humans. Radiation from the sun in the presence of nitrogen oxides and hydrocarbons can result in complex chemical reactions, producing aggressive reaction products, one of which is ozone. Nitrogen oxides alone do not cause high ozone concentration levels. Hydrocarbon emissions occur from incomplete combustion, in conjunction with petrol (storage, turnover, refueling etc.) or from solvents. High concentrations of ozone arise when the temperature is high, humidity is low, when air is relatively static and when there are high concentrations of hydrocarbons. Because CO (mostly emitted from vehicles) reduces the accumulated ozone to CO₂ and O₂, high concentrations of ozone do not often occur near hydrocarbon emission sources. Higher ozone concentrations more commonly arise in areas of clean air, such as forests, where there is less CO (Figure 34). In TRACI, photo-chemical ozone formation is referred to in ozone equivalents (O₃ eq.). When analyzing, it's important to remember that the actual ozone concentration is strongly influenced by the weather and by the characteristics of the local conditions.

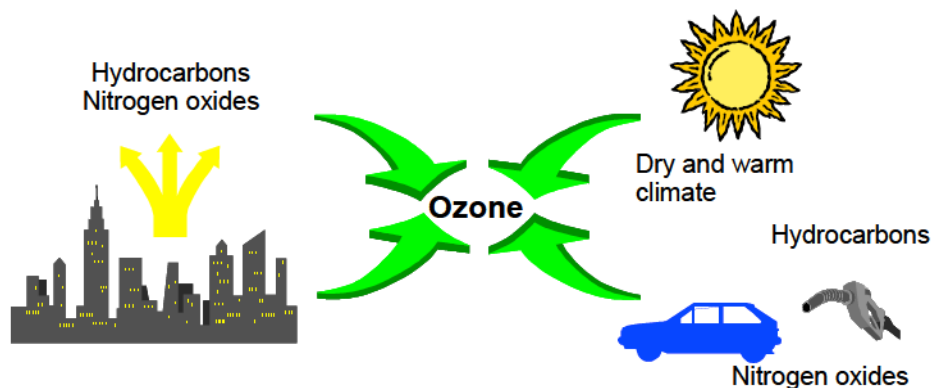

Figure 55. Photo-Chemical Oxidant Formation Impact Pathways

H.6 Respiratory Effects (Particulates, RES)

Text taken from Bare et al. (2003, p. 66).

Ambient concentrations of particulate matter (PM) are strongly associated with changes in background rates of chronic and acute respiratory symptoms, as well as mortality rates. Ambient particulate concentrations are elevated by emissions of primary particulates, measured variously as total suspended particulates, PM less than 10 µm in diameter (PM10), PM less than 2.5 µm in diameter (PM2.5), and by emissions of SO₂ and NO_x, which lead to the formation of the so-called secondary particulates sulfate and nitrate. In TRACI, respiratory effects are computed as PM2.5 equivalents (PM2.5 eq.).

H.7 Abiotic Resource Depletion, Fossil Fuel (FF, NRPE)

Several ways of analyzing fossil fuel and energy consumption exist (Bare et al. 2003). Many of these techniques acknowledge a preference for renewable energy sources as opposed to non-renewable energy sources.

GaBi proposes a non-renewable **Primary Energy Demand** (NRPE) indicator. Primary Energy Demand is often difficult to determine due to the various types of energy sources. Primary Energy Demand is the quantity of energy directly withdrawn from the hydrosphere, atmosphere or geosphere, or energy source without any anthropogenic change. For fossil fuels and uranium, this would be the amount of resource withdrawn expressed in its energy equivalent (i.e., the energy content of the raw material). For renewable resources, the energy-characterized amount of biomass consumed would be described. For hydropower, it would be based on the amount of energy that is gained from the change in the potential energy of the water (i.e., from the height difference). The total “primary energy consumption non-renewable,” given in MJ, essentially characterizes the gain from the energy sources natural gas, crude oil, lignite, coal and uranium. Natural gas and crude oil are used both for energy production and as material constituents (e.g., in plastics). Coal is primarily used for energy production. Uranium is only used for electricity production in nuclear power stations.

TRACI (Bare et al. 2003, p. 68) argues that, although a useful measure, primary energy demand does not fully address potential depletion issues associated with energy consumption. For example, solid and liquid fuels are not perfect substitutes (i.e., solid fuels are not currently practical in personal transportation applications). For this reason, depletion of petroleum has different implications than depletion of coal, and so forth. TRACI quantifies **Fossil Fuel Depletion** (FF) by taking into account the fact that continued extraction and production of fossil fuels tends to consume the most economically recoverable reserves first, so that (assuming fixed technology) continued extraction will become more energy-intensive in the future. This is especially true once economically recoverable reserves of conventional petroleum and natural gas are consumed, leading to the need to use non-conventional fuels such as oil shale.

H.8 Renewable Primary Energy Demand (RPE)

GaBi proposes a renewable Primary Energy Demand indicator. Primary Energy Demand is often difficult to determine due to the various types of energy sources. Primary Energy Demand is the quantity of energy directly withdrawn from the hydrosphere, atmosphere or geosphere, or energy source without any anthropogenic change. For fossil fuels and uranium, this would be the amount of resource withdrawn expressed in its energy equivalent (i.e., the energy content of the raw material). For renewable resources, the energy-characterized amount of biomass consumed would be described. For hydropower, it would be based on the amount of energy that is gained from the change in the potential energy of the water (i.e., from the height difference). The total “primary energy consumption renewable,” given in MJ, is generally accounted separately and comprises hydropower, wind power, solar energy and biomass. Feedstock energy, that is the energy of raw material inputs that are not used as an energy source to a product system (e.g., wood into pulp), was not included.

H.9 Water Use and Consumption (WU, WC)

In this study, water use is defined as the water withdrawn from the environment. This is referred to as “water withdrawal” in ISO 14046 (ISO 2014). Turbine water was not included in water use. Water consumption is that portion of water withdrawn from a source that is not directly returned after use or consistent with ISO14046 (ISO 2014, p. 3) “*water removed from, but not returned to, the same drainage basin [either] because of evaporation, transpiration, integration into a product, or release into a different drainage basin or the sea*”. It is the water that is no longer available because it has been evaporated, transpired, incorporated into products, or otherwise removed from the water environment. In this report, evapotranspiration, is not accounted within water consumption. Figure 56 presents the connection of the forest products industry to the water cycle.

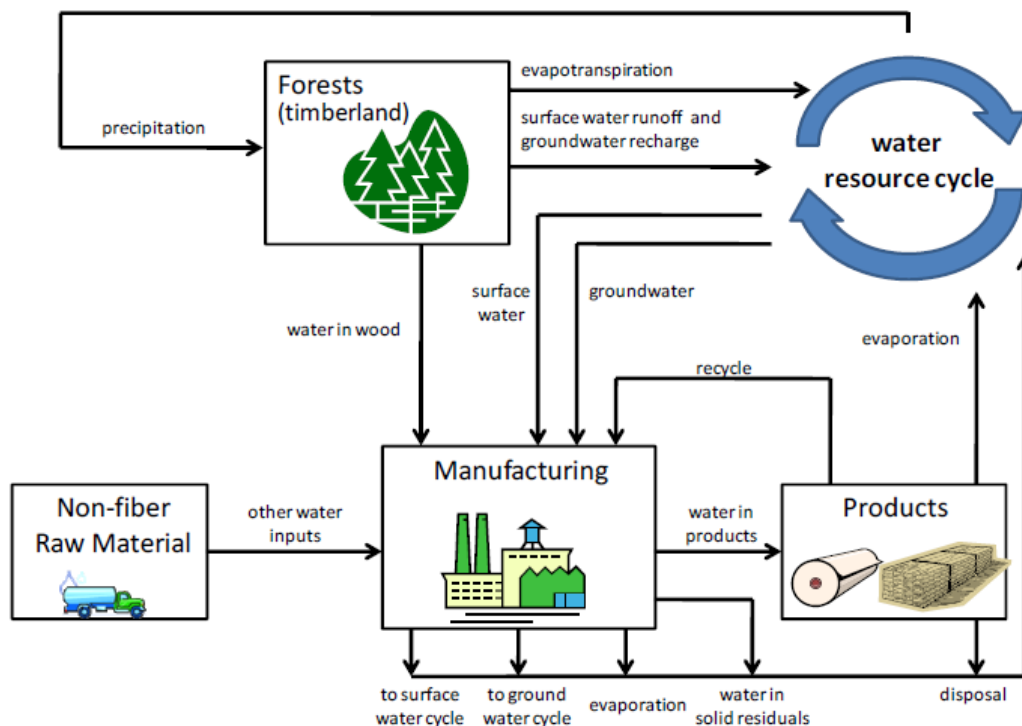

Figure 56. Connection of the Forest Products Industry to the Water Cycle

H.10 Human Toxicity (Tox) and Ecotoxicity (ECO)

Toxicity and ecotoxicity indicators attempt to quantify impacts on human health and ecosystems due to emissions of toxic substances. TRACI models impacts to human health and ecosystems based on the USEtox™ methodology (Rosenbaum et al. 2008). USEtox™ is a model based on scientific consensus for characterizing human and ecotoxicological impacts of chemicals in life-cycle impact assessment. The main output includes a database of recommended and interim characterization factors including environmental fate, exposure, and effect parameters for human toxicity and ecotoxicity. According to Rosenbaum et al. (2008), contributions of 1%, 5% or 90% to the total toxicity score are essentially equal but significantly larger than those of a chemical contributing to less than one per thousand or less than one per million of the total score. In

practice, this means that for LCA practitioners, these toxicity factors are useful to identify the ten or twenty most important toxic substances pertinent for their applications. Once these most important substances have been identified, further analysis can be carried out on the life cycle phase, application components responsible for these emissions, and the respective importance of fate, exposure and effect in determining the impacts of this chemical.

I. 2014 INDUSTRY-AVERAGE LCA RESULTS BY GHG PROTOCOL SCOPES

The GHG Protocol Corporate and Scope 3 Standard propose an interesting grouping scheme for GHGs (WRI and WBCSD 2004, 2011a). According to that scheme, GHG emissions can be classified into three main categories:

- direct emissions from owned or controlled sources (scope 1);
- indirect emissions from the generation of purchased energy (scope 2); and
- all other indirect emissions (scope 3).

Also, according to that classification scheme, biogenic CO₂ emissions and removals are reported separately. The "scope" grouping scheme typically applies for GHG inventories of organizations but can also provide useful information for an industry-average LCA.

Figure 57 depicts life cycle GHG emissions by scopes of the GHG Protocol. In that context, scope 1 includes all emissions that occur directly at pulp and paper mills or converting facilities, scope 2 includes all emissions associated with purchased energy (electricity and steam)²⁶, and scope 3 includes everything else. No information was available concerning the ownerships of forests providing the fiber, making it impossible to divide related emissions between scopes. For this reason, forestry-related emissions were included in scope 3 emissions. Biogenic CO₂ emissions and removals are displayed separately.

The following can be seen from Figure 57:

- emissions are well distributed between the three scopes;
- there are more biogenic removals than emissions because 1) some carbon is exported to other life cycles and (2) some carbon is stored in landfills; and
- net biogenic CO₂ releases are enough to offset 63% of the scope emissions.

²⁶ Note that pre-combustion emissions for purchased power and steam are typically included within Scope 3 emissions. Here they are included within Scope 2 emissions for simplification purposes.

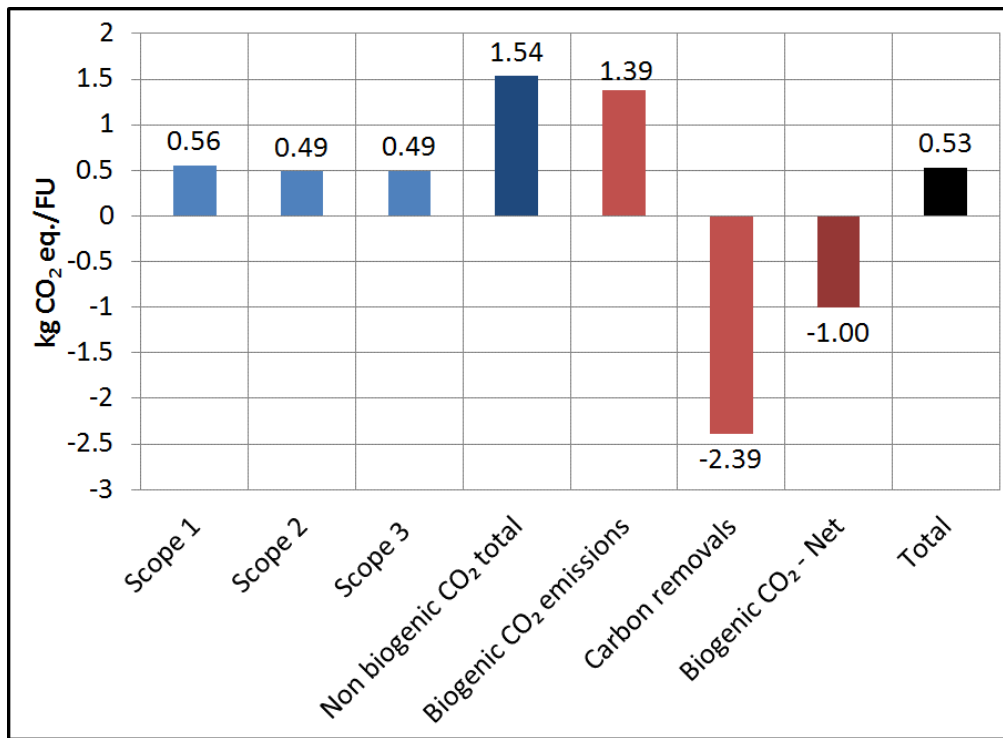

Figure 57. GHG Emissions by Scopes of the GHG Protocol

J. TOXICITY INDICATOR RESULTS

According to Rosenbaum et al. (2008), contributions of 1%, 5% or 90% to the toxicity score are essentially equal but significantly larger than those of a chemical contributing to less than one per thousand or less than one per million of the total score. For this reason, they recommend that the USEtox method be used to identify the ten or twenty most important toxic substances pertinent for their applications. Once these most important substances have been identified, further analysis can be carried out in the life cycle phase, application components responsible for these emissions, and the respective importance of fate, exposure and effect in determining the impacts of this chemical.

In this section, the substance contributing to more than 1% to toxicity categories as well as their sources are documented in no specific order. Table 58 presents the substances that contribute to more than 1% of the human health non-cancer impact category, Table 59 the substances that contribute to more than 1% of the human health cancer impact category and Table 60 the substances that contribute to more than 1% of the ecotoxicity impact category.

Table 58. Contributors to the Human Health Non-Cancer Impact Category (HHNC)

Substance	Unit processes contributors
Lead to soil	Land application of ashes and WWTP residuals
Mercury to air	Coal and spent liquor combustion at P&P mills
Mercury to soil	Coal and spent liquor combustion at P&P mills
Zinc to air	Coal and spent liquor combustion at P&P mills
Zinc to soil	Land application of ashes and WWTP residuals
Zinc to water	P&P mills effluent

Table 59. Contributors to the Human Health Cancer Impact Category (HHC)

Substance	Unit processes contributors
Arsenic to water	Coal ash management, fiber procurement
Formaldehyde to air	Wood combustion, spent liquor combustion, other P&P mills process emissions
Mercury to air	Coal and spent liquor combustion at P&P mills and electricity facilities
Mercury to soil	Coal and spent liquor combustion at P&P mills

Table 60. Contributors to the Ecotoxicity (ECO) Impact Category

Substance	Unit processes contributors
Barium to water	Production of purchased fuels, purchased electricity, fiber supply
Cadmium to water	Natural gas production
Copper to soil	Land application of ashes and WWTP residuals
Zinc to soil	Land application of ashes and WWTP residuals
Zinc to water	Landfilling of WWTP residuals

K. DETAILED PEER REVIEW COMMENTS AND ANSWERS

The next pages present the detailed critical review comments and how they were resolved.

Section	Figure/ Table	Type of comment	Reviewer comment	Reviewer recommendation	Status	NCASI response
			ISO 14044 Requirements			
		Tech	Are methods used to carry out the LCA consistent with the ISO 14040/14044 standards?			
			ISO Requirement: <i>General Aspects - LCA Commissioner, practitioner of LCA (internal or external)</i>	Requirement met.	Closed	
			ISO Requirement: <i>General Aspects - date of the report</i>	Requirement met.	Closed	
			ISO Requirement: <i>General Aspects - statement that the report has been conducted according to the requirements of ISO applicable standards (14040/14044)</i>	Requirement met.	Closed	
			ISO Requirement: <i>Goal of the study – reasons for carrying out the study.</i>	Requirement met.	Closed	
			ISO Requirement: <i>Goal of the study – its intended applications</i>	Requirement met.	Closed	
			ISO Requirement: <i>Goal of the study – its target audience</i>	Requirement met.	Closed	
			ISO Requirement: <i>Goal of the study – statement of intent to support comparative assertion to be disclosed to the public</i>	Requirement met.	Closed	
			ISO Requirement: <i>Scope of the study – function, including performance characteristics and any omission of additional functions in comparisons.</i>	Requirement met.	Closed	
			ISO Requirement: <i>Scope of the study – functional unit, including consistency with goal and scope, definition, result of performance measurement</i>	Requirement met.	Closed	

Section	Figure/ Table	Type of comment	Reviewer comment	Reviewer recommendation	Status	NCASI response
			ISO Requirement: <i>Scope of the study – system boundary including omissions of life cycle stages, processes or data needs, quantification of energy and material inputs and outputs, assumptions about electricity production.</i>	Requirement met.	Closed	
4.1.6.3			ISO Requirement: <i>Scope of the study – cut off criteria for initial inclusion of inputs and outputs, including description of cut-off criteria and assumptions, effect of selection on results, inclusion of mass, energy and environmental cut-off criteria</i>	<i>It reads: In this manner, no chemicals with significant contribution to any environmental indicator (i.e. > 5%) would be ignored. Is the estimated cumulative impact of all "cut-off" chemicals less than 5% of any environmental indicator? That should be clearly stated in the LCA report to avoid any confusions.</i>	Closed	Individual. Sentence is changed to "In this manner, no chemicals with significant individual contribution to any environmental indicator (i.e. > 5%) would be ignored."
			ISO Requirement: <i>Life Cycle Inventory Analysis – data collection procedures</i>	Requirement met.	Closed	
			ISO Requirement: <i>Life Cycle Inventory Analysis – qualitative and quantitative description of unit processes</i>	Requirement met.	Closed	
			ISO Requirement: <i>Life Cycle Inventory Analysis – sources of published literature</i>	Requirement met.	Closed	
			ISO Requirement: <i>Life Cycle Inventory Analysis – calculation procedures for relating data to unit process and functional unit (including allocation methods/issues)</i>	Requirement met.	Closed	

Section	Figure/ Table	Type of comment	Reviewer comment	Reviewer recommendation	Status	NCASI response
3.6 and 4.4			ISO Requirement: <i>Life Cycle Inventory Analysis – validation of data including data quality assessment and data gaps</i>	I recommend Data Quality should be assessed regarding the 2016 EPA Guidance on Data Quality Assessment for Life Cycle Inventory Data. https://cfpub.epa.gov/si/si_public_record_report.cfm?dirEntryId=321834 The 2016 U.S. EPA Guidance document takes priority over theecoinvent (European) one.	Closed	Data quality assessment was updated accordingly.
			ISO Requirement: <i>Life Cycle Inventory Analysis – sensitivity analysis for refining the system boundary and/or supporting conclusions</i>	Requirement met.	Closed	
			ISO Requirement: <i>Life Cycle Inventory Analysis – allocation principles and procedures, including documentation and justification of allocation procedures and uniform application of allocation procedures</i>	Requirement met.	Closed	
			ISO Requirement: <i>Life Cycle Impact Assessment - impact categories and category indicators considered, including a rationale for their selection and a reference to their source.</i>	Requirement met.	Closed	

Section	Figure/ Table	Type of comment	Reviewer comment	Reviewer recommendation	Status	NCASI response
			ISO Requirement: <i>Life Cycle Impact Assessment - descriptions/reference to all characterization models, characterization factors and methods used including assumptions and limitations</i>	Water use and water consumption (section H.9). I recommend this section be updated by using a ISO 14046 standard terminology to address water use and consumption. ISO 14046:2014 Environmental management -- Water footprint -- Principles, requirements and guidelines https://www.iso.org/standard/43263.html	Closed	Industry is used to the "water use" and "water consumption" terminology. Hence, we prefer not to change this terminology. This is also what was used in the previous studies. However, we modified section H.9 to make the parallel with ISO 14046. Also, we added the ISO 14046 nomenclature in the list of abbreviations.
			ISO Requirement: <i>Life Cycle Impact Assessment - relationship of the LCIA results to the LCI results</i>	Requirement met.	Closed	
			ISO Requirement: <i>Life Cycle Impact Assessment - limitations of the LCIA results to the defined goal and scope</i>	Requirement met.	Closed	
			ISO Requirement: <i>Life Cycle Impact Assessment - relationship of LCIA results to the defined goal and scope</i>	Requirement met.	Closed	
			ISO Requirement: <i>Life Cycle Impact Assessment - descriptions of or reference to all value-choices</i>	Requirement met.	Closed	
			ISO Requirement: <i>Life Cycle Impact Assessment – a statement that the LCIA results are relative expressions and do not predict impacts on category endpoints, the exceeding of thresholds, safety margins or risks.</i>	Requirement met.	Closed	
			ISO Requirement: <i>Life Cycle Interpretation – summary of the results</i>	Requirement met.	Closed	

Section	Figure/ Table	Type of comment	Reviewer comment	Reviewer recommendation	Status	NCASI response
			ISO Requirement: <i>Life Cycle Interpretation – assumptions and limitations associated with the interpretations of results, both methodology and data related</i>	Requirement met.	Closed	
			ISO Requirement: <i>Life Cycle Interpretation – data quality assessment and uncertainty analyses</i>	Requirement met.	Closed	
			ISO Requirement: <i>Life Cycle Interpretation – full transparency in terms of value-choices, rationales and expert judgments</i>	Requirement met.	Closed	
			ISO Requirement: <i>Critical Review – name and affiliation of reviewers</i>	Requirement met.	Closed	
		Tech	Are methods used to carry out the LCA scientifically and technically valid?	Requirement met	Closed	
		Tech	Are data used appropriate and reasonable in relation of the goal of the study?	Requirement met	Closed	
		Tech	Do interpretations reflect the limitations identified and the goal of the study?	Requirement met	Closed	
		Tech	Is study report transparent and consistent?	Requirement met	Closed	
			Line by Line Review Comments			

Section	Figure/ Table	Type of comment	Reviewer comment	Reviewer recommendation	Status	NCASI response
LCA Report		Tech	<p>NCASI 2017 is an update of the NCASI 2014 LCA report. The same study goals & scope, LCI technical procedures, LCA methodology, and LCA reporting and interpretation structure and elements are applied for this update. NCASI 2014 LCA report was reviewed by a panel of experts. The majority of LCA technical and general comments were already clarified and addressed back in 2014.</p> <p>http://www.corrugated.org/upload/CPA/Documents/2010_LCA_Final_Report_NCASI_August2014.pdf In accordance with ISO 14044, Clause 4.2.3.8, LCA commissioner has decided NCASI 2017 LCA report will be reviewed by one external reviewer.</p>	n/a	Closed	
ES.1		Ed	<p>It reads: <i>The study being an update of the 2010 LCA published in 2013</i>; NCASI 2010 LCA report was issued in <u>April 2014</u>.</p>	Update accordingly	Closed	Corrected.
	Figure 1	Ge	<p>Inputs and outputs do not balance for S2. S2: inputs= 1.10 kg; outputs=1.13 kg (1.00+0.13); I suggest you add the note for S2: <i>mass balance difference is due to additives</i>. S3: inputs=1.00 kg; outputs: 1.01 kg Recycling: Input = 1.03 (0.13 +0.90); Output= 1.02 I suggest you add the note for S3 and recycling: <i>mass balance difference is due to rounding</i>. A lay person might find it difficult to explain the differences.</p>	Update accordingly	Closed	Done.
	Table 1	Ge	Add a note - <i>difference is due to rounding</i> .	Update accordingly	Closed	Done.

Section	Figure/ Table	Type of comment	Reviewer comment	Reviewer recommendation	Status	NCASI response
ES.4.4 and more		Ge	I suggest replacing the term “meaningful” with “significant” throughout the LCA report; ISO 14044 uses the term “significant”;	Update accordingly	Closed	We had this discussion internally. We used significant in previous reports but it was suggested that significant would normally be understood as "statistically significant". We did not apply statistics to determine the significance of the difference.
3.5		Ge	<p>The new North American Product Category Rules (PCR) document is up for public comments till May 24th and is expected to be published soon: Product Category Rules for North American Market Pulp, Paper and Paperboard Products, Tissue, and Containerboard.</p> <p>http://publicreview.csa.ca/Document/Manage/2562</p> <p>As per PCR, <i>economic allocation</i> is set as baseline. In NCASI 2017, <i>mass allocation</i> is applied for e.g. sawmill co-products. As per mass allocation, wood chips (by-product of lumber production) receive a larger environmental burden (around 40%); As per economic allocation, wood chips will receive a lower burden (around 10%);</p> <p>If CPA would wish to publish an Environmental Product Declaration (EPD) of U.S. AVERAGE CORRUGATED PRODUCT based on NCASI 2017 LCA report, then the LCA team shall follow the North American PCR requirements.</p> <p>As it stands now, NCASI 2017 LCA report does not fulfill all PCR requirements (e.g. for allocation rules, selected LCIA & LCI indicators, etc.). NCASI 2017 LCA results can not be used for the potential purpose of an industry average EPD as per 2017 NA PCR (Btw, I am aware, this item is not listed in section 2- Goal of the study).</p>	<p><i>It is ultimately the CPA's decision</i>, but my recommendation would be, the LCA team should conduct a sensitivity scenario by following the PCR rules and report the LCA/LCI results as per PCR requirements in a separate section.</p> <p>This could also potentially be a new item of work for NCASI in the near future.</p>	Closed	While we understand your concern, the PCR is still at a draft stage and may well change. Also, the issue with economic allocation is that the allocation factors vary with time, which makes it difficult to communicate the results in the case of a study that is intended to follow progress in time. In addition, mass allocation would still be needed to close the carbon balances. Finally, when applying economic allocation, chips will have a lower environmental impact. Hence the approach applied is conservative. For these reasons, we decided not to apply economic allocation.

Section	Figure/ Table	Type of comment	Reviewer comment	Reviewer recommendation	Status	NCASI response
4.1.2		Ge	It reads: <i>Finally, the ecoinvent 2 database (Frischknecht et al. 2005) was used to fill any remaining data gaps. ecoinvent 2 was released in 2007. ecoinvent 3 LCI dataset should be used for this LCA study.</i>	Update accordingly	Closed	Very few datasets from ecoinvent were used and these were not updated to the latest version due to the amount of work that would be needed. These datasets were compared to the ecoinvent v.3 database and they did not differ in a way that would have impacted the results of the study.
	Table 13		1. For wood products and by-products, it's important to specify if you are referring to oven-dry weight; or report the moisture content in %; 2. Mixing SI with non-SI units in one table is confusing; I suggest reporting the HHVs in both formats (e.g. MJ/kg) and (BTU/lbs); Mixing both systems e.g. MJ/gal is not recommended.	Update accordingly	Closed	1. Done. 2. All converted to metric.
	Table 14		Starch is removed from the list. What's the rationale for that?	Update accordingly	Closed	An omission. Added.
4.1.6.3			it reads: caustic. Specify e.g., caustic soda, caustic potash, or caustic lime. It's missing.	Update accordingly	Closed	It is meant "sodium hydroxide". Added.
	Table 15		Specify if the woody material inputs refer to od weight.	Update accordingly	Closed	Specified.
	Table 19		Provide a note that 2010 data are revised.	Update accordingly	Closed	Added.
	Table 24		Since you haven't used TRACI or CML climate change factors, I recommend you append (e.g. Annex J) the IPCC 2013, Table 8.A.1 Global Warming factors and provide a weblink to GWPs in Table 24.	Update accordingly	Closed	We added a link. We considered that having them all listed would not be useful. However, GWPs for CH4 and N2O are provided. Listing is not necessary.

Section	Figure/ Table	Type of comment	Reviewer comment	Reviewer recommendation	Status	NCASI response
5.2.3			It reads: IPCC 2014 GWPs ... Is it IPCC 2014 or 2013 GWPs?	Update accordingly	Closed	Changed to IPCC AR5 GWPs.
6	Table 26		Similar to Table 38, I suggest you report all three Global warming indicators: -Global warming, flow accounting -Global warming, stock change accounting -Global warming, excluding biogenic CO2 It contributes to a higher transparency of the LCA results.	Update accordingly	Closed	Done.
6.3.4			it reads: 6.3.4 Recovery Rate (S5) it should read: 6.3.4 Recovery Rate (S4)	Update accordingly	Closed	Changed.

L. LIST OF REFERENCES

Abt, K.L., Abt, R.C. and Galik, C. 2012. Effect of Bioenergy Demands and Supply Response on Markets, Carbon, and Land Use. *Forest Science* 58(5):523-539.

American Forest & Paper Association. 1996. *Life Cycle Inventory Analysis User's Guide - Enhanced Methods and Applications for the Products Industry*. International Working Group.

American Forest & Paper Association (AF&PA). 1996. *Life Cycle Inventory Analysis User's Guide - Enhanced Methods and Applications for the Products Industry*. International Working Group.

———. 2009. *2009 Annual Statistical Summary of Recovered Paper Utilization*. Washington D.C.: AF&PA.

———. 2015. *55th Annual Capacity & Fiber Consumption Survey*. Washington: AF&PA.

Bare, J.C., Norris, G.A., Pennington, D.W. and McKone, T. 2003. TRACI: The tool for the reduction and assessment of chemical and other environmental impacts. *Journal of Industrial Ecology* 6(3-4):49-78.

Baumann, H. 1996. LCA Use in Swedish Industry. *International Journal of Life Cycle Assessment* 1(3):122-126.

Baumann, H. and Tillman, A.-M. 2004. *The Hitch Hiker's Guide to LCA*. Lund: Studentlitteratur.

Bergman, R. and Bowe, S. 2010. Environmental Impact of Manufacturing Softwood Lumber in Northeastern and North Central United States. *Wood and Fiber Science* 42(0):67-78.

Clark, E.D., Hamilton, F.R. and Kleineau, J.R. 1987. Economics of Secondary Fibers. In *Secondary Fibers and Non-Wood Pulp*. Hamilton Frank, Leopold, B. and Kokurek, M.J. pp. 156. Atlanta: The Joint Textbook Committee of the Paper Industry TAPPI CPPA.

Daigneault, A., Sohngen, B. and Sedjo, R. 2012. Economic Approach to Assess the Forest Carbon Implications of Biomass Energy. *Environmental Science & Technology* 46(11):5664-5671.

Edelen, A. and Ingwersen, W. 2016. *Guidance on Data Quality Assessment for Life Cycle Inventory Data (Version 1)*. EPA/600/R-16/096. Cincinnati, OH: United States Environment Protection Agency (U.S. EPA).

Ekvall, T. 1999. Key methodological issues for life cycle inventory analysis of paper recycling. *Journal of Cleaner Production* 7(4):281-294.

Ekvall, T. and Finnveden, G. 2001. Allocation in ISO 14041--a critical review. *Journal of Cleaner Production* 9(3):197-208.

- Ekvall, T. and Tillman, A.-M. 1997. Open-Loop Recycling: Criteria for Allocation Procedures. *International Journal of Life Cycle Assessment* 2(3):155-162.
- Ekvall, T., Tillman, A.M. and Molander, S. 2005. Normative ethics and methodology for life cycle assessment. *Journal of Cleaner Production* 13(13-14):1225-1234.
- Ekvall, T. and Weidema, B.P. 2004. System boundaries and input data in consequential life cycle inventory analysis. *International Journal of Life Cycle Assessment* 9(3):161-171.
- European Commission - Joint Research Centre - Institute for Environment and Sustainability. 2011. *International Reference Life Cycle Data System (ILCD) Handbook - Recommendations for Life Cycle Impact Assessment in the European Context. First Edition*. EUR 24571 EN. Luxembourg.: Publications Office of the European Union.
- European Commission - Joint Research Centre - Institute for Environment and Sustainability (EC-JRC-IES). 2010. *International Reference Life Cycle Data System (ILCD) Handbook - General guide for Life Cycle Assessment - Detailed guidance (First edition)*. 1st Edition. EUR 24708 EN. Luxembourg: Publications Office of the European Union.
- Fibre Box Association. 2015. *2014 Fibre Box Association Annual Report*. Fibre Box Association.
- Franklin Associates. 2004. *Life cycle inventory of packaging options for shipment of retail mail-order soft goods - Final peer-reviewed report*. Prairie Village, KS:
- Frischknecht, R., Jungbluth, N., Althaus, H.-J., Doka, G., Dones, R., Heck, T., Hellweg, S., Hischer, R., Nemecek, T., Rebitzer, G. and Spielmann, M. 2005. The ecoinvent database: Overview and methodological framework. *International Journal of Life Cycle Assessment* 103-9.
- Galeano, S.F., Smorch, P.M. and Richardson P.E., M.S. 2011. Application of Life Cycle Assessment to Supply Optimization. In *ISIE 2011 Conference: 6th International Conference on Industrial Ecology*. Berkeley, California: International Society for Industrial Ecology,
- Galik, C.S. and Abt, R.C. 2012. *The Effect of Assessment Scale and Metric Selection on the Greenhouse Gas Benefits of Woody Biomass*. NI WP 12-02. Nicholas Institute for Environmental Policy Solutions, Duke University.
<https://nicholasinstitute.duke.edu/climate/lowcarbontech/near-term-market-and-ghg-implications-of-forest-biomass-in-southeast#.VgrS4v1Viko> (accessed
- Guinee, J.B., Goree, M., Heijungs, R., Huppes, G., Kleijn, R., Koning, A.d., Oers, L.v., Wegener Sleeswijk, A., Suh, S., Udo de Haes, H.A., Bruijn, H.d., Duin, R.v. and Huijbregts, M.A.J. 2002. *Handbook on life cycle assessment. Operational guide to the ISO standards. I: LCA in perspective. Iia: Guide. Iib: Operational annex. III: Scientific background*. Dordrecht: Kluwer Academic Publishers.
- Hardie, I., Parks, P., Gottlieb, P. and Wear, D. 2000. Responsiveness of Rural and Urban Land Uses to Land Rent Determinants in the U.S. South. *Land Economics* 76(4):659-673.

Humbert, S., Rossi, V., Margni, M., Jolliet, O. and Loerincik, Y. 2009. Life cycle assessment of two baby food packaging alternatives: glass jars vs. plastic pots. *The International Journal of Life Cycle Assessment* 14(2):95-106.

International Energy Agency (IEA). 2016. *Electricity/Heat in Mexico in 2013*. <https://www.iea.org/statistics/statisticssearch/report/?country=MEXICO&product=electricityandheat&year=2013> (accessed 11 July 2016).

International Organization for Standardization (ISO). 2006a. *Environmental management - Life cycle assessment - Principles and framework*. ISO 14040. Geneva: International Organization for Standardization.

———. 2006b. *Environmental management - Life cycle assessment - Requirements and guidelines*. ISO 14044. Geneva: International Organization for Standardization.

———. 2012a. *Environmental management - Life cycle assessment - Illustrative examples on how to apply ISO 14044 to impact assessment situations*. ISO/TR 14047. Geneva: ISO.

———. 2012b. *Environmental management — Life cycle assessment — Illustrative examples on how to apply ISO 14044 to goal and scope definition and inventory analysis*. ISO/TR 14049. Geneva: ISO.

———. 2014. *Environmental management — Water footprint — Principles, requirements and guidelines*. ISO 14046. Geneva: ISO.

IPCC. 2006a. *2006 IPCC Guidelines for National Greenhouse Gas Inventories* (eds.)). Volume 4 Agriculture, Forestry and Other Land Use. Institute for Global Environmental Strategies. <http://www.ipcc-nggip.iges.or.jp/public/2006gl/vol4.html> (accessed 09 July 2009).

———. 2006b. *2006 IPCC Guidelines for National Greenhouse Gas Inventories* (eds.)). Volume 5 Waste. Institute for Global Environmental Strategies. <http://www.ipcc-nggip.iges.or.jp/public/2006gl/vol5.html> (accessed 09 July 2009).

———. 2013. Contribution of Working Group I to the Fifth Assessment Report of the Intergovernmental Panel on Climate Change. *In Climate Change 2013: The Physical Science Basis*. . Stocker, T.F., Qin, D., Plattner, G.-K., Tignor, M., Allen, S.K., Boschung, J., Nauels, A., Xia, Y., Bex, V. and Midgley, G.F. pp. Cambridge, United Kingdom Cambridge University Press

Johnson, L., Lippke, B. and Oneil, E. 2012. Modeling Biomass Collection and Woods Processing Life-Cycle Analysis. *Forest Products Journal* 62(4):258-272.

Johnson, L.R., Lippke, B., Marshall, J.D. and Connick, J. 2004. Module A: Forest Resources Pacific Northwest and Southeast. *In CORRIM: Phase I Final Report*. pp. 72.

Kline, D.E. 2004. Module E: Southeastern Oriented Strandboard Production. *In CORRIM: Phase I Final Report*. pp. 75.

- Lubowski, R.N., Plantinga, A.J. and Stavins, R.N. 2008. What Drives Land-Use Change in the United States? A National Analysis of Landowner Decisions. *Land Economics* 84(4):529-550.
- Milota, M.R. 2004. Module B: Softwood Lumber Pacific Northwest Region. In CORRIM: Phase I Final Report. pp. 94.
- Milota, M.R., West, C.D. and Hartley, I.D. 2004. Module C: Softwood Lumber - Southeast Region. In CORRIM: Phase I Final Report. pp. 94.
- Miner, R. 2006. The 100-Year Method for Forecasting Carbon Sequestration in Forest Products in Use. *Mitigation and Adaptation Strategies for Global Change* Published online (DOI: 10.1007/s11027-006-4496-3).
- National Council for Air and Stream Improvement, Inc. (NCASI). 2001. *NCASI of Chemical-Specific Information for Sara Section 313 Form R Reporting*. Research Triangle Park, NC: National Council for Air and Steam Improvement, Inc.
- . 2005. *Calculation Tools for Estimating Greenhouse Gas Emissions from Pulp and Paper Mills*. Version 1.1. Research Triangle Park, NC: National Council for Air and Stream Improvement, Inc. , International Council of Forest and Paper Associations.
- . 2008. *Estimating Water Consumption at Pulp and Paper Mills*. Technical Bulletin No. 946. Research Triangle Park, NC: National Council for Air and Steam Improvement, Inc.
- . 2010. *Life cycle assessment of North American printing and writing paper products (unpublished)*. Unpublished report. Research Triangle Park, NC: National Council for Air and Steam Improvement, Inc.
- . 2011. *Summary of the Literature on the Treatment of Paper and Paper Packaging Products Recycling in Life Cycle Assessment*. Technical Bulletin 0985. Research Triangle Park, NC: National Council for Air and Steam Improvement, Inc.
- . 2012. *Methods for Open-Loop Life Recycling in Life Cycle Assessment and Carbon Footprint Studies of Paper Products*. Technical Bulletin No. 1003. Research Triangle Park, NC: National Council for Air and Stream Improvement, Inc.
- . 2013a. *Greenhouse gas and fossil fuel reduction benefits of using biomass manufacturing residuals for energy production in forest products manufacturing facilities*. Technical Bulletin no. 1015. Research Triangle Park, NC: National Council for Air and Steam Improvement, Inc.
- . 2013b. *A Review of Biomass Carbon Accounting Methods and Implications*. Technical Bulletin no. 1015. Research Triangle Park, NC: National Council for Air and Steam Improvement, Inc.
- . 2015. *Master Summary Table of NCASI Emission Factors for Pulp and Paper Mills - Air Toxics*. Cary, NC:

National Renewable Energy Laboratory (NREL). 2012. *U.S. LCI Database*.
<https://www.lcacommons.gov/nrel/search> (accessed 23 June 2015).

Oneil, E., Johnson, L., Lippke, B., McCarter, J., McDill, M., Roth, P. and Finley, J. 2010. Life-Cycle impacts of Inland Northwest and Northeast/North central forest resources. *Wood and Fiber Science* 42(0):29-51.

PE INTERNATIONAL AG. 1992-2013. *GaBi 6, Software-System and Databases for Life Cycle Engineering, Copyright, TM*. Stuttgart, Echterdingen: PE.

Puettmann, M., Wagner, F. and Johnson, L. 2010. Life Cycle Inventory of Softwood Lumber from the Inland Northwest US. *Wood and Fiber Science* 42(0):52-66.

Rosenbaum, R., Bachmann, T., Gold, L., Huijbregts, M., Jolliet, O., Juraske, R., Koehler, A., Larsen, H., MacLeod, M., Margni, M., McKone, T., Payet, J., Schuhmacher, M., van de Meent, D. and Hauschild, M. 2008. USEtox—the UNEP-SETAC toxicity model: recommended characterisation factors for human toxicity and freshwater ecotoxicity in life cycle impact assessment. *The International Journal of Life Cycle Assessment* 13(7):532-546.

Statistics Canada. 2016a. *Electric power generation, by class of electricity producer*. Table 127-0002. Ottawa: CANSIM (database).

<http://www5.statcan.gc.ca/cansim/a26?lang=eng&id=1270002> (accessed 11 July 2016).

———. 2016b. *Electricity generated from fossil fuels*. Table 127-0014. Ottawa: CANSIM (database). <http://www5.statcan.gc.ca/cansim/a26?lang=eng&id=1280014> (accessed 11 July 2016).

———. 2016c. *Supply and disposition of electric power, electric utilities and industry*. Table 127-0008. Ottawa: CANSIM (database).

<http://www5.statcan.gc.ca/cansim/a26?lang=eng&id=1270008> (accessed 11 July 2016).

thinkstep. 1992-2016. *GaBi Software-System and Database for Life Cycle Engineering, Copyright*. Stuttgart, Echterdingen: PE.

Tillman, A.-M. 2000. Significance of decision-making for LCA methodology. *Environmental Impact Assessment Review* 20(1):113-123.

U.S. Energy Information Administration (EIA). 2015. *Electricity Detailed State Data*.
<http://www.eia.gov/electricity/data/state/> (accessed 11 July 2016).

United States Department of Transportation and United States Department of Commerce. 2010. *2007 Economic Census - Transportation - Commodity Flow Survey*.

———. 2015. *2012 Economic Census - Transportation - Commodity Flow Survey*. EC12TCF-US.

United States Environmental Protection Agency (U.S. EPA). 1997. *Air Emissions from Scrap Tire Combustion*. Springfield, VA: EPA.

———. 2014. *Municipal Solid Waste Generation, Recycling, and Disposal in the United States - Tables and Figures for 2012*. Washington, DC: U.S. EPA.

https://www.epa.gov/sites/production/files/2015-09/documents/2012_msw_dat_tbls.pdf (accessed 07 July 2016).

———. 2015. *Advancing Sustainable Materials Management: Facts and Figures 2013*. EPA530-R-15-002. Washington, DC: U.S. EPA.

https://www.epa.gov/sites/production/files/2015-09/documents/2013_advncng_smm_rpt.pdf (accessed 06 July 2016).

———. 2016a. *Advancing Sustainable Materials Management: 2014 Tables and Figures*.

Washington, DC: U.S. EPA. https://www.epa.gov/sites/production/files/2016-11/documents/2014_smm_tablesfigures_508.pdf (accessed 27 January 2017).

———. 2016b. *Inventory of U.S. Greenhouse Gas Emissions and Sinks: 1990-2014*.

Washington, DC: U.S. EPA. <https://www3.epa.gov/climatechange/Downloads/ghgemissions/US-GHG-Inventory-2016-Main-Text.pdf> (accessed 11 July 2016).

United States Environmental Protection Agency (USEPA). 2010. Code of Federal Regulations (CFR) Title 40, Subpart C. *Federal Register* 75(242):79091-79171.

———. 2013. *Emissions & Generation Resource Integrated Database (eGRID), version 1.0*.

<http://www.epa.gov/cleanenergy/energy-resources/egrid/> (accessed July 2013).

Wang, X., Padgett, J.M., De la Cruz, F.B. and Barlaz, M.A. 2011. Wood Biodegradation in Laboratory-Scale Landfills. *Environmental Science & Technology* 45(16):6864-6871.

Weidema, B.P., Bauer, C., Hischer, R., Mutel, C., Nemecek, T., Reinhard, J., Vadenbo, C.O. and Wernet, G. 2013. *Overview and methodology. Data quality guideline for the ecoinvent database version 3*. ecoinvent report no. 1(v3). St. Gallen: The ecoinvent Centre.

Werner, F. 2005a. *Ambiguities in Decision-oriented Life Cycle Inventories The Role of Mental Models and Values* Dordrech, The Netherlands: Springer.

———. 2005b. Chapter 5: Analysis of ISO 14041 for Mental Models and Values. *In* *Ambiguities in Decision-oriented Life Cycle Inventories The Role of Mental Models and Values* pp. 87-133. Springer.

Wilson, J.B. and Sakimoto, E.T. 2004. Module D: Softwood Plywood Manufacturing. *In* CORRIM: Phase I Final Report. pp. 87.

World Resources Institute (WRI) and World Business Council for Sustainable Development (WBCSD). 2004. *A Corporate Accounting and Reporting Standard - Revised Edition*. Geneva:

———. 2006. *Allocation of Emissions from a Combined Heat and Power (CHP) Plant*. Washington, D.C.: WRI/WBCSD.

———. 2011a. *Corporate Value Chain (Scope 3) Accounting and Reporting Standard*. GHG Protocol.

———. 2011b. *Product Life Cycle Accounting and Reporting Standard*. GHG Protocol.